

**AIR COMBAT COMMAND (ACC)**  
**AIR EDUCATION AND TRAINING COMMAND (AETC)**  
**NATIONAL GUARD BUREAU (NGB)**  
**PACIFIC AIR FORCES (PACAF)**  
**UNITED STATES AIR FORCES IN EUROPE (USAFE)**

**MULTI-COMMAND HANDBOOK 11-F16**  
**VOLUME 5**  
**EFFECTIVE DATE: 10 MAY 1996**

Before printing this document, highlight the table of contents and hit F9 to update the page numbers.

*Flying Operations*  
**F-16 COMBAT AIRCRAFT FUNDAMENTALS**

This handbook provides F-16 pilots a single-source, comprehensive document containing fundamental employment procedures and techniques that may be used to accomplish the various missions of the F-16. This handbook is the primary F-16 fighter fundamentals reference document for Air Combat Command (ACC), Pacific Air Forces (PACAF), United States Air Forces in Europe (USAFE), Air Force Reserve (USAFR), Air National Guard (ANG), and Air Education and Training Command (AETC). The procedures and techniques are presented for pilot consideration in planning and are not for regulatory purposes. Other procedures and techniques may be used if they are safe and effective. This handbook applies to ANG units when published in ANGIND2.

Designed to be used in conjunction with MCM 3-1 (S) and AFI/MCI 11-series directives, this handbook addresses basic flying tasks and planning considerations for both the air-to-air and air-to-surface arenas. It presents a solid foundation on which effective tactics can be developed. This handbook is not designed to be used as a step-by-step checklist of how to successfully employ fighters, but rather provides information and guidelines on basic procedures and techniques.

*NOTE:* Contact HQ ACC/DOT before releasing this document to a foreign government or contractor.

**Supersedes MCM 3-3 Volume 5, 1 September 1992**

**Certified by:** HQ ACC DOT (Col Thomas G. Sullivan)  
HQ AETC/XO (Maj Gen Donald L. Peterson)  
NGB/XO (Col John W. Gorman)  
HQ PACAF/DO (Maj Gen John M. McBroom)  
HQ USAFE/ADO (Col Victor E. Renuart, Jr.)

**OPR:** HQ ACC/DOT (Maj Michael K. Updike)

**Pages:** 295 / **Distribution:** F

**Approved by:** HQ ACC/ADO (Col D. L. Johnson)

---

<b>Chapter One—INTRODUCTION</b>	<b>8</b>
1.1. OVERVIEW.....	8
1.2. PURPOSE.....	8
1.3. CHANGE PROCEDURES .....	8
<b>Chapter Two—PREPARATION</b>	<b>8</b>
2.1. INTRODUCTION.....	8
2.2. ESTABLISHING PRIORITIES.....	8
2.3. PRIORITIZING TASKS .....	9
2.4. PSYCHOLOGICAL CONSIDERATIONS .....	9
2.5. PHYSIOLOGICAL CONSIDERATIONS .....	9
2.6. MISSION OBJECTIVES .....	10
2.7. MISPRIORITIZATION .....	11
2.8. SITUATION AWARENESS .....	11
2.9. FLIGHT LEADERSHIP .....	11
2.10. WINGMAN RESPONSIBILITIES .....	11

2.11. MISSION PREPARATION .....	11
2.12. DEBRIEFING.....	13
<b>Chapter Three—FORMATION</b>	<b>13</b>
3.1. BASIC FORMATION.....	13
3.2. TACTICAL FORMATION.....	19
3.3. TWO-SHIP FORMATIONS.....	24
3.4. FOUR-SHIP FORMATIONS.....	27
3.5. THREE-SHIP FORMATIONS.....	31
3.6. TACTICAL TURNS.....	32
<b>Chapter Four—AIR-TO-AIR</b>	<b>36</b>
4.1. INTRODUCTION.....	36
4.2. PREPARATION.....	36
4.3. AIRCRAFT HANDLING CHARACTERISTICS (AHC).....	36
4.4. WEAPON SYSTEMS CHECK.....	36
4.5. FENCE CHECK.....	37
4.6. PRINCIPLES/CONCEPTS OF BASIC FIGHTER MANEUVERS (BFM).....	39
4.7. OFFENSIVE BFM.....	60
4.8. DEFENSIVE BFM.....	69
4.9. HIGH ASPECT BFM.....	77
4.10. AIR COMBAT MANEUVERS (ACM).....	82
4.11. 2 V 1 DEFENSIVE VISUAL MANEUVERING .....	94
4.12. HIGH-ASPECT ACM.....	104
4.13. INTERCEPTS.....	105
4.14. GUN EMPLOYMENT.....	110
<b>Chapter Five—AIR-TO-SURFACE</b>	<b>119</b>
5.1. THE AIR-TO-SURFACE MISSION.....	119
5.2. PREPARATION.....	120
5.3. AIR-TO-GROUND MISSION PLANNING.....	120
5.4. SURFACE ATTACK CHECKS.....	123
5.5. INGRESS/EGRESS.....	125
5.6. COMPUTED VISUAL BOMBING.....	127
5.7. MANUAL WEAPONS DELIVERY .....	135
5.8. TACTICAL CONSIDERATIONS .....	146
5.9. STRAFE .....	147
5.10. TAPE ASSESSMENT AND FOOT PRINT DATA .....	150
5.11. NONVISUAL BOMBING.....	150
5.12. SYSTEM ALTITUDE ERRORS.....	159
5.13. CONTROLLED RANGE PATTERNS.....	164
5.14. POP-UP DELIVERIES .....	172
5.15. POP-UP PLANNING .....	176
5.16. FLYING A TACTICAL POP-UP.....	180
5.17. POP-UP FORMULAS .....	186
5.18. FLYUP ATTACKS .....	191
5.19. TWO SHIP EMPLOYMENT CONSIDERATIONS.....	192
5.20. EGRESS .....	202
5.21. RECOVERY.....	204
<b>Chapter Six—AIR REFUELING</b>	<b>205</b>
6.1. INTRODUCTION.....	205
6.2. MISSION PREPARATION .....	205
6.3. GROUND OPERATIONS.....	205

6.4. EN ROUTE .....	205
6.5. RENDEZVOUS.....	205
6.6. RENDEZVOUS OVERRUN .....	206
6.7. OBSERVATION POSITION .....	207
6.8. PREREFUELING CHECKS.....	207
6.9. PRECONTACT POSITION.....	207
6.10. CONTACT POSITION .....	207
6.11. MAINTAINING CONTACT .....	207
6.12. DISCONNECT .....	208
6.13. AIR REFUELING EMERGENCY PROCEDURES .....	208
6.14. POST REFUELING.....	209
<b>Chapter Seven—LOW ALTITUDE OPERATIONS</b>	<b>214</b>
7.1. INTRODUCTION .....	214
7.2. LOW ALTITUDE MAPS .....	214
7.3. LOW LEVEL ROUTE STUDY.....	214
7.4. LOW ALTITUDE AWARENESS .....	214
7.5. LOW ALTITUDE TASK PRIORITIZATION.....	215
7.6. LOW ALTITUDE INTERCEPT CONSIDERATIONS .....	215
7.7. LOW LEVEL NAVIGATION .....	216
7.8. LOW ALTITUDE MANEUVERING .....	219
7.9. EMERGENCIES/ABNORMAL OPERATIONS AT LOW ALTITUDE .....	223
7.10. ROUTE ABORT PROCEDURES.....	223
7.11. LOW ALTITUDE FORMATIONS .....	223
<b>Chapter Eight—NIGHT OPERATIONS</b>	<b>223</b>
8.1. INTRODUCTION .....	223
8.2. PHYSIOLOGICAL CONSIDERATIONS .....	223
8.3. NIGHT GROUND OPERATIONS .....	224
8.4. NIGHT TAKEOFF .....	224
8.5. NIGHT FORMATION .....	224
8.6. NIGHT/WEATHER INTERCEPTS.....	226
8.7. NIGHT SURFACE ATTACK .....	227
8.8. NIGHT LANDING .....	234
8.9. NIGHT REFUELING .....	235
8.10. IN-FLIGHT DISTRESS SIGNALS--NIGHT VISUAL (AFI 11-205).....	235
<b>Chapter Nine—PROFICIENCY EXERCISES</b>	<b>235</b>
9.1. INTRODUCTION .....	235
9.2. G-AWARENESS .....	235
9.3. ANTI-G STRAINING MANEUVER (AGSM) .....	236
9.4. AIRCRAFT HANDLING EXERCISES AND MANEUVERS.....	239
9.5. FIGHTER PROFICIENCY EXERCISES.....	250
9.6. LOW ALTITUDE TRAINING.....	258
9.7. FLAME-OUT APPROACH (FO) TECHNIQUES AND PROCEDURES .....	261
<b>Chapter Ten—LANTIRN</b>	<b>263</b>
10.1. THE LANTIRN SYSTEM .....	263
10.2. LANTIRN EFFECTS ON PERFORMANCE .....	263
10.3. ROUTE PLANNING .....	264
10.4. TARGET AREA MISSION PLANNING .....	267
10.5. GROUND OPERATIONS.....	271
10.6. TFR IN-FLIGHT CHECK.....	272
10.7. EN ROUTE CRUISE.....	273

10.8. TFR MODES OF OPERATION.....	273
10.9. LOW LEVEL OPERATIONS .....	274
10.10. THREAT REACTION .....	275
10.11. LOW ALTITUDE LANTIRN ATTACK OPTIONS.....	276
10.12. ESCAPE MANEUVERS.....	280
10.13. MEDIUM ALTITUDE INGRESS AND FLIR ATTACKS .....	281
10.14. THE RETURN TO BASE (RTB) PHASE .....	284
10.15. RADIO CALLS.....	284
<b>Attachment One—ABBREVIATIONS, ACRONYMS, AND SYMBOLS</b>	<b>285</b>
<b>Attachment Two—GLOSSARY</b>	<b>291</b>
<b>Attachment Three—CODE AND BREVITY WORDS</b>	<b>297</b>
Figure 3.1 F-16 Canopy Codes .....	20
Figure 3.2 Six O’Clock Visual Coverage.....	21
Figure 3.3 Aircraft References for Six O’Clock Look Angles.....	21
Figure 3.4 Lookout Responsibilities.....	23
Figure 3.5 Two-Ship Line Abreast .....	25
Figure 3.6 Two-Ship Wedge.....	26
Figure 3.7 Fighting Wing.....	27
Figure 3.8 Four Ship Offset Box.....	28
Figure 3.9 Arrowhead Formation .....	28
Figure 3.10 Four Ship Wedge Formation.....	29
Figure 3.11 Fluid Four Formation .....	30
Figure 3.12 Spread Four Formation.....	31
Figure 3.13 Three Ship Vic .....	31
Figure 3.14 Delayed 90° and Hook Turns .....	34
Figure 3.15 Delayed 45°/Crossturn/Check Turns .....	34
Figure 3.16 Radio Silent Turns Into Wingman .....	35
Figure 3.17 Radio Silent Turns Away From Wingman .....	35
Figure 4.1 Angular Relationships .....	39
Figure 4.2 Attack Pursuit Courses .....	40
Figure 4.3 Insufficient Turn Rate To Maintain Lead (Resulting in Lag) .....	40
Figure 4.4 Out-of-plane Maneuvering .....	41
Figure 4.5 Outside/Inside The Turn Circle .....	42
Figure 4.6 Lag Pursuit Outside/Inside the Turn Circle.....	43
Figure 4.7 Fishhook Turn.....	44
Figure 4.8 Recognizing Turn Circle .....	45
Figure 4.9 Turn Rate and Velocity .....	46
Figure 4.10 Overshoot/Reversal Situation.....	47
Figure 4.11 Turning on Offset Turn Circles .....	48
Figure 4.12 Lag to Entry Window .....	49
Figure 4.13 Turning at Different Rates.....	50
Figure 4.14 Missile LOS Rates.....	51
Figure 4.15 Vertical Turning.....	52
Figure 4.16 Vertical Overshoot .....	53
Figure 4.17 Vertical Versus Oblique Turning.....	53
Figure 4.18 Effect of Bank Angle on Separation.....	54
Figure 4.19 Lead Turn .....	55
Figure 4.20 Lead Turn to Weapons Parameters .....	56
Figure 4.21 Lead Turn Without Turning Room .....	57
Figure 4.22 Turning Away to Defeat Lead Turn .....	57

Figure 4.23 Use of Vertical to Defeat Lead Turn .....	58
Figure 4.24 Denying Lead Turn Versus Inferior Performer.....	59
Figure 4.25 Denying the Lead Turn Versus Superior Performer .....	60
Figure 4.26 Outside the Turn Circle .....	61
Figure 4.27 Turn Circle Entry .....	63
Figure 4.28 Check and Extend .....	64
Figure 4.29 Continuous Turn .....	65
Figure 4.30 Vertical Fight Entry .....	66
Figure 4.31 Closing for Guns .....	66
Figure 4.32 Bid to Lag .....	67
Figure 4.33 Bandit Reversals.....	68
Figure 4.34 Forcing the Bandit Forward.....	69
Figure 4.35 Bandit Maneuvering Out-of-Plane .....	71
Figure 4.36 Separating Bandit.....	72
Figure 4.37 Bandit Bid to Lag.....	72
Figure 4.38 Bandit Planform Views .....	73
Figure 4.39 Continuous Turn Defense .....	74
Figure 4.40 Guns Defense .....	75
Figure 4.41 Guns Jink.....	75
Figure 4.42 One Circle—Turn Rate/Radius Advantage .....	78
Figure 4.43 One Circle—Turn Rate Advantage.....	79
Figure 4.44 Two Circle—Turn Rate/Radius Advantage.....	80
Figure 4.45 Two Circle—Sustained Turn Rate Advantage. (Energy advantage at this pass) .....	81
Figure 4.46 Off-Boresight Capable Adversary .....	82
Figure 4.47 Break Away.....	87
Figure 4.48 Break Into (Turn Into).....	88
Figure 4.49 Break Into (Turn Away) .....	88
Figure 4.50 Straight Ahead Extension.....	89
Figure 4.51 Co-Flow Entry.....	91
Figure 4.52 Counter-Flow Entry.....	92
Figure 4.53 Role Exchange .....	93
Figure 4.54 Sandwich .....	97
Figure 4.55 Early Switch.....	98
Figure 4.56 Late Switch .....	98
Figure 4.57 Uncommitted Bandit .....	99
Figure 4.58 Break in Same Direction .....	100
Figure 4.59 Cross-Turn/Hard-to-Six.....	101
Figure 4.60 Cross-turn—Bandit Approaching/At Turn Circle .....	102
Figure 4.61 Bandit Asymmetrically Positioned (Cross-Court).....	102
Figure 4.62 Break in Same Direction (Asymmetric Bandit).....	103
Figure 4.63 Cross-turn/Hard-to-six (Asymmetric Bandit).....	104
Figure 4.64 Intercept Basics .....	105
Figure 4.65 CATA .....	107
Figure 4.66 Cues for Offset Turn.....	108
Figure 4.67 Level I Pipper.....	111
Figure 4.68 Level II Pipper.....	112
Figure 4.69 Level III Pipper .....	113
Figure 4.70 Level IV Pipper.....	114
Figure 4.71 Level V Pipper .....	115
Figure 4.72 Lateral Error—Aspect and TOF .....	117
Figure 4.73 Use of 1 G Pipper Against Maneuvering Targets .....	118
Figure 5.1 Fuze Arm Warning .....	121
Figure 5.2 Fuze Categories.....	122
Figure 5.3 CCIP.....	129

Figure 5.4	Delayed Release .....	130
Figure 5.5	Postdesignate DTOS Symbology.....	131
Figure 5.6	DTOS Release .....	132
Figure 5.7	Slew Aiming .....	133
Figure 5.8	DTOS Error Correction.....	134
Figure 5.9	Base Leg Position.....	136
Figure 5.10	Low Angle Crab Correction.....	137
Figure 5.11	High Angle Drift .....	138
Figure 5.12	Effect of Dive Angle on Bomb Impact .....	142
Figure 5.13	Effect of Airspeed on Bomb Impact .....	143
Figure 5.14	Effect of Improper G Force on Bomb Impact .....	144
Figure 5.15	Effect of Release Altitude on Bomb Impact.....	145
Figure 5.16	Effect of Bank Error on Bomb Impact.....	145
Figure 5.17	Computed Strafe Symbology.....	148
Figure 5.18	CCIP Strafe with Crosswinds .....	149
Figure 5.19	HUD Symbology.....	151
Figure 5.20	LADD/Loft Profiles .....	158
Figure 5.21	TD Box Three Axis Graph .....	160
Figure 5.22	TD Box Error Example .....	160
Figure 5.23	System Altitude—Low .....	161
Figure 5.24	System Altitude—High.....	161
Figure 5.25	Blind Delivery—High System Altitude.....	162
Figure 5.26	Blind Delivery—Low System Altitude.....	162
Figure 5.27	Visual Delivery—High System Altitude .....	163
Figure 5.28	Visual Delivery—Low System Altitude .....	163
Figure 5.29	Known System Altitude Error.....	164
Figure 5.30	Conventional Range Pattern .....	165
Figure 5.31	Curvilinear Pattern .....	168
Figure 5.32	Curvilinear Pattern (Continuous Turn).....	169
Figure 5.33	Typical Pop Pattern .....	170
Figure 5.34	Pop-Up Definitions.....	173
Figure 5.35	Offset Pop-Up Profile .....	175
Figure 5.36	IP Direct to PUP.....	177
Figure 5.37	IP Direct to Target.....	177
Figure 5.38	Simultaneous Attacks .....	178
Figure 5.39	Attack Profile Sketch.....	181
Figure 5.40	VRP/VIP .....	182
Figure 5.41	Outside Pop-Up Parameters .....	183
Figure 5.42	Inside Pop-Up Parameters .....	184
Figure 5.43	Intercepting the Run-In Line .....	185
Figure 5.44	Track Point Inside MAP.....	185
Figure 5.45	Pop-Up Computations .....	186
Figure 5.46	Offset Angle Changing.....	188
Figure 5.47	Offset Turn at Constant Distance.....	189
Figure 5.48	Completed Attack Computations .....	189
Figure 5.49	Template Construction .....	190
Figure 5.50	Attack Example.....	191
Figure 5.51	2-Ship Split Pop Attack, Altitude Deconfliction.....	193
Figure 5.52	2-Ship Split Pop Attack, Distance Deconfliction.....	194
Figure 5.53	2-Ship Split Pop Attack, Time Deconfliction .....	195
Figure 5.54	2-Ship Echelon Attack, Altitude Deconfliction .....	196
Figure 5.55	2-Ship Echelon Attack, Time Deconfliction.....	197
Figure 5.56	2-Ship Echelon Attack, Distance Deconfliction .....	198
Figure 5.57	90/90 Maneuver .....	199

Figure 5.58 2-Ship Trail Attack .....	199
Figure 5.59 Simultaneous Loft .....	202
Figure 6.1 Point Parallel and Fighter Turn-On Rendezvous.....	210
Figure 6.2 Target Progression During Rejoin .....	211
Figure 6.3 Boom Envelope and Director Lights (KC-135).....	212
Figure 6.4 Boom and Director Lights (KC-10) .....	213
Figure 7.1 Arc to Start Point .....	218
Figure 7.2 50% Rule .....	220
Figure 7.3 10° Rule Example .....	220
Figure 7.4 Perpendicular Ridge Crossing .....	221
Figure 7.5 Parallel Ridge Crossing.....	222
Figure 7.6 Saddle Ridge Crossing .....	222
Figure 8.1 Typical Night Ground Illumination – 1 .....	229
Figure 8.2 Typical Night Ground Illumination – 2 .....	230
Figure 8.3 Typical Night Ground Illumination – 3 .....	230
Figure 9.1 Unload Maneuver.....	240
Figure 9.2 Nose High Recovery Maneuver.....	241
Figure 9.3 Horn Demonstration Maneuver .....	242
Figure 9.4 Horn Recovery Maneuver, 50° - 70°.....	243
Figure 9.5 Horn Recovery Maneuver, 70° - 110°.....	244
Figure 9.6 Loop/Immelmann.....	245
Figure 9.7 Split S.....	246
Figure 9.8 Cloverleaf.....	246
Figure 9.9 Pitchback .....	247
Figure 9.10 Sliceback.....	247
Figure 9.11 Reversals/Rolling Maneuvers .....	248
Figure 9.12 Vertical Recovery .....	249
Figure 9.13 Basic Tracking Exercise .....	251
Figure 9.14 Cine Track Exercise .....	252
Figure 9.15 Roll-Slide Attacks .....	253
Figure 9.16 Snapshot Exercise .....	254
Figure 9.17 Heat to Guns (Belly/Guns).....	255
Figure 9.18 Vertical Roll to Six.....	256
Figure 9.19 Cross Turn Exercise .....	257
Figure 9.20 High Aspect Gun Exercise.....	258
Figure 10.1 Stick Chart Example .....	267
Figure 10.2 TGP/LGB Loft .....	277
Figure 10.3 TGP/LGB Fly-Up Attack.....	278
Figure 10.4 NVP Direct attack .....	279
Figure 10.5 Egress Formation Flow.....	281
Table 4.1 Range Error Miss Distance (700' vs 1500' Range).....	117
Table 5.1 Weapons by Fuze Category .....	122
Table 5.2 Conventional Error Analysis Comparison.....	140
Table 5.3 Maximum Bomb Fragment Travel.....	180
Table 9.1 Time to Impact (Seconds) Wings Level Descent .....	259
Table 9.2 Time to Impact (Seconds) in Overbanked Turns .....	259

---

## Chapter One

### INTRODUCTION

#### 1.1. Overview

Fighting in the air-to-air and air-to-surface environment is a relatively new form of combat, spanning a period of only 70 years. During that time, rapid technological development has spurred progress from very primitive weapon systems to the present beyond visual range and "point and shoot" capabilities of modern fighters. Nevertheless, the very basic principles of aerial combat have remained virtually unchanged, seasoned only by actual combat and training experiences. These fundamentals, or standards, are only part of training for combat, but a very important part. The discussions on formation flying, basic air-to-air employment, and basic air-to-surface employment of the F-16 are designed to aid in building a strong foundation of tactical skills. The maneuvers addressed are a means to an end, a learning vehicle for pilots to experience first hand the methods used to achieve desired results in air combat training and surface attack tactics.

#### 1.2. Purpose

This manual is designed to supplement training programs; and when used in conjunction with MCM 3-1, provides pilots the information needed to make the right decisions during any phase of a tactical mission. This manual provides no authority or sanctions to depart from established training procedures and directives, nor is it directive in nature.

#### 1.3. Change Procedures

Aircraft modification and operational/training experience will, and should, dictate changes to this text. Old procedures and tactics should never be disregarded simply because they have been around for a while. However, new and better ways of accomplishing the mission will evolve and will need to be incorporated into this document. Safety-of-flight changes will be incorporated as soon as possible. Other inputs will be included during the normal review conference cycle. Suggested changes should be forwarded from any level of command using AF Form 847, Recommendation for Change of Publication. Send AF Form 847 to: HQ ACC/DOTF-16, 205 Dodd Blvd. Ste 101, Langley AFB, Virginia 23665-2789.

---

## Chapter Two

### PREPARATION

#### 2.1. Introduction

Mission preparation is the foundation of successful fighter operations. It encompasses psychological considerations, physical fitness, objective application, the prioritization/situation awareness relationship, and flight leadership. Each factor is part of a professional, disciplined attitude which enhances safety consciousness and increases tactical potential.

#### 2.2. Establishing Priorities

It is an acknowledged fact that during the heat of any mission, there are occasions when you can't do everything in the time available. This requires assigning priorities (task prioritization). At the top of the list are things you have to do—do them first. Lower on the list are things you'd like to do—do them later when they don't interfere with the have-to-do things. Your list of have-to-do tasks should be established long before you get near an airplane. Some basic top priority tasks are:

- Maintain aircraft control.
- Never hit the ground (or anything attached to it).
- Never hit anything in the air (i.e., your lead/wingman).
- Never run out of fuel.
- Never let anything shot from the ground or air hit your airplane.



### **2.3. Prioritizing Tasks**

Lower priority tasks range from answering fuel checks on the radio to calling METRO with a PIREP. There may be some shifts in your high priority items, but they never go away completely. For example, at 20,000' in close formation in the weather, avoiding collision with members of your flight is a bigger concern than hitting the ground. Obviously, mission accomplishment has a high priority, but remember, if you don't get yourself and your airplane home, you've failed to accomplish a major part of the mission. In peacetime, there is no mission more important than safe recovery of your airplane. If you let nice-to-do things take priority over have-to-do things, you are guilty of misprioritization and you jeopardize yourself and those around you. Many of the revisions in this manual are the result of accidents that occurred because of misprioritization. If the rare occasion comes up where aircraft malfunction/emergencies make it impossible for you to perform your top priority tasks, it may be time to eject.

### **2.4. Psychological Considerations**

Fighter missions demand total involvement, whether it be actual combat or continuation training. This requires mental preparation prior to every mission. Mental preparation requires setting aside outside stresses, allowing for total concentration on the mission. Habit patterns cannot be turned on and off at will. The same skills and techniques developed during continuation training will be the ones used in combat. Professionalism and discipline are qualities common to all fighter pilots and the basis for the fighter pilot attitude. This ensures a proper blend of pride, desire, aggressiveness, and knowledge.

### **2.5. Physiological Considerations**

We have reached the stage where USAF fighter aircraft can exceed pilot tolerance for sustained high G's. This capability often allows pilots to apply more G's than their body can tolerate; after a "short grace period," oxygen available to the brain is depleted and consciousness is lost. Pilots must anticipate G-onset, control the G-onset rate, and coordinate their G-straining maneuver. This requires mental discipline and practice to master. Failure to do so could spell disaster. G-induced loss of consciousness (GLOC) has two serious traits. First, it is more dangerous than other pilot stresses because it is not possible for the pilot to accurately and reliably know how close he is to the GLOC threshold. Secondly, since amnesia (of the incident) is a characteristic of GLOC, the pilot may never know that he has ever lost consciousness and may not be cognizant of any "close calls" he's lucky enough to have survived. The best solution to the GLOC problem is keyed to pilot awareness. The pilot has ultimate control over G-stress factors. Here are some factors to consider:

#### **2.5.1. Flight Factors**

High onset rates and long periods of sustained high-G seem to bring the pilot's body to the brink of exhaustion more quickly than at lower G-levels. High onset rates can bypass the normal stages of reduced vision resulting in near-instant unconsciousness.

#### **2.5.2. Diet, Conditioning, And Rest**

The result of good diet, proper physical conditioning, and adequate rest is a fighter pilot who is mentally and physically prepared to meet demanding mission tasks. The lack of respect for any one of these factors could be fatal in a high-G environment. There is also a synergistic effect when more than one of these factors is below standard. Be prepared, mentally and physically, for high-G stress. Proper physical conditioning involving anaerobic training (free weights, Nautilus, Universal Gym, Hydra-Fitness, etc.) and aerobic training (running, racquetball, cycling, etc.) play an important role in improved G-tolerance. Proper mission planning begins with good physical and mental preparedness.

#### **2.5.3. Currency, Anxiety, & Aggressiveness**

G-tolerance is increased through practice. Layoffs such as a long leave, DNIF, or even just coming out of a low-G flying phase require a build-up of G-tolerance. Anxiety in new situations or other pressures can mask your objectivity in assessing your tolerance. Aggressiveness, if not properly controlled, can lead to overconfidence and inattention to, or disregard for, bodily warning signs of fatigue and stress. Pilots need to be aware of these factors and be on guard for signs of G-stress limits. An individual's G-tolerance and warning signs can vary significantly from day-to-day. Fatigue, tunnel vision, or gray-out are critical

warning signs that the pilot is already at his limit. Do not attempt to maneuver your aircraft up to these limits; there is no buffer/reliable safety margin. Expect your G-tolerance to vary at different times even on the same flight, based on all the factors discussed above. When a pilot suspects his effectiveness is being reduced, he must take appropriate action. In combat, it may mean separation if able; in training, it means a knock-it-off and a less demanding alternate mission. Here are guidelines to follow:

- Identify high-G situations and maneuvers in the briefing for each mission and the proper techniques for avoiding GLOC.
- If you haven't flown high-G sorties recently, tailor the mission accordingly.
- Don't forget proper G-suit fit and straining maneuver techniques. By far the most important factor in improving G-tolerance is the performance of a good, well-timed, and coordinated G-straining maneuver.
- Perform a good G-awareness exercise.
- Anticipate the onset of G. **Strain early.**
- Make G-awareness part of your situation awareness in flight. Avoid "snatch pulls" to high-G. Make all G-inputs smooth, with controlled buildup, and within your personal limits.
- Exercise strong flight lead control and consider coming home early if any flight member feels fatigued.
- Although Combat Edge-equipped aircraft decrease the effects of G-fatigue, you must not become complacent. You still need to perform a correct G-straining maneuver.

Don't sacrifice good training, but do be sensitive to the dangers of GLOC through all engagements. Loss of consciousness is a serious problem, but it can be controlled. You and your approach to the entire problem are the keys to its solution. Take GLOC seriously; the consequences can be fatal. **You** will make the difference. For a more comprehensive review of G-stress factors and GLOC, refer to AFPam 11-404, *G-Awareness for Aircrew*.

## 2.6. Mission Objectives

Preparation for any given mission is based on mission objectives tailored to the lowest common denominator. The objectives are performance standards to measure individual and team success during any mission, and should give the "big picture" of what's happening. A valid objective has three parts: performance, conditions, and standards.

### 2.6.1. Performance

This is what each pilot or the flight is required to do during the mission. It describes action and is not vague. Use action verbs such as: demonstrate, employ, or practice.

### 2.6.2. Conditions

This is where it's happening, the environment. Examples include line abreast formation or outside the bandit's turn circle.

### 2.6.3. Standards

These state how well the performance must be done and are categorized by time limits, accuracy, and/or quality. Time-on-target (TOT) within plus or minus 30 seconds, hits within 10 meters, or ranging within plus or minus 500' are examples.

### 2.6.4. Planning Considerations

Defining objectives also depends on contingencies and other planning considerations: weather, sun angles, day or night, the threat, or the frag order are a few. Incorporating well defined objectives based on the mission requirements and the particular mission's lowest common denominator (e.g., weather, wingman experience) pays benefits in terms of combating misprioritization and increasing situation awareness.

## **2.7. Misprioritization**

Misprioritization can have disastrous results. By professionally preparing for each mission and defining objectives incorporating the lowest common denominator, we can delay or deny task saturation factors. Each member of the team must mentally fly the mission before he straps on his jet (chair fly). Search for situations that are most critical and mentally address what would happen in your cockpit: instrument cross-check, change switches, check your six, check your mates' six, check gas, or practice a critical emergency. Stress basic situation awareness. Fighter pilots aren't born with it; SA must be developed and kept "current." Mentally engaging a MiG simply isn't enough. "Look" at the fuel gauge and comprehend what it tells you: "joker fuel = snap-shot, separate, expend flares (channelize the MiG driver's attention), run, where's lead?" Get the "big picture"; strive for "no surprises."

## **2.8. Situation Awareness**

The cornerstone to formation success is situational awareness (SA). SA is your perception and understanding of what is actually occurring in the aerial arena. It is gained through assimilating information obtained through:

- On board radar.
- RWR.
- Flight members.
- GCI/AWACS.
- Support assets.
- Visual acquisition.
- Mutual support.

## **2.9. Flight Leadership**

Flight leaders have the general responsibility for planning and organizing the mission, leading the flight, delegating tasks within the flight, and ensuring mission accomplishment. They are in charge of the resources entrusted to them. They must know the capabilities and limitations of each flight member. Once airborne, they have the final responsibility and controlling authority for establishing the formation(s), maximizing the flight's effectiveness, and leading the flight successfully to and from the target.

## **2.10. Wingman Responsibilities**

Wingmen also have critical responsibilities in the flight. They help the leader plan and organize the mission. They have visual lookout and radar responsibilities, perform back-up navigation tasks, and are essential to target destruction objectives. Wingmen engage as briefed or when directed by the leader and support when the leader engages. It is essential wingmen understand their briefed responsibilities and execute their contract with discipline.

Discipline is the most important quality a fighter pilot can possess and leads to success in the aerial arena. Discipline is executing self-control, maturity, and judgment in a high-stress, emotionally charged environment. Teamwork is the foundation of the fighting element. If all flight members know and perform their respective duties, they work together as a team. Experience and realistic training leads to solid and professional air discipline.

## **2.11. Mission Preparation**

Whether a basic student upgrade sortie or a complex combat mission, successful accomplishment demands thorough preparation. This mission preparation consists of two phases, mission planning and mission briefing. Incomplete preparation in either area degrades mission accomplishment.

### **2.11.1. Mission Planning**

The flight leader establishes priorities for mission planning and delegates them to flight members to ensure all planning considerations are addressed while precluding any duplication of effort. The air-to-air and air-to-surface chapters of this volume contain additional information specific to these roles. The

depth of planning detail is dictated by the mission and flight experience level, but the bottom line is: all necessary mission planning is completed in time to conduct a concise, comprehensive briefing.

The two main factors which determine the direction of mission preparation are the role of the F-16 for the particular mission (offensive counter air, interdiction, combat air patrol, etc.) and the overall mission objective (student training syllabus objectives, continuation training profile, visual bombing qualification, target destruction, etc.).

Additional factors, determined by the role and overall objective, which must be addressed during mission preparation include:

- Flight composition.
  - Size.
  - Experience level of flight members.
- Higher headquarters (HHQ) guidance.
  - Syllabus.
  - MCI 11-F-16 Vol 1 & 3.
  - Air tasking order (ATO) (frag).
  - Rules of engagement (ROE).
  - Special instructions (SPINS).
- Support forces.
  - Controlling agencies.
  - Communications.
  - Fuel considerations/refueling.
  - Escort, SEAD, ECM support.
- Routing.
- Threats.
  - Cockpit indications.
  - Capabilities.
  - Numbers and locations.
  - EID requirements.
  - VID requirements.
- Weather.
- Aircraft configuration.
- Fuel tanks.
- Low altitude navigation and targeting infrared for night (LANTIRN) pods.
- Weapons loads.
- ECM pod.
- Self protection missiles.
- Weapons delivery options.
- Egress and safe passage procedures.
- Contingencies.

#### 2.11.2. **Mission Briefing**

The briefing sets the tone for the entire mission. Establish goals and have a plan to achieve them. Write the mission objectives on the board and establish a standard which measures successful performance.

Standard briefing items to include start, taxi, takeoff, recovery, and relevant special subjects should be covered in an efficient manner. Elements of the mission which are standard should be briefed as "standard." Spend most of the time describing the "what" and "how to" of the mission.

If adversaries, friendly players, intelligence (Intel), or other mission support personnel are present, brief them first on only pertinent information and the mission. Ground controlled intercept/airborne warning and control system (GCI/AWACS) controllers, however, should receive the entire tactical briefing and must fully understand the gameplan to include ROE review, ID procedures, and the comm plan. Alternate missions are less complex but also have specific objectives.

The flight lead must be dynamic, credible, and enthusiastic. He motivates and challenges the flight to perform to planned expectations, asking questions to involve flight members and determine briefing effectiveness.

### **2.12. Debriefing**

The objective of the debrief is to determine if the desired mission objectives were achieved, identify lessons learned, and define aspects of training needing improvement.

Reconstruction of the mission objectives occupies most of the debriefing. Before the debriefing, use everything available, such as the video tape recorder (VTR), notes, range scores, and air combat maneuvering instrumentation (ACMI), to reconstruct the mission and evaluate its success. If telephonically debriefing adversaries, have a gameplan to include a debrief time. Preparation before beginning debrief with flight members and adversaries provides a well-controlled, effective debriefing. An honest assessment of accomplishments is more important than "winning the debrief."

Get the small items out of the way first. Discuss significant departures from the briefed flow or established procedures without belaboring the items. Review the mission objectives and provide a general impression of mission success. It is essential to derive accurate lessons learned; not simply the mistakes made.

Some missions do not lend themselves to detailed reconstruction. Choose only the significant events that impact the objectives of the ride. The final summary includes an assessment of strong and weak points and the required corrections.

---

## **Chapter Three**

### **FORMATION**

### **3.1. Basic Formation**

Formation discipline is essential for the safety and control of all formation flights. The integrity of a formation can only be maintained when the leader has complete knowledge and control of the actions of each flight member. The flight leader will brief the formations to be flown and formation responsibilities. Wingmen will maintain assigned formation position until change is ordered or approved by the flight lead.

#### **3.1.1. Radio Discipline And Visual Signals**

Discipline within a formation starts with communications, whether by radio or visual signals. All communications must be clearly understood by every flight member. Radio discipline requires not only clarity and brevity in the message itself, but limiting unnecessary transmissions as well. The first part of any radio call should always be "call sign." This alerts the listener that a message is coming (attention step) and to specify to whom it is directed. The use of tactical or personal call signs or reliance on voice recognition or tone/inflection to identify another aircraft are poor practices, intolerable in combat. For an acknowledgment immediately following a radio call from lead, flight number (i.e., 2, 3, 4) with the appropriate response will be used. For all initiated calls or a response that is delayed, full call sign must be used. In exercise or actual combat with many aircraft and many people on the radio, proper use of assigned call signs and MCM 3-1, Volume 1, brevity words enhance situational awareness between and within flights; poor radio discipline will quickly degrade situational awareness with invariably disastrous results. In the event that a tasking agency gives you a cumbersome mission number to use as your call

sign, resolve the problem during preflight planning. *EXAMPLE:* "Viper 21, group, 210°, 25 miles, 30,000', head." Acknowledgment—"Two same." Delayed acknowledgment—"Viper 22 same." Limit radio use (UHF, VHF, or FM) to essential calls only. Use visual signals from AFI 11-205 whenever practical. Only standard signals should be used unless the flight leader specifically briefs non-standard signals.

Ops checks will be initiated by the flight leader. This is the time to confirm proper fuel state, fuel transfer, engine operation, and operation of life support equipment. It is each pilot's responsibility to continually check these items without prompting by the flight leader.

### 3.1.2. Ground Operations

Prior to stepping, the flight lead should confirm configuration to ensure the aircraft/pilot combination are optimized. Fuel tank and weapons configurations are two of the most obvious factors to be considered. Each pilot should make a quick study of the aircraft historical data for any system peculiarities. Before takeoff, a thorough check of all aircraft systems should be completed and the flight lead informed of any problems. Also, ensure that your rudder trim is centered. Minimum systems checked should include:

- VTR—tape titled.
- INS—VVI and drift/GS.
- SMS weapon load/operation.
- RWR.
- Chaff/Flares. Programmer set.
- ECM pod(s) (if loaded).
- Radar.
- BIT check.
- Channels, subsets, frequency agility set.
- MFD set-up.
- HUD.
- Master arm switch.

### 3.1.3. Formation Takeoff

The leader will direct the appropriate runway line-up based on winds and runway width. Wingmen should line up ensuring wingtip clearance (runway width permitting) and just slightly forward of the normal in-flight reference (line up the main landing gear wheels). If in a four-ship echelon line-up, numbers three and four should align helmets of preceding flight members. If in a three/four-in-the-slot line-up, two should line-up in echelon but with sufficient wingtip spacing to allow three/four to establish position without his wingtips being in one's or two's exhaust. Three/four should line-up in echelon with four lining-up where he can see his element mate's cockpit in front of two's vertical stabilizer. On the leader's signal, the throttle is advanced. The signal for brake release is a head nod or radio call. The leader will make a normal takeoff except that after he advances the power to MIL or MAX, he will retard it slightly to allow the wingman a power advantage.

At the leader's signal, the wingman will go to full MIL or MAX and stabilize with wingtip clearance. If you initially get the jump on lead, reduce power slightly to maintain position. The best technique is to concentrate on flying formation from brake release, then match lead's rotation rate. When safely airborne, the leader will pass a gear up and AB out signal, if appropriate. If the gear signal is missed, raise your gear when the leader's gear starts to move. Glance in quickly to ascertain your gear is up and locked. Move smoothly into fingertip while checking lead's aircraft from front to back to detect open panels, open gear doors, fuel/hydraulic leaks, etc.

The wingman will maintain wingtip clearance throughout the takeoff roll. If overrunning the leader, you will be directed to assume the lead while continuing the takeoff. If either member of the element must abort, the other member should continue the takeoff. In either case, directional control (staying on your side of the runway) is essential to prevent collision.

### 3.1.4. Trail Departure

A trail departure is normally used to get a flight of two or more airborne when conditions won't permit a formation takeoff or rejoin out of traffic. Wet runways, crosswind limits, weapons loads, configuration differences, and low ceilings or poor visibility are normally deciding factors. Trail departure procedures will be IAW AFI 11-F16 Vol 2, unless briefed otherwise by the flight leader.

Prior to takeoff, the departure plate should be reviewed and all navigation equipment set up properly. Listen carefully to the clearance and controlling agencies for nonstandard or unpublished restrictions. Set up the radar for easy acquisition. As a technique, select:

Range-while-search (RWS) in the F-16C or normal air mode (NAM) in the F-16A. This allows you to observe all returns and verify which are flight members. The air combat mode (ACM) is not normally desired because search patterns are smaller than those available in NAM or RWS, and you get an automatic lock without the opportunity to analyze contacts. You normally should use this mode only when you can visually verify you have locked the correct aircraft. Track-while-scan (TWS) in the F-16C also has limitations. The search pattern is smaller, and if the cursors aren't in the proper position, the azimuth scan pattern may be incorrect. If the AUTO submode is selected and the pilot has not stepped the bug, the system may determine the highest priority target is a non-flight member. This could result in the azimuth and/or elevation scan being biased away from flight members and loss of contact. TWS extrapolation could provide erroneous data; especially during a turn.

- 10 NM range (20 NM required for multi-ship or element departure spacing).
- + 60° azimuth sweep (consider + 30° for a faster sweep pattern if the departure is straight ahead).
- Four bar scan and rotate the ANT ELEV knob slightly above the detent.

Select MTR HI (F-16C) if departing from an airfield where there are numerous fast moving ground returns. This should eliminate many false targets and make it easier to ascertain flight members. If ground clutter is not a problem, then MTR LO (F-16C) may be preferable to paint slow movers. In the F-16A, high notch cannot be selected until airborne, but is then an option if ground clutter is a problem.

- Target history 2 or 3.
- MED PRF (F-16A).
- Channel, subset, and frequency agility band as briefed.

During takeoff, maintain aircraft control by making a timely transition to instruments as outside visual cues deteriorate. Your overriding priority must be flying the aircraft, not operating the radar. Get the aircraft safely airborne, gear retracted, and establish a safe climb at departure airspeed. If there is a turn or intermediate level-off shortly after takeoff, ignore the radar until you have completed these tasks.

Aircraft with enhanced HUD symbology incorporating "HUD nuggets" are authorized to use the HUD as a Primary Flight Reference (PFR) in accordance with AFM 11-217 (replaced 51-37) and Tech Order guidance. However, use caution during all phases of flight in order to avoid the tendency to channelize your attention in the HUD. Do not maintain radar trail through sole use of the HUD and be particularly cautious during the subsequent rejoin. Always backup your crosscheck through the use of your heads down displays (HDD).

During climbout, establish and maintain briefed power setting (FTIT: PW—850°, GE—750°/725°) and airspeed. **Fly the instrument departure** using control and performance instruments in a composite cross-check. Listen to the radio for instructions and information. Unless restricted by a SID or controller instructions, begin all climbs at the same time as the leader (usually when lead acknowledges the altitude change). Lead should call passing every 5000' increment until all flight members are tied/visual. If you fly the departure using briefed headings, altitudes, bank angles, airspeeds, power settings, and radio calls, you will not run into your leader or preceding aircraft. As a rule of thumb for turns using 30° of bank, allow the preceding aircraft to drift 5° laterally for each mile of separation between aircraft. For example, to maintain a 2 NM trail position, allow the preceding aircraft to drift 10° before initiating your turn; to maintain a 3 NM trail position, allow him to drift 15° before starting your turn. If spacing is greater than desired, initiate the turn prior to the standard lead point to establish cutoff and decrease separation. One technique is to keep the target at 0° azimuth during a turn. This "pure pursuit" technique establishes an

easily controllable amount of cutoff. As the range decreases to the desired separation, roll out a little bank and let him drift to the appropriate azimuth to maintain that spacing. If spacing is less than briefed, allow the preceding aircraft to drift beyond the normal lead point before initiating the turn and separation will increase. As a technique, letting the target drift no more than 10° colder than the azimuth required to maintain spacing works well. Nearing the desired separation, increase your bank angle slightly to bring the target to the azimuth which will maintain that spacing.

When cockpit tasking permits, use the radar to identify preceding flight members in order to fine tune your trail position. Flying instruments and maintaining aircraft control is still the overriding priority. Do not allow your attention to be channelized on the radar. This potential trap is particularly insidious when experiencing problems gaining radar contact.

When you are ready to use the radar after takeoff, you should see lead or the preceding flight member approximately 2 miles in front of you. If you do not, place the cursors at the range and azimuth where you think he should be and check your elevation search pattern. More than one wingman has been lost while 2 miles behind and below lead due to incorrect antenna elevation positioning. Since you will be at or near the same speed of other flight members, expect their target histories to be superimposed or extremely close together. If there are numerous contacts, concentrate on those which are at a range and azimuth on the scope consistent with the departure ground track. Again, do not allow your attention to be channelized on the radar if you are having trouble gaining contact. At the first indication of task saturation or disorientation, immediately concentrate on flying instruments. Flying the aircraft is always the first priority.

Once you have radar contact, you have to decide whether to lock on or to fly a no-lock trail departure. While a no-lock departure allows you to clear your flight path, normally it is easier to maintain precise position and radar contact with a lock. As number three or four, you probably want to keep track of all preceding flight members. In this case, you may not want to take a lock or you may prefer to use TWS (F-16C). You normally will not be able to use the situation awareness mode (SAM) since the close range of flight members causes the radar to automatically transition to single target track (STT) when you lock on. If you take a lock, the preferred method is by placing the cursors over the target and designating with the target management switch (TMS). This is the best way to ensure that you have the desired aircraft locked. An unverified ACM lock could be hazardous. If, for example, you were number three and didn't realize that the ACM lock was on lead instead of number two, the result could be a mid-air collision since both you and number two would be trying to fly the same position behind lead. No matter the method, all locks should be verified by ensuring the target is at the correct range, azimuth and altitude, and is flying the proper ground track at the briefed airspeed. If there is a doubt, immediately return to a search mode to regain/ensure situation awareness.

Fly radar trail by through reference of the radar display/MFD and the HUD. While all data is available on the radar display, azimuth and range information is not as precise as that shown in the HUD. Retaining a 10 mile range scale display makes it easier to estimate the distance between flight members, but limits clearing your flight path to only 10 miles. You may wish to occasionally switch to the 20 mile range scale for this reason. In order to use the HUD, you must have a radar lock. You can then reference the TD box (or TLL) for azimuth, and the target range and closure rate displays for separation. While a printout of the target's elevation is not available in the HUD, you can compare the TD box (or TLL) elevation with your HUD altitude to get a fairly good estimate. In the F-16C, one technique is to combine use of both the HUD and radar display by selecting TWS, 20 mile range display, with the preceding flight member as the bugged target. This way you can use the radar display to clear your flight path and keep track of all preceding flight members. You can reference the HUD for more precise azimuth and range information for the aircraft you are following. The biggest limitation to this technique, however, is that it requires an extensive cross-check. Whatever method you use, primary attention should be on basic instrument flying. Use small bank changes and fly the briefed airspeed and power setting to maintain position.

After you confirm that you have the preceding flight member on radar, call "tied." Call "visual" when you see him visually. Until all flight members are tied, the flight will continue making required radio



calls. Once a tied or visual call has been made, advise the leader if either radar or visual contact is subsequently lost. When lead directs joinup, procedures are the same as in VMC.

The bottom line is to maintain aircraft control and fly the instrument departure. Watch out for task saturation, channelized attention, and disorientation. Radar work takes a back seat when prioritizing tasks. Successful trail departures have been flown for decades without the use of a radar.

#### 3.1.5. **Fingertip (Close) Formation**

Fingertip is flown in a position that aligns the front portion of the wingtip missile launcher rail (or forward missile fins) with a point halfway between the ECS duct and the leading edge of the intake fairing. Fly laterally to align the trailing edges of the exhaust nozzle.

For echelon, the relative position is the same as fingertip. Turns into the echelon will be avoided if at all possible. If a turn is made into the echelon, each aircraft will maintain the same relative position as in straight and level flight. On turns away from the echelon, all aircraft will maintain the same horizontal plane.

#### 3.1.6. **Crossunders**

When the number two aircraft is required to cross under in a flight of three or more, number three (or the element) will move out to allow number two sufficient spacing to move into position. Number two will drop below and behind the leader, maintaining nose-tail and vertical clearance, then move up into the wing position on number one. Number three will then move in on number two's wing.

When an element is required to cross under, the element will drop below and behind the lead (element) maintaining nose-tail and vertical clearance, cross to the opposite side, then move up into position. Number four changes positions during the crossunder.

#### 3.1.7. **Route Formation**

Route formation is flown as a modified fingertip formation with up to 500' between aircraft. When turned away from, the wingman will stack level with the leader. When turned into, the wingman will only stack down enough to keep lead in sight and avoid his maneuvering plane. Crossunders may be directed using a wing dip as in close formation.

For echelon, the relative position is the same as route. If a turn is made into the echelon, each aircraft will only stack down enough to keep rest of the formation in sight and avoid their maneuvering plane. Lead should avoid excessive bank angles. On turns away from the echelon, all aircraft will maintain the same horizontal plane.

#### 3.1.8. **Trail Formation**

Close trail position is defined as one to two-ship lengths behind the lead aircraft and below his jet wash.

Trail formation will be flown in a cone 30° - 60° aft of lead at a range briefed by the flight lead to accomplish specific requirements. Avoid flying at lead's high six o'clock and use caution not to lose sight of lead under the nose.

#### 3.1.9. **Show Formation**

Diamond: Wingmen fly normal fingertip formation. The slot pilot flies a close trail position maintaining nose-tail clearance. Current restrictions may not allow this formation.

Missing Man: Normal four-ship fingertip formation. On command from the leader, the number three aircraft pulls up and out of the formation. The number four aircraft holds position, maintaining relative spacing between himself and the leader.

#### 3.1.10. **Rejoin**

Any rejoin requires an accurate appraisal of position and closure. The low drag nature of the F-16 and relative ineffectiveness of small throttle changes in slowing down require some anticipation for power reduction. The speed brakes are effective in reducing overtake. A radar lock-on may be used during the rejoin to provide range and overtake information. Maintaining 50 - 100 knots of true overtake will

provide a controlled, expeditious rejoin. If you are number three or four, ensure that you are locked to the leader. As separation decreases to approximately 3000', reduce power smoothly to control overtake. At approximately 1500', true overtake should be about 50 knots. Consider using the speed brakes if overtake is excessive. Be able to stabilize momentarily 100' - 200' out in route position and then smoothly move into the fingertip position. If overtake is excessive approaching the extended fingertip position, initiate a controlled overshoot.

#### 3.1.11. **Lead Changes**

Lead changes require an unmistakable transfer of responsibilities from one flight member to another. Lead changes may be initiated and acknowledged with either a radio call or visual signal. Visual contact with the new lead is required prior to initiating a lead change. The flight member assuming lead will be no further aft than the normal route/fingertip position prior to initiating or acknowledging the lead change. The lead change is effective upon acknowledgment. All flight members must continue to ensure aircraft separation as positions are changed. The new leader must continue to monitor the new wingman's position until the leader is established in front with the wingman looking at lead. If the radio is used for the lead changes, use call signs and be specific. The wingman assuming the lead will so state in his acknowledgment. Lead changes using visual signals may be preferred since it guarantees that the flight members are looking at each other. Whether done visually or using radio calls, all flight members must monitor aircraft separation until the new positions are established.

#### 3.1.12. **Weather Formation**

Weather formation in the F-16 may require some adjustment in your formation procedures. The aircraft is very responsive to pilot inputs; therefore, a smooth, steady hand and a light grip are essential.

For leaders, when flying formation in IMC, or transitioning from VMC to IMC, monitor your attitude and altitude so as not to exceed 30° of bank or enter an excessive descent rate.

For wingmen, when flying close in turbulent conditions, do not attempt to rapidly counteract every gust with control inputs. Remember, your leader is flying in the same patch of air, and both your aircraft and his will react the same way to rough air. Use smooth corrections and avoid rapid erratic control inputs. Lost wingman procedures should be used if you lose sufficient visual formation reference.

#### 3.1.13. **Leaving Formation**

It is the duty of the wingman to leave the formation:

- When directed to do so.
- When you lose sight of the aircraft ahead.
- When you are unable to join up or to stay in formation without crossing over, under, or in front of the aircraft ahead.
- At any other time you feel that your presence in the formation constitutes a hazard.

When you leave formation, clear yourself in the direction of your turn and notify leader. If you have lost sight of the lead, comply with the appropriate lost wingman procedure.

Rejoin only when directed to do so by the flight lead.

#### 3.1.14. **Lost Wingman Procedures**

Refer to MCI 11-F16 Vol 3. Again, rejoin only when directed to do so by the flight lead.

#### 3.1.15. **NORDO/Emergencies**

Comply with briefed procedures. The flight lead will usually brief a NORDO rendezvous point and escort requirements during the mission briefing.

#### 3.1.16. **Formation Landing**

Lead Procedures:

- Establish an approach speed consistent with the heavier aircraft.
- Position the wingman on the upwind side if the crosswind component exceeds five knots.

- Plan to land near the center of your half of the runway to ensure enough runway is available for the wingman.
- Ensure touchdown of the heavier aircraft is no slower than 13° AOA.
- Do not touchdown long and fast.

#### Wing Procedures:

- Maintain a minimum of 10' lateral wingtip spacing.
- Stack level with the lead aircraft as briefed by the flight lead when you are VMC and configured on final approach.
- Cross-check the runway to ensure sufficient runway is available.
- Go-around or execute a missed approach if sufficient runway/aircraft clearance is not available.

#### Roll-out Procedures:

- Prior to aerobraking, the leader should hold landing attitude until nose-tail separation is assured.
- The wingman should smoothly aerobrake, avoiding abrupt aft stick.
- Each pilot will maintain his landing side of the runway until both have slowed to normal taxi speed.
- After assuring clearance, move to the turnoff/cold side of the runway. Wingmen may clear the leader to the cold side after their aircraft is under control.
- If the wingman overruns the leader, accept the overrun and maintain the appropriate side of the runway. Do not attempt to reposition behind the leader. The most important consideration is wingtip clearance.

### 3.2. Tactical Formation

Varying factors of the tactical arena (weather, visibility, background, terrain, threat, etc.) will determine the position and responsibilities for the individual flight members. Central to all maneuvering must be a capability to communicate intent, role, and threat information. Definitions of pilot responsibilities and emphasis on air discipline will help ensure success in a restricted communications environment. The formations described in this chapter are applicable for both air-to-air and air-to-surface operations. The guidelines given have proven to be the most universally applicable. As the tactical situation changes, the numbers given here may change. For a more detailed discussion on how and why various factors effect formation decisions refer to MCM 3-1, Volume 1 and Volume 5. Remember, flying a given formation is not an end in itself; it facilitates proper task prioritization, lookout, and offensive/defensive considerations. If you cannot perform your responsibility in a formation listed, get into one which does permit you to carry out your formation responsibilities. The flight briefing should cover, as much as possible, any changes that may be necessary.

#### 3.2.1. Mutual Support

A vital subset of situational awareness is mutual support (MS). Mutual support is a contract within a flight of two or more aircraft that supports the flight's mission objectives. An effective mutual support contract will enable a flight to maintain the offensive while enhancing its survival in a hostile environment. Mutual support in the modern combat arena is more directly related to SA than ever before. It demands position awareness of other flight members and the threat as well as an understanding of the flight's and the threat's weapons capability. Flight leads must carefully assess the experience/proficiency level of their flight members when developing the flight's MS contract. A sound MS contract should provide for:

- Position awareness of other flight members.
- Early position awareness of the threat and the attack axis.
- Communication of offensive and defensive information to the flight.
- Targeting and weapons employment prior to threat attack.
- The ability to prosecute the attack and/or disengage.

### 3.2.2. Formations

Visual formations can provide for all of the elements of a sound MS contract. Additionally, visual contact with other element members is critical in a visual fight. We typically choose to travel in a visual formation as we cannot always assume that the enemy at large is beyond visual range. Visual formations are easy to fly, provide a common and reliable reference for comm and targeting, mass firepower, and most importantly, provide immediate position awareness of supporting fighters. The angular references in Figures 3.1, 3.2, and 3.3 are valuable aids for flying effective tactical formations.

Visual lookout is a priority task for all flight members, flight leads as well as wingmen. Historically, 90% of all air-to-air kills were achieved due to undetected attacks. Visual formations evolved throughout the years in an attempt to visually clear on another and deny the enemy an unseen entry. In addition to visual detection, survivability increases when each flight member has a potential for timely assistance by using the radio or his weapons. The amount of time you spend maintaining visual contact or the formation position influences your ability to detect a threat visually or by other means (radar, GCI, etc.). In addition, the dynamics of air combat maneuvering often drive you to a position where providing timely assistance is difficult.

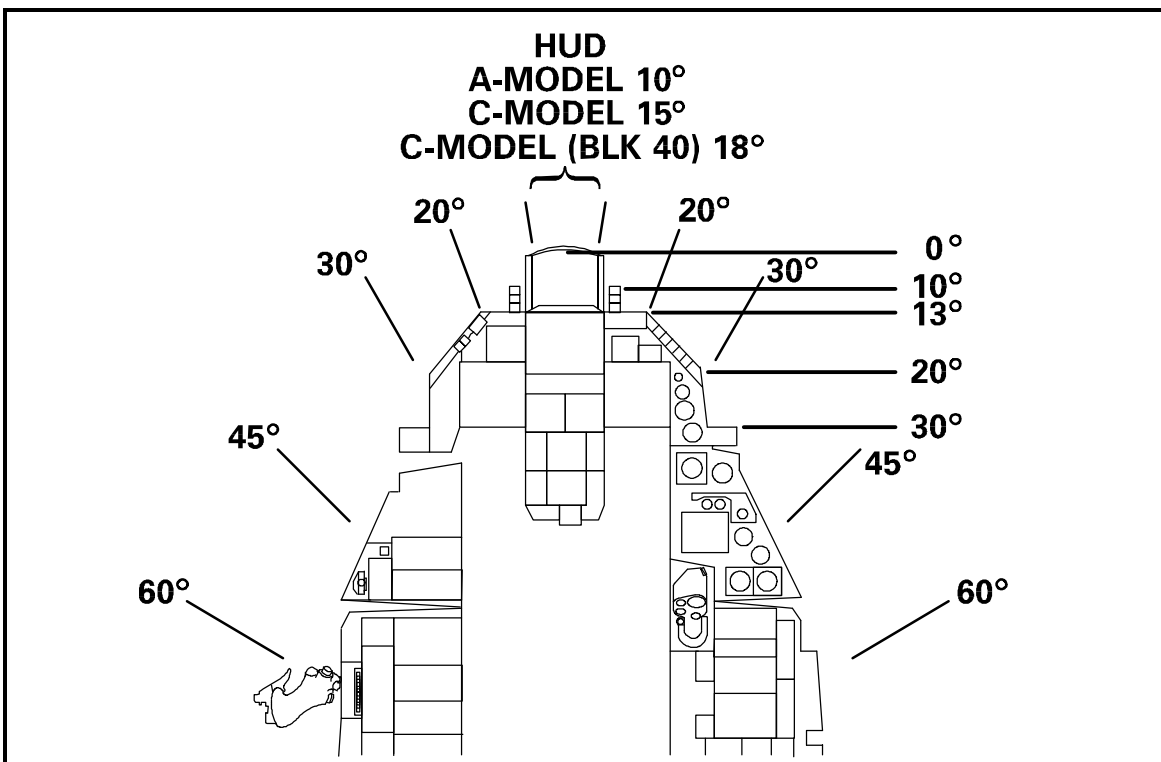


Figure 3.1 F-16 Canopy Codes

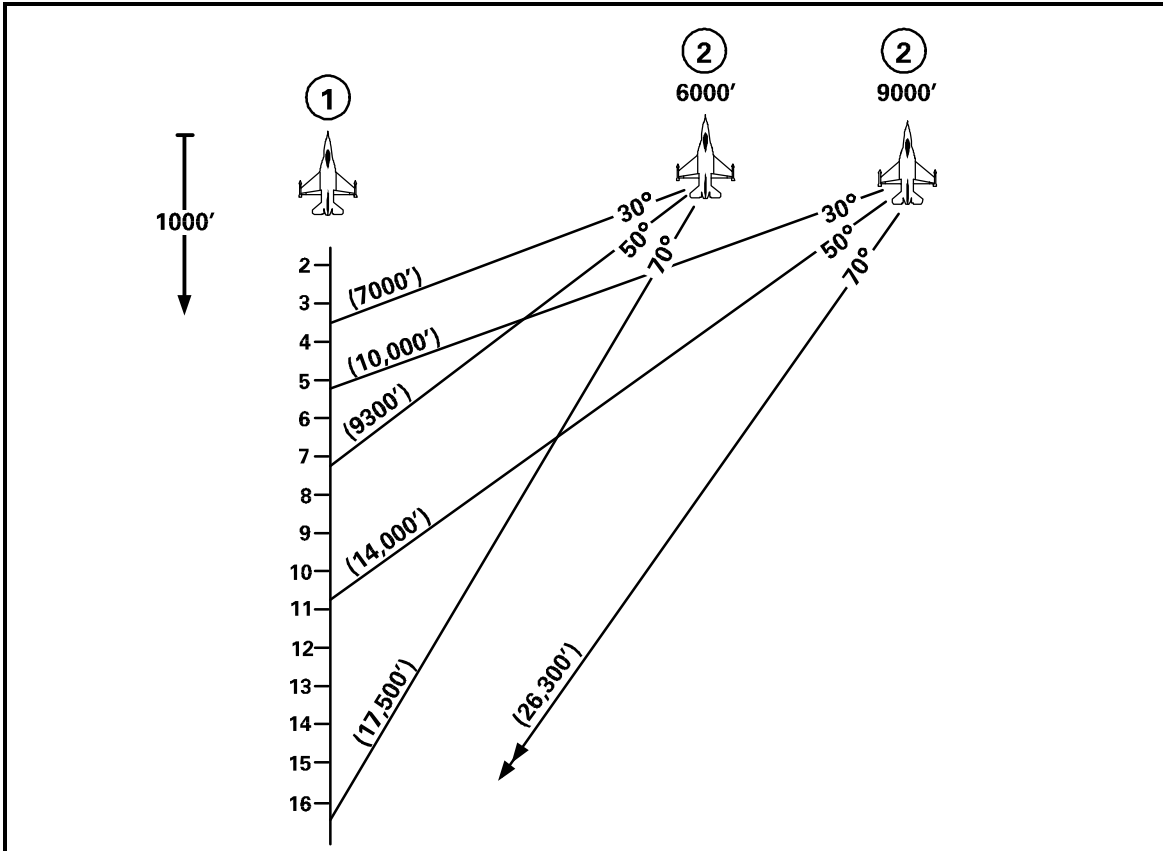


Figure 3.2 Six O'Clock Visual Coverage

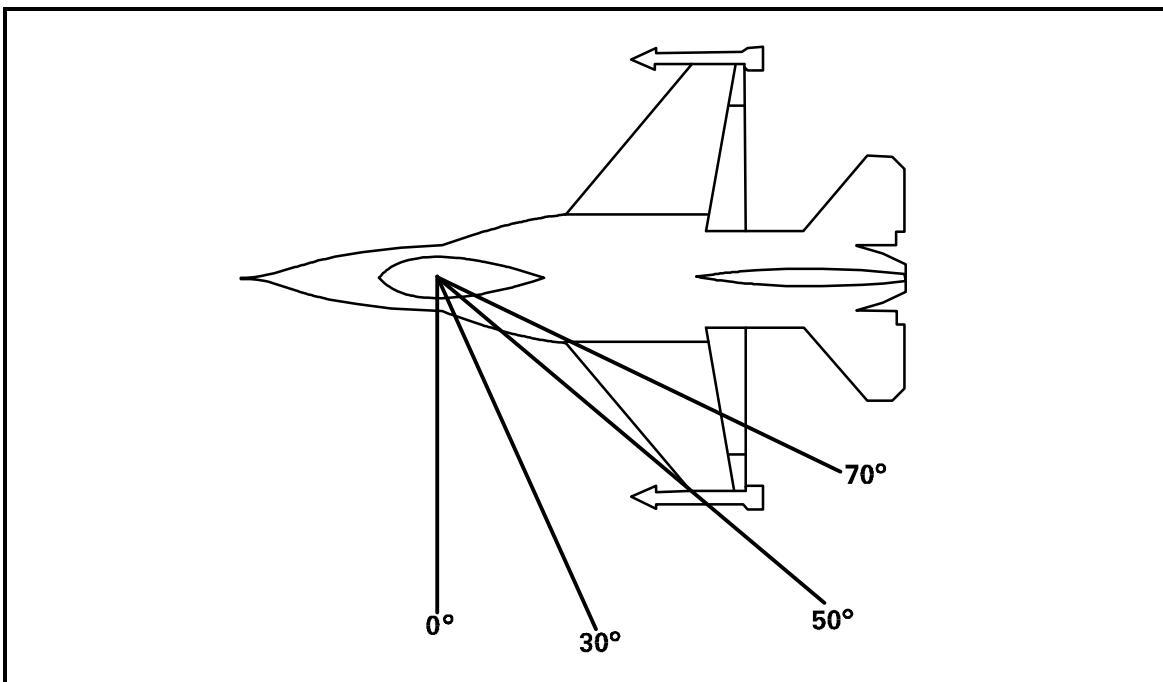


Figure 3.3 Aircraft References for Six O'Clock Look Angles

### 3.2.3. Formation Selection

The basic combat formation employed by tactical fighters is the four-ship flight. The two-ship element is the basic fighting unit. The wingman's main duty is to fly formation on his leader and to support him at all times. He is to clear the area and perform his portion of the briefed mission. A four-ship flight consists of two elements directed by the four-ship flight lead, increasing the mutual support of all. Considering the variety of air and surface threats, terrain, weather, target arrays, and mission objectives that will be encountered in carrying out a wide range of wartime taskings, there is a need for both line abreast and wedge formations. Each of these two tactical formations has unique strengths. Conversely, each has weaknesses that restrict their utility and flexibility.

For example, line abreast has several strengths. Where the major threat is from enemy fighters, it provides optimum visual cross coverage and good position for rapid maneuvering and mutual support to counter attack. Also, it diminishes the opportunity for a ground threat to be alerted by the leader's overflight and carry out a successful engagement on the wingman. (At ingress airspeeds gunners have an additional 2 to 4 seconds reaction time on a wedge wingman.) Line abreast makes it easy for the leader to check on the position and status of his wingman. It also lends itself well to simultaneous attacks by the leader and wingman against known enemy targets with distance deconfliction and turning room. On the other hand, line abreast formation has certain disadvantages. It is not practical to fly at extremely low altitude with random maneuvering. Moreover, line abreast is difficult for the wingman to achieve spacing on the leader for a sequenced attack, particularly where target location is not precisely known.

In this same regard, wedge formation has its own set of strengths and weaknesses. Wedge provides less 6 o'clock threat lookout coverage and has less flexibility in initial maneuvering to counter air-to-air attacks behind the 3/9 line. On the strength side, wedge formation can be flown successfully at lower altitude, especially in mountainous terrain, because the wingman can keep both the leader in sight and adequately scan approaching terrain. In certain threat scenarios, extremely low altitude flight can be a critically important advantage. Wedge formation also allows for good offensive air capability against a forward quarter threat and allows good maneuvering potential. Wedge also provides much greater maneuvering flexibility as the wingman handles turns of any magnitude by maneuvers in the cone on either side of the leader. Such maneuvering often is required to pinpoint targets at the last minute, and also to evade pop-up ground threats such as automatic weapons fire. Finally, wedge also has advantages for multiple attacks against the same target or target array (not all threat scenarios call for single pass tactics). Both types of low altitude tactical formations are viable and necessary in varying threat scenarios.

### 3.2.4. Formation Responsibilities

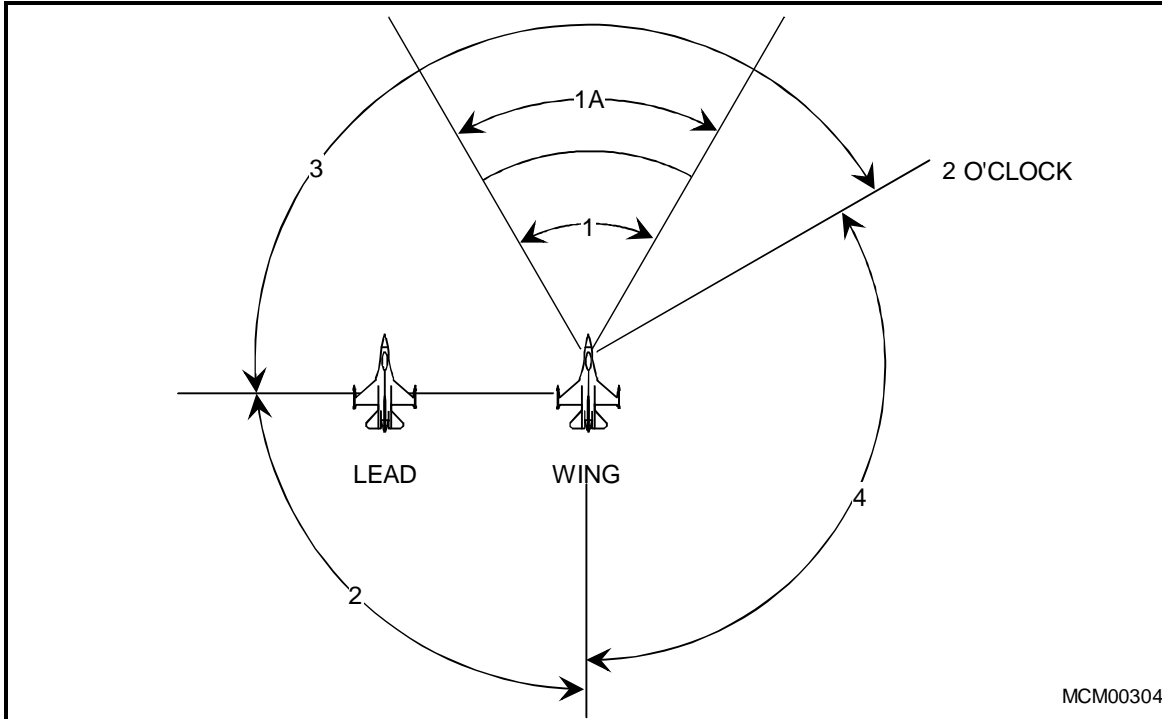
The flight lead assigns responsibilities for each flight member. Dividing responsibilities ensures each pilot has a manageable number of tasks to perform. Flight member normal responsibilities are:

- *Number One:* Primary planner and decision maker, primary navigation and radar lookout, visual lookout for mutual support of #2, and primary engaged fighter, if practical.
- *Number Two:* Maintain formation position, visual lookout, mutual support of number one. Navigation position awareness, and radar awareness as other responsibilities allow.
- *Number Three:* Support number one. Secondary planner and alternate decision maker, maintain support position for lead element, secondary navigation and radar monitor, visual lookout for number four, mutual support of the entire flight, and secondary engaged fighter, if practical.
- *Number Four:* Maintain formation position, visual lookout for the flight, mutual support of number three. Navigation position awareness, and radar awareness as other responsibilities allow.

### 3.2.5. Time-Sharing

The goal on every low level training mission should be to improve the development of this cross-check. Practice and discipline are essential to maximizing visual mutual support. On each mission, pilots must start with the basic NEAR ROCKS, FAR ROCKS, CHECK SIX pattern and build up the visual search arena as allowed by task saturation, threat and flight conditions. When encountering extremely rough terrain, defensive reactions, navigation turns, etc., drop the lowest priority sectors in

order. There will be times, such as hard turns, when only NEAR ROCKS can be cross-checked. The key is to quickly re-establish the cross-check one sector at a time as tasks permit.



**Figure 3.4 Lookout Responsibilities**

Although the pilot has a myriad of responsibilities, he can only perform one task at a time. Therefore, he must employ a time sharing plan to quickly and efficiently accomplish many tasks. The following is an example of a time share plan for lookout responsibilities. The airspace around the aircraft is divided into sectors and each sector is assigned a priority based on lookout responsibilities (Figure 3.4). This plan is developed from a perspective of number two in a four-ship, but the principles apply to all positions in the flight.

*Sector 1:* This is the hub of the cross-check. It is divided into two parts. Sector 1 is NEAR ROCKS, the rocks that will affect your flight path in the next 10 to 15 seconds. This sector is the highest priority sector and is the center of the cross-check. NEAR ROCKS are the ones that present an immediate threat. Sector 1A is FAR ROCKS, the terrain that will affect our future maneuvering. Pilots that look ahead at the FAR ROCKS are smooth in their maneuvering to maintain position or navigate because they see the mountain peaks and valleys in time to make small corrections.

*Sector 2:* Besides avoiding the ground, the next most important area for lookout space is inside the flight's six o'clock. Sector 2 allows number two to monitor his formation position and check lead's six o'clock. Sectors 1, 1A and 2 make up the basic cross-check—NEAR ROCKS, FAR ROCKS, CHECK SIX.

*Sector 3:* Once these responsibilities are completed, other areas can be brought into the cross-check. The next sector is inside the flight ahead of the 3/9 line. Searching this area can detect bandits in a conversion, as well as SAMs that may be fired from the front quadrant. Sector 3 is lower priority than Sectors 1, 1A and 2; therefore, it should be searched less frequently. NEAR ROCKS and FAR ROCKS must be checked during each search cycle. The frequency of search is dependent on pilot task saturation.

*Sector 4:* When proficient enough, expand the search to a 360° lookout by picking up Sector 4. Sector 4 is outside the flight, ahead/behind the 3/9 line. This sector is the lowest priority—the wingman owes it to his flight lead to provide inside the flight lookout before dedicating time to this sector.

### 3.2.6. Radar Integration and Cockpit Tasks

Where does the radar fit into the cross-check? The answer is in the responsibilities section listed above. Flight position will determine where to incorporate radar lookout. As lead or three, it should be part of Sector 3. As two or four, the radar should be after Sector 4. Performing cockpit tasks is the next problem. The best plan is accomplish as many as possible prior to entering the low altitude regime. Switch errors are often made in the heat of battle. When switch changes are required, substitute them for a cross-check sector search. For pacing, do one task, then reference your flight path before moving to another task.

## 3.3. Two-Ship Formations

### 3.3.1. Line Abreast

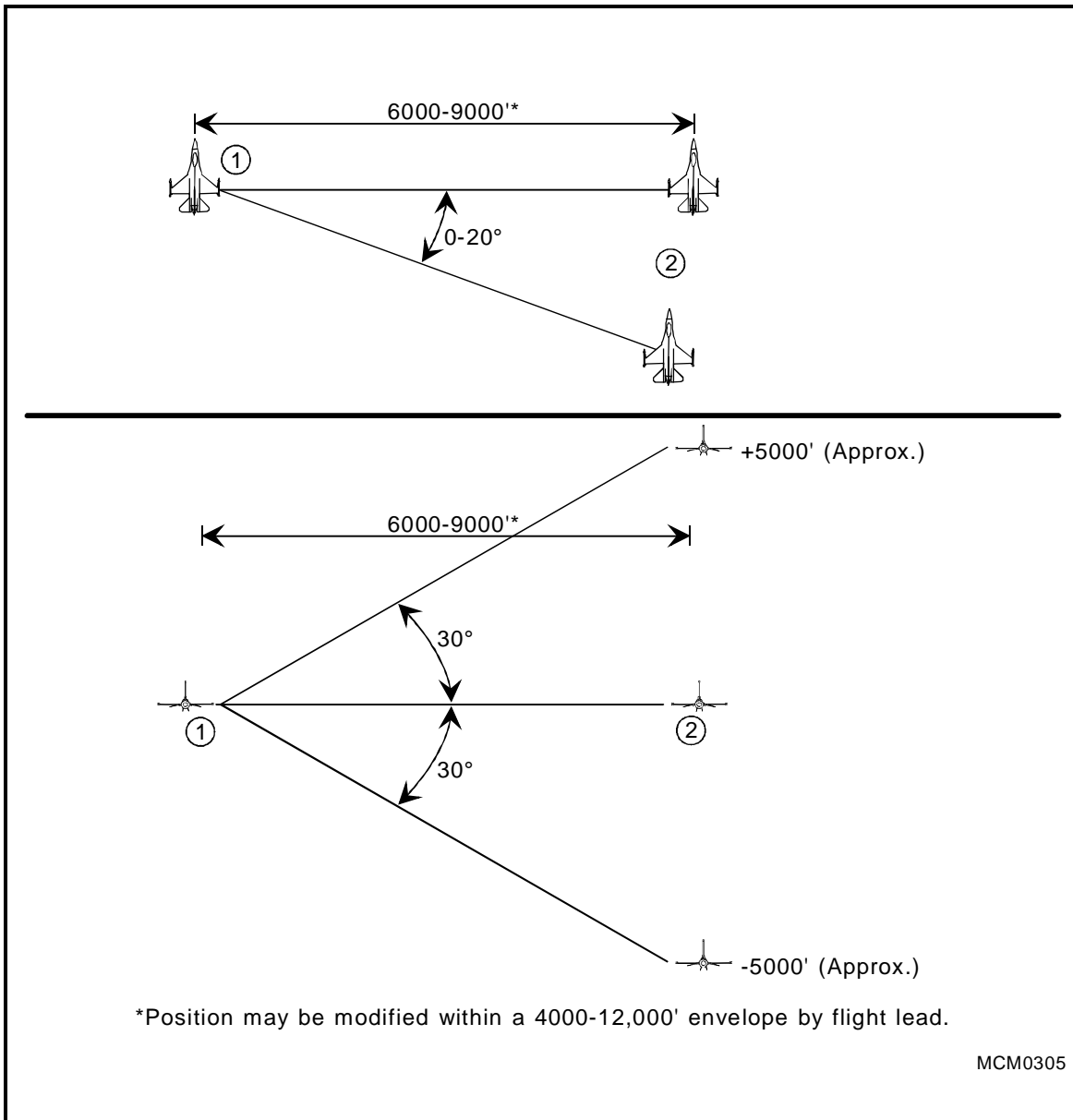
Line abreast formation is a position 0° - 20° aft, 4000' - 12,000' spacing, with altitude separation. At low altitude, the wingman should fly no lower than lead.

Unless further defined by the flight lead, wingmen will fly in the 6000' - 9000' range and strive for the 0° line (Figure 3.5). The 6000' - 9000' position provides optimum visual and firepower mutual support for threats from the beam and six o'clock positions. The flight lead may tailor the parameters of this formation to meet particular situations or requirements. For example, in poor visibility conditions at low altitude, the wingman may be briefed to fly 4000' - 6000' lateral spacing. For certain air-to-air scenarios, the briefed lateral spacing may be 9000' - 12,000' to enhance six o'clock visual coverage while complicating the enemy's visual acquisition of all aircraft in the formation. The wingman needs to maintain a formation position which allows him to perform his other responsibilities and not spend all his time flying formation.

Each pilot must be in a position to detect an adversary converting on the wingman's stern prior to that adversary reaching firing parameters. Against an all-aspect, all-weather adversary this may not be possible. F-16 rearward visibility field-of-view (FOV) is not a limiting factor, as it is in most other aircraft.

This formation allows element members to be in position to quickly bring ordnance to bear when a threat is detected. A vertical stack of 2000 to 6000 feet, when applicable, minimizes the chance of simultaneous detection by a bandit.



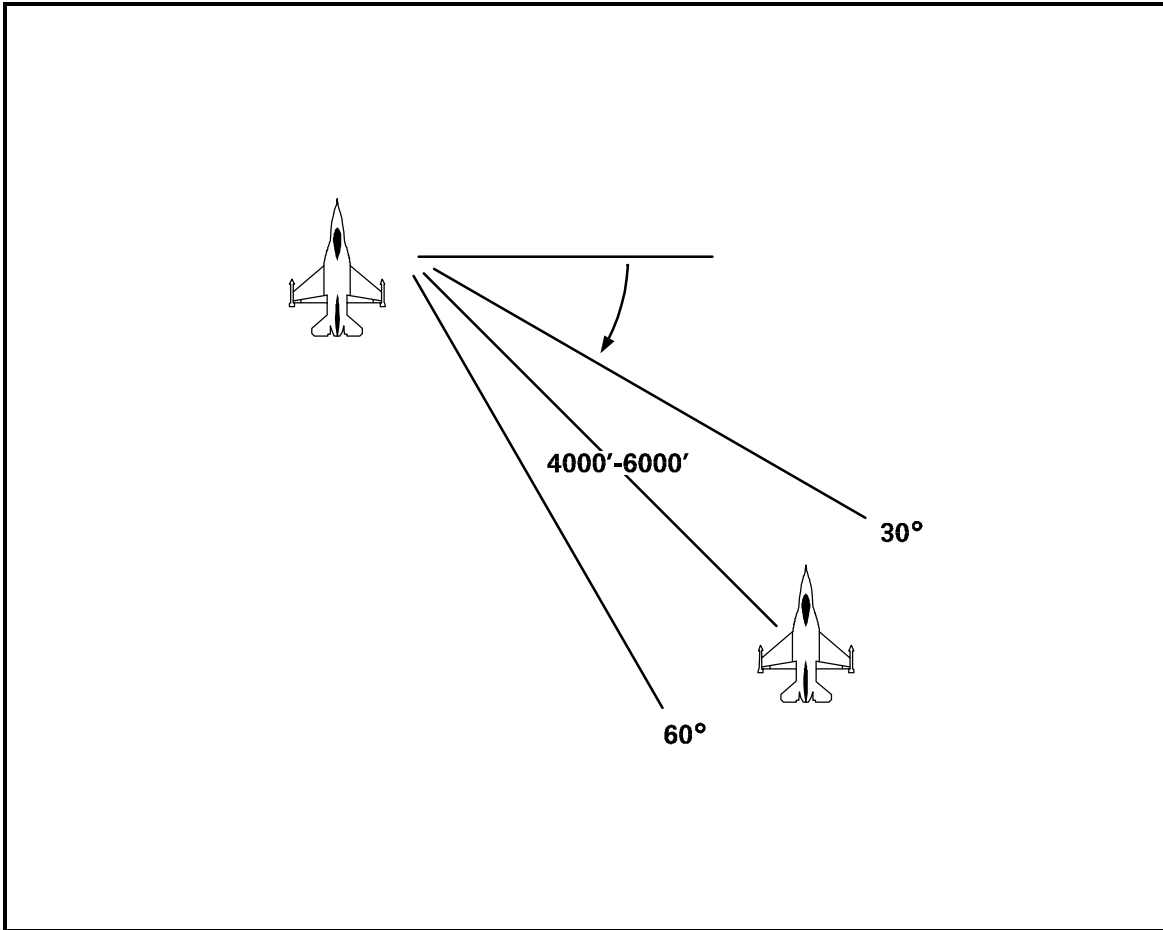


**Figure 3.5 Two-Ship Line Abreast**

### 3.3.2. Wedge

Wedge is defined as the wingman positioned from 30° to 60° aft of the leader's 3/9 line, 4000' to 6,000' back (Figure 3.6). The advantages of wedge are that the leader is well protected in the 6 o'clock area and is free to maneuver aggressively. The wingman may switch sides as required during turns. He may also switch sides as required to avoid terrain, obstacles or weather but must return to the original side unless cleared by the leader. The flight lead may extend the formation spacing to 12,000' to meet particular situations or requirements.

The most significant disadvantage of the wedge is that it provides little to no six o'clock protection for the wingman. Lead changes, if required, are difficult to execute.



**Figure 3.6 Two-Ship Wedge**

### 3.3.3. Fighting Wing

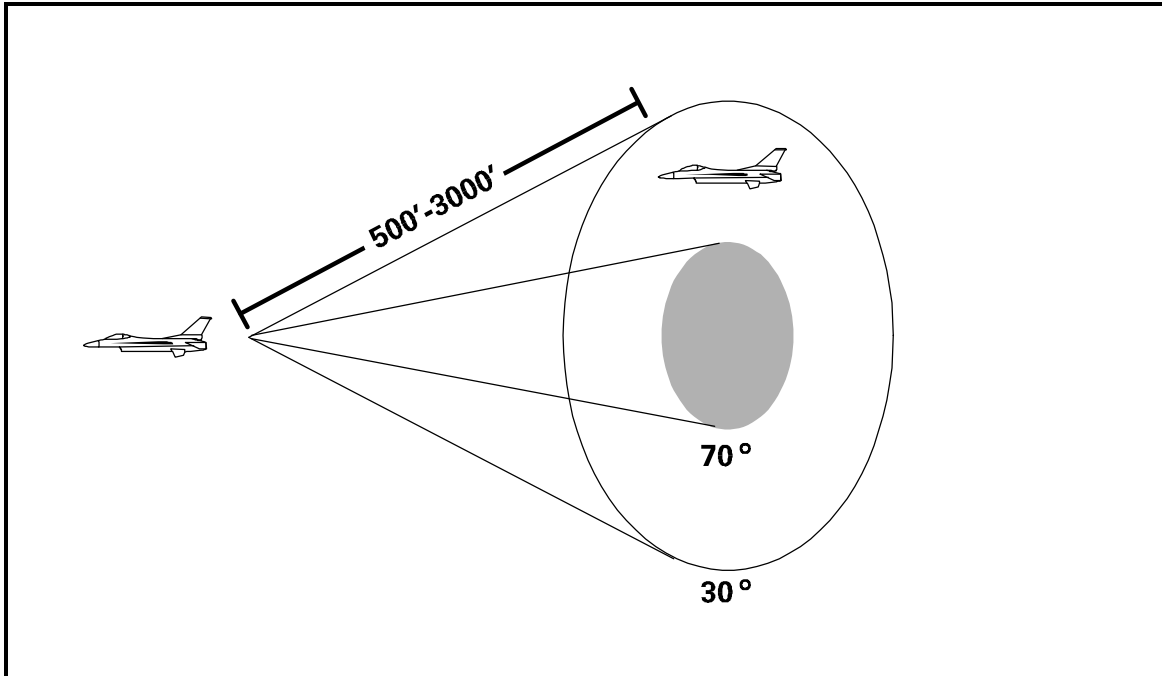
This formation, flown as a two-ship, gives the wingman a maneuvering cone from 30° to 70° aft of line abreast and lateral spacing between 500' to 3000' (Figure 3.7). Number two maneuvers off lead with cutoff as necessary to maintain position. This formation is employed in situations where maximum maneuvering potential is desired. Arenas for use include holding in a tactical environment or maneuvering around obstacles or clouds. This formation is employed by elements when flying fluid four.

Advantages:

- The formation allows the element to maintain flight integrity under marginal weather conditions or in rough terrain.
- Allows for cockpit heads down time for administrative functions when in a low-threat arena where hard maneuvering is not required.

Disadvantages:

- Poor to nonexistent six o'clock coverage.
- Easy detection of formation by single threat.



**Figure 3.7 Fighting Wing**

### 3.4. Four-Ship Formations

The four-ship is under control of one flight lead and is employed as a single entity until such time as it is forced to separate into two elements. At no time should an element sacrifice element integrity attempting to maintain the four-ship formation. Each two-ship element should have its own radar and visual plan so that no changes will be required if the four-ship is split into two-ships.

#### 3.4.1. Box/Offset Box

In the box formation, elements use the basic line abreast two-ship maneuvering and lookout principles. The trailing element takes 1.5 to 3 NM separation, depending on terrain and weather. The objective of the spacing is to give maximum separation to avoid easy visual detection of the whole formation, while positioning the rear element in a good position to immediately engage an enemy converting on the lead element. Because the F-16 is difficult to see from a direct trail position, a slight offset will facilitate keeping sight of the lead element (Figure 3.8). Use of air-to-air (A-A) TACAN between the elements, and the radar in the rear element, will help keep the proper spacing. However, proper emission control may preclude their use in combat. The arrowhead variation makes number two's formation easier, freeing him for more lookout (Figure 3.9). *NOTE:* In an ATC environment, the trailing element should fly 1 NM or less if standard formation is required. Formation maneuvers are initiated by element leaders. Number three maneuvers to achieve prebriefed spacing on the lead element (based on threat, mission, weather, etc.).

Advantages:

- The formation provides excellent mutual support and lookout.
- The rear element is positioned to engage an adversary making a stern conversion on the lead element.
- It is difficult to visually acquire the entire flight.
- Element spacing for an attack is built into the formation.

Disadvantages:

- The formation is difficult to fly in poor visibility and rugged terrain.
- Depending on position, the trailing element may be momentarily mistaken as a threat, especially if staggered too much off to one side.

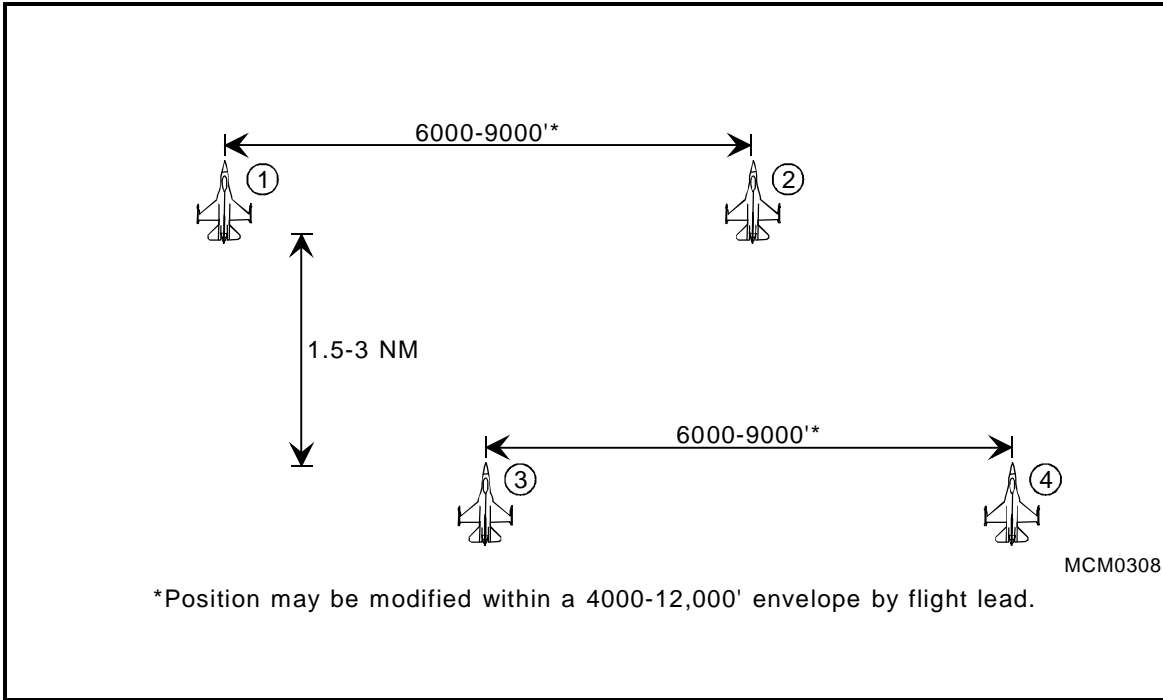


Figure 3.8 Four Ship Offset Box

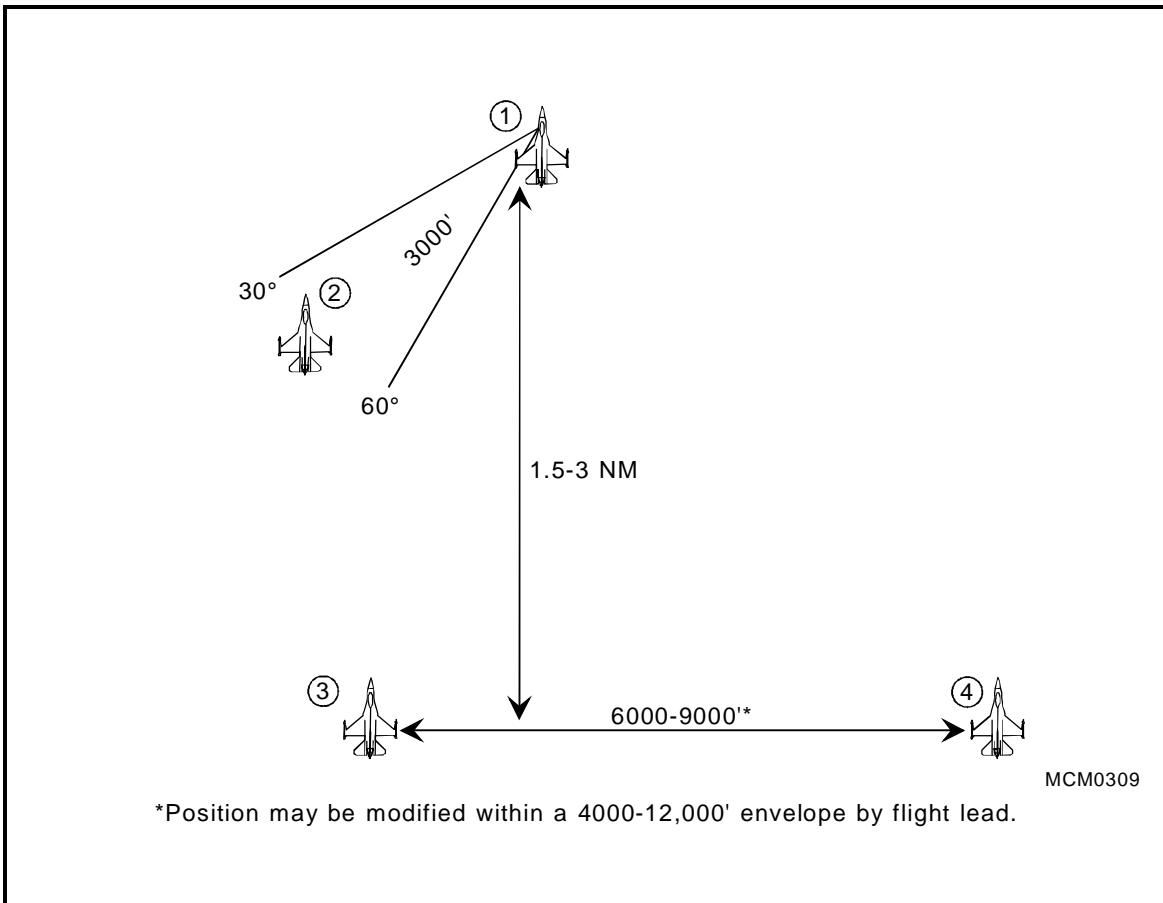


Figure 3.9 Arrowhead Formation

### 3.4.2. Wedge

Elements are in two-ship wedge with the trailing element lead 1.5 - 3 NM back, offset as required to maintain visual (Figure 3.10). Number two flies off of number one, maneuvering with cutoff as necessary to maintain position. Number three flies off of number one, maneuvering as required to maintain visual. Number four flies off of number three.

Advantages:

- Very offensive for air-to-air threats forward of the 3/9 line.
- Inexperienced wingmen may find it easier to maintain a visual on lead and stay in formation.
- The formation permits four aircraft to maintain flight integrity under marginal weather or extremely rugged terrain conditions.

Disadvantages:

- Six o'clock lookout may be poor.
- Formation easily detected by single threat.
- The defensive maneuvering flexibility of the flight is very limited.
- Number two must be disciplined and fly no further than 6,000 feet from lead to avoid conflict with trailing element.

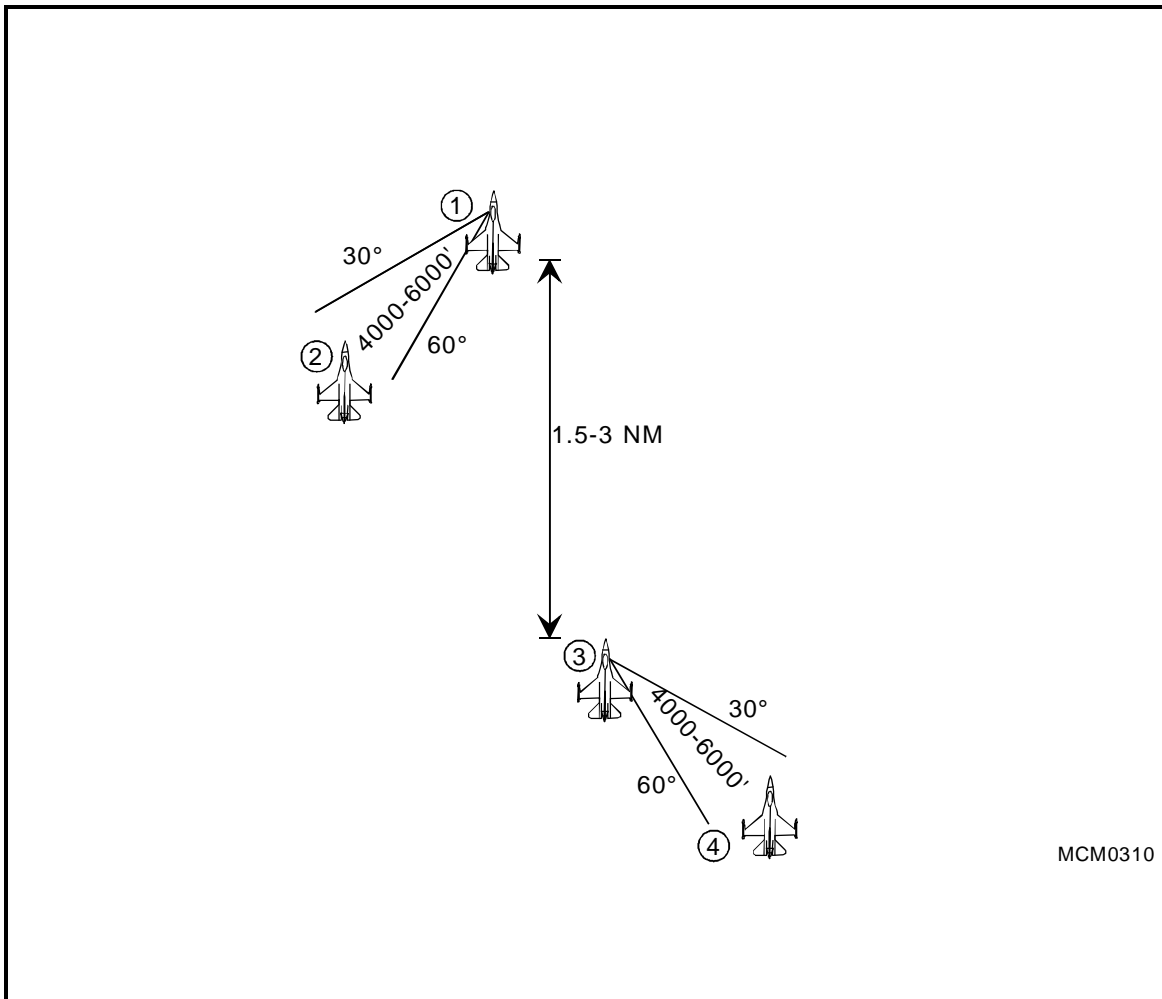
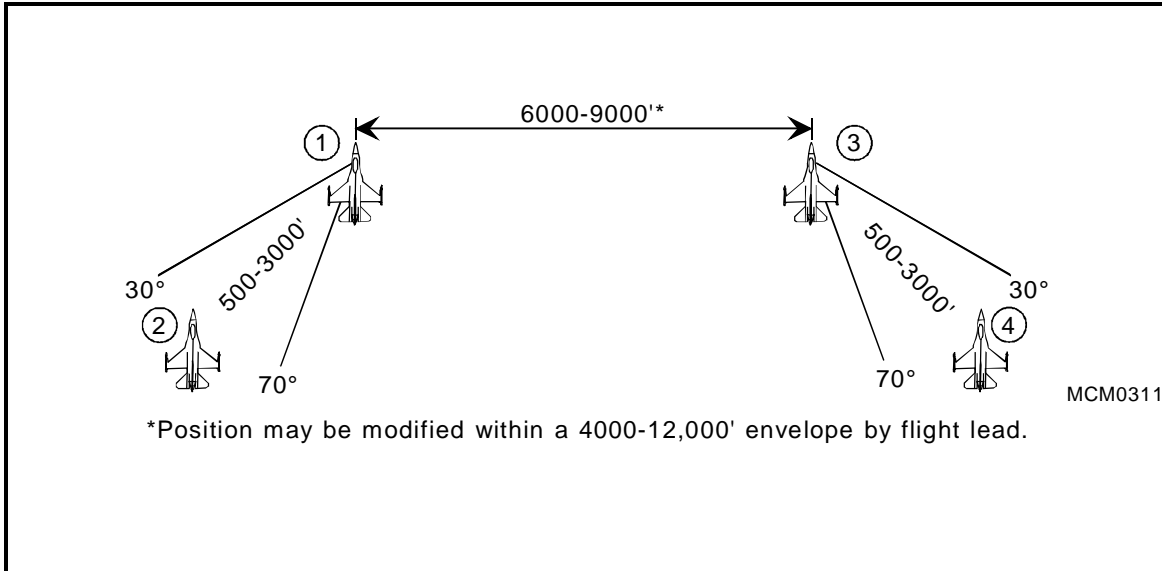


Figure 3.10 Four Ship Wedge Formation



**Figure 3.11 Fluid Four Formation**

#### 3.4.3. Fluid Four

Element leads maintain line abreast formation, while wingmen assume fighting wing (Figure 3.11). Number three maneuvers off number one as if in line abreast. Number two and number four maneuver off their element leaders to maintain the outside of the formation. Element leads are responsible for deconfliction of elements when crossing the opposing element's six o'clock.

Advantages:

- Inexperienced wingmen are kept close for ease of maneuvering.
- Four-ship maneuverability is good.
- Formation provides concentration of force.
- Easily converts to three-ship when one aircraft falls out.

Disadvantages:

- Adversary can acquire all four aircraft.
- Defensive maneuvering rapidly becomes confusing due to the proximity of aircraft.
- Cumbersome to maneuver at low altitude in rough terrain.

#### 3.4.4. Spread Four

Element leads maintain the same spacing as for fluid four, but wingmen position themselves 0° to 30° back from their element leads and 6000' to 9000' spread (Figure 3.12). Increased lateral spacing for wingmen facilitates maneuvering. Each element uses fluid maneuvering. Number three flies off number one. The elements are not always required to be line abreast. On some occasions they may be briefly in trail.

Advantages:

- Spread formation makes it difficult for an adversary to visually acquire the entire flight at once.
- Firepower is maximized for BVR weapons employment.

Disadvantages:

- Maneuvering is difficult if the line abreast position is maintained.
- Very difficult for wingmen to fly at low altitude.

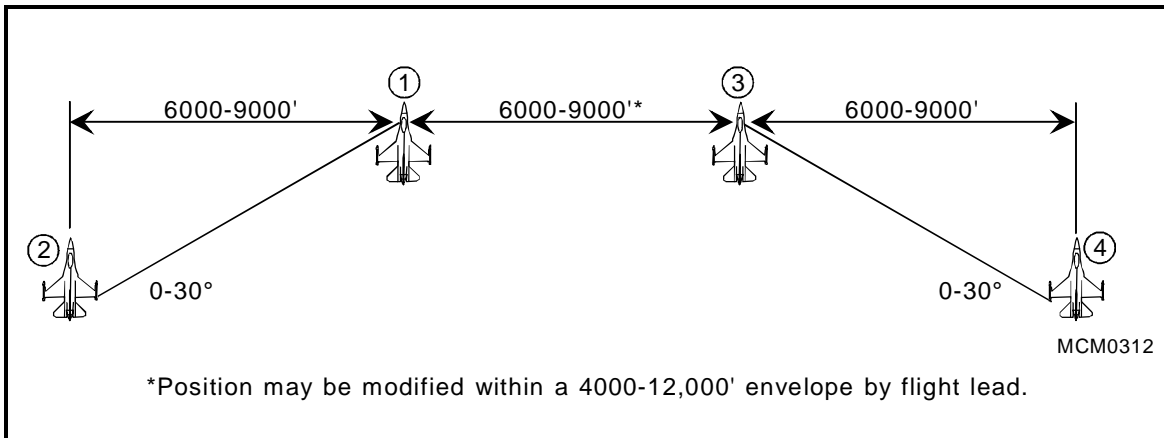


Figure 3.12 Spread Four Formation

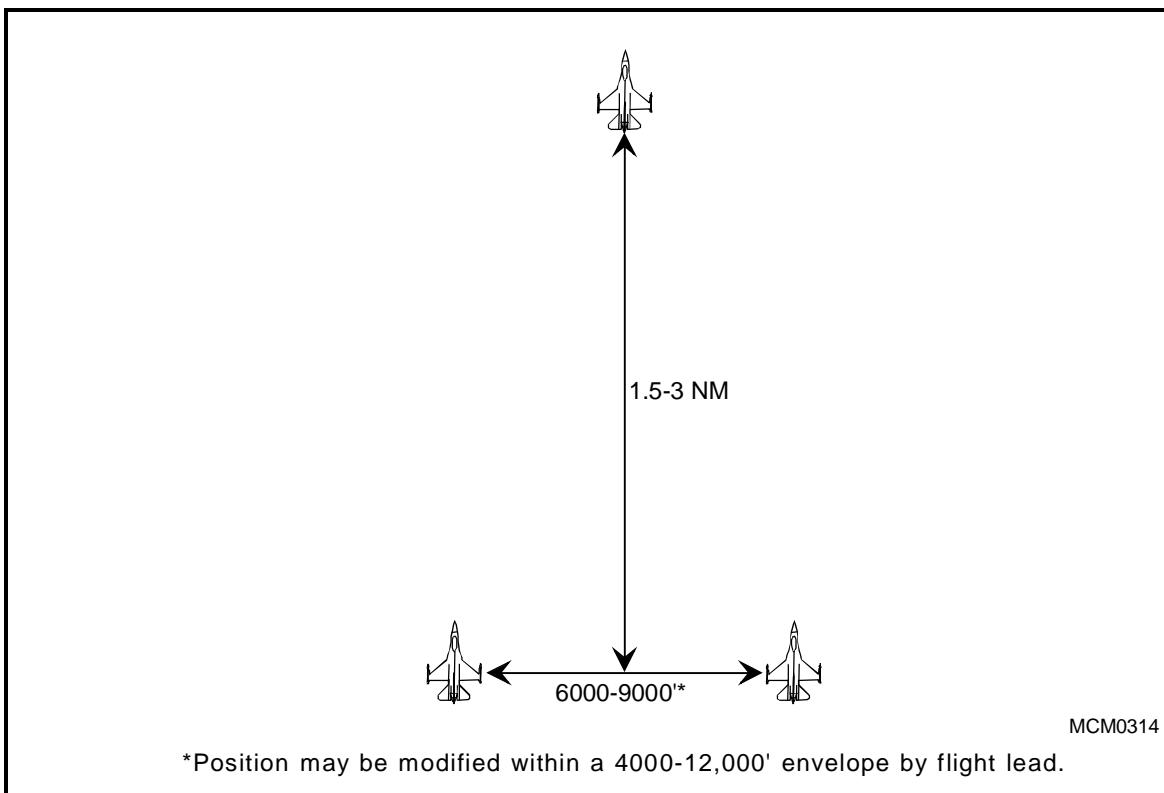


Figure 3.13 Three Ship Vic

### 3.5. Three-Ship Formations

There may be occasions when a priority mission requires maximum available aircraft and a three-ship is the only alternative. Mutual support requirements to ensure survivability and recovery are paramount; therefore, a three-ship contingency should be briefed on all four-ship missions. On these occasions, the following three-ship formation discussion is applicable.

Responsibilities:

- **Number One**—navigation, then radar and visual lookout.
- **Number Two**—visual and radar lookout, back-up navigation.
- **Number Three**—visual, then radar lookout.

### 3.5.1. Vic Formation

This is basically the arrowhead four-ship without number two (Figure 3.13). The lead aircraft maneuvers as desired. The trailing element uses line abreast maneuvering to follow.

### 3.5.2. Wedge

This is the same as four-ship wedge without number four.

### 3.5.3. Fluid Three

This is the same as fluid four with one airplane missing. If the three-ship is caused by one aircraft falling out from a briefed four-ship, the following position changes should be followed: if lead falls out, number three assumes lead and number two moves to line abreast; if number three falls out, number four moves up to line abreast; if number two or four fall out, there are no changes.

### 3.5.4. Three-Ship Spread

This is the same as spread four with one aircraft missing. Roles and responsibilities caused by fall out from a four-ship are the same as fluid three.

## 3.6. Tactical Turns

### 3.6.1. Line Abreast Formations

These may be turned using the radio or "radio silent" signals. The line abreast formation compensates for its inherent maneuvering problems with specialized prebriefed procedures. These include the type of turns to be made, the parameters at which these turns will be made, and the method by which these turns will be initiated. The turns consist of 45° - 90° delayed turns, in-place turns, crossturns, weaves, and check turns (Figures 3.14 and 3.15). The parameters for the turns are briefed by each flight leader and usually consist of the speed, "G", and the power required in the turn. The method of turn initiation is generally by radio call, wing flash, or check turn.

### 3.6.2. Radar/Visual Lookout

Also briefed are the individual areas of visual and radar responsibility. The line abreast formation, while very common and widely accepted, has pitfalls which the inexperienced must overcome for complete effectiveness.

Probably the first shortcoming is the flight leader who assumes that everyone flies formations exactly the same. This pilot may skimp their briefing, leaving some doubt as to one or more of the necessary parameters or responsibilities. The only way to prevent this oversight is strict adherence to squadron standards or a thorough briefing on all planned or potential formations. Do not leave the flight briefing with unresolved questions or if unclear on formation positions and responsibilities.

The second trap is the flight leader who does not realize the problems of his wingman when maneuvering in a random manner. Specifically, if the flight leader does not keep consistent formation parameters (heading and airspeed), he forces his wingman to devote excessive time maintaining position instead of visual/radar search. Drifting left or right after establishing a direction is an example. Likewise, a 10° check turn into a lagging wingman is preferable to the time and effort required for that wingman to drive forward to the briefed position. Exact headings are not critical; however, mutual support responsibilities are vital. This is not to say a leader flies off his wingman. He can make the wingman more effective by being considerate. If your situation requires more than random turns, a more maneuverable formation should be flown.

### 3.6.3. Maneuvering With Unrestricted Comm

When the radios are available, some flight leads will use them. The tactical turns will normally be initiated by the flight lead. The preparatory command for a turn is flight call sign and the command of execution is the type turn called. **EXAMPLE:** "Falcon One, 90 right" Turns of 90 are assumed to be delayed types unless called otherwise. **EXAMPLE:** "Falcon One, hook right."



#### 3.6.4. Radio Silent Maneuvering

There may be times when radio silent procedures are used to maneuver the flight. Under these conditions certain variables must be held standard (Figures 3.16 and 3.17). The basic "contract" between flight members is:

- The wingman will always strive for the briefed position.
- The man caught in front is responsible for regaining the briefed position (weave, shackle, etc.). This should be covered in your flight briefing.
- The wingman does not exceed 90° off the leader's heading.
- The wingman and lead will use the same basic type of tactical turns at all altitudes (normally, MIL power and 4 G turns).
- Lead initiates all turns. There are no start turn signals from wingman to lead.
- A turn away from the wingman will be signaled by lead (wing flash, check turn, etc.).
- A turn into the wingman is signaled by a turn into the wingman.
- If at low altitude, the wingman does not stack lower than the leader.

During tactical radio silent turns at low altitude, the man being turned into may do a 30° check turn away from the other man to deconflict flight paths and/or signify acknowledgment. At medium or high altitude, this check turn may be omitted, at flight lead discretion. Flight leads are expected to specify whether or not check turns will be used in this way. Also, flight members must differentiate between radio silent commands (big wing flash) and belly checks, or terrain masking. (At low altitude, nose rate movement is the best way to differentiate.) Visual lookout responsibilities shift forward as lower altitudes are encountered. The percent of time clearing for airborne threats is reduced at low altitude.

##### 3.6.4.1. Turns Into the Wingman

- Lead initiates the turn by turning into the wingman, normally at MIL power and a sustained 4 G's.
- The wingman continues straight ahead (or checks 20° - 30° as briefed) and searches the new six through lead.
- If lead rolls out short of passing through the wingman's six o'clock, the wingman now weaves to line abreast (delayed 45° - 60° turn).
- If lead turns through the wingman's six o'clock, the wingman assumes a 90° turn and turns to regain line abreast.
- If a 180° turn is required, it will be accomplished in increments of two delayed 90° turns.

##### 3.6.4.2. Turns Away from the Wingman

- Lead makes a distinctive wing flash or check turn of approximately 30° to signal the turn.
- The wingman sees the flash and begins the turn into lead using the briefed G and power setting (i.e., MIL, 4 G sustained, etc.).
- If lead wants a delayed 45° - 60° turn, he turns into the wingman when the wingman obtains the desired heading. This is the wingman's command to roll out.
- If lead wants a delayed 90° turn, he allows the wingman to continue turning through his six o'clock.
- If lead wants to turn 180° away, he initiates the turn with a continuous 180° turn.

##### 3.6.4.3. Check Turns

- Lead turns to the desired heading using a gentle turn.
- Wingman sees either a divergence or convergence and strives for line abreast using an S-turn, vertical, or power.

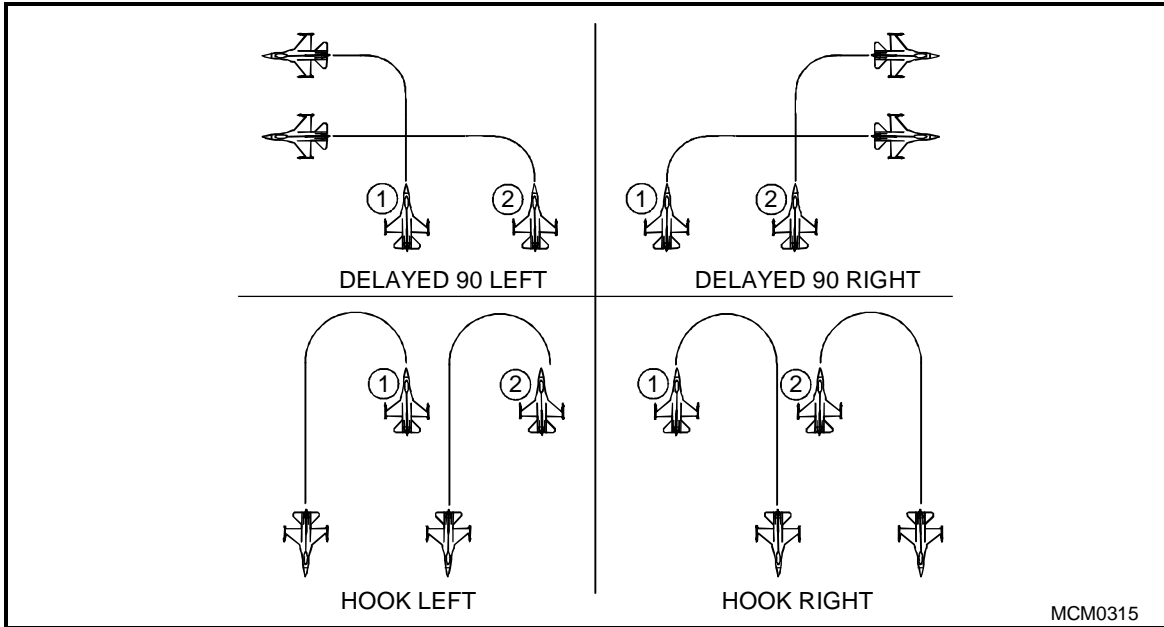


Figure 3.14 Delayed 90° and Hook Turns

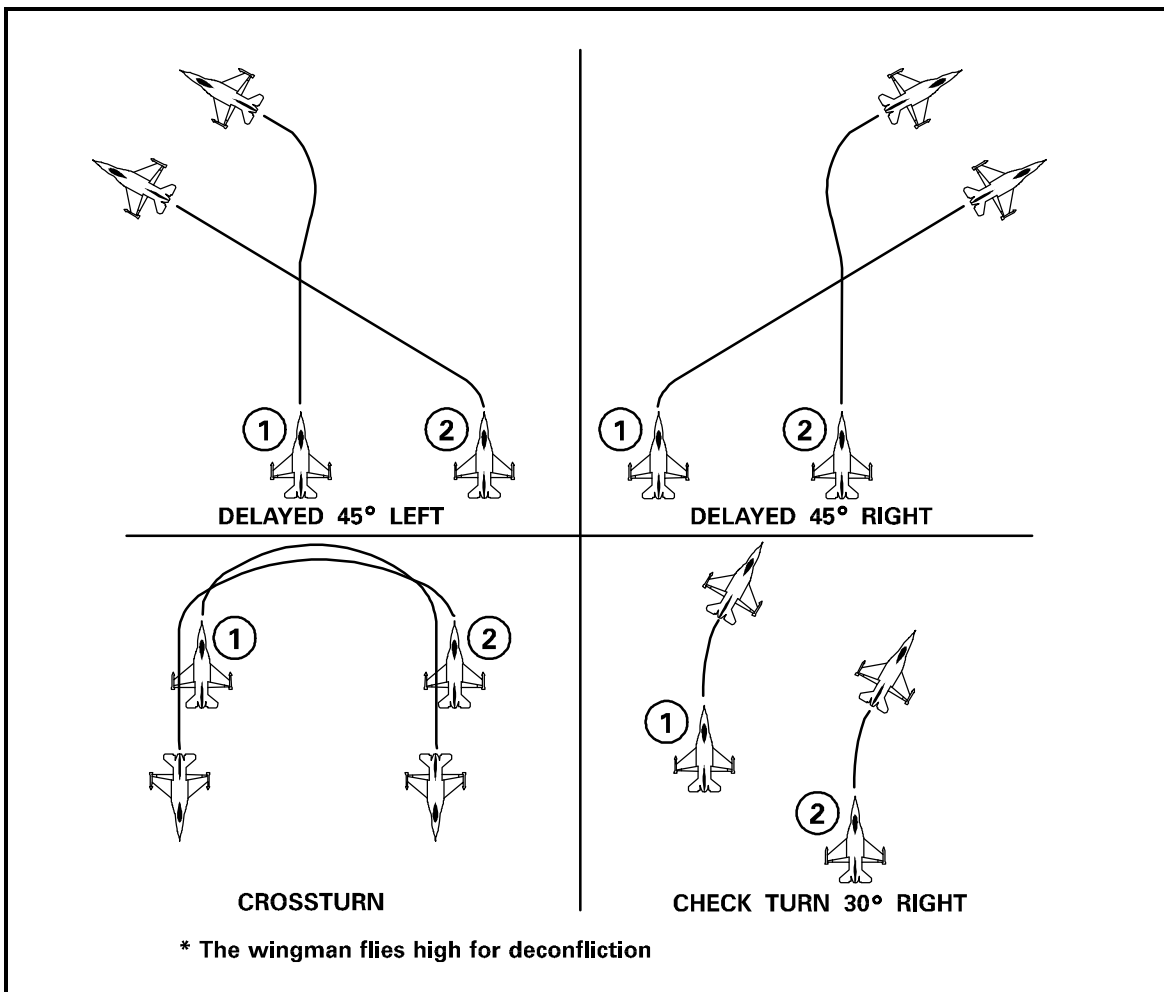


Figure 3.15 Delayed 45°/Crossturn/Check Turns

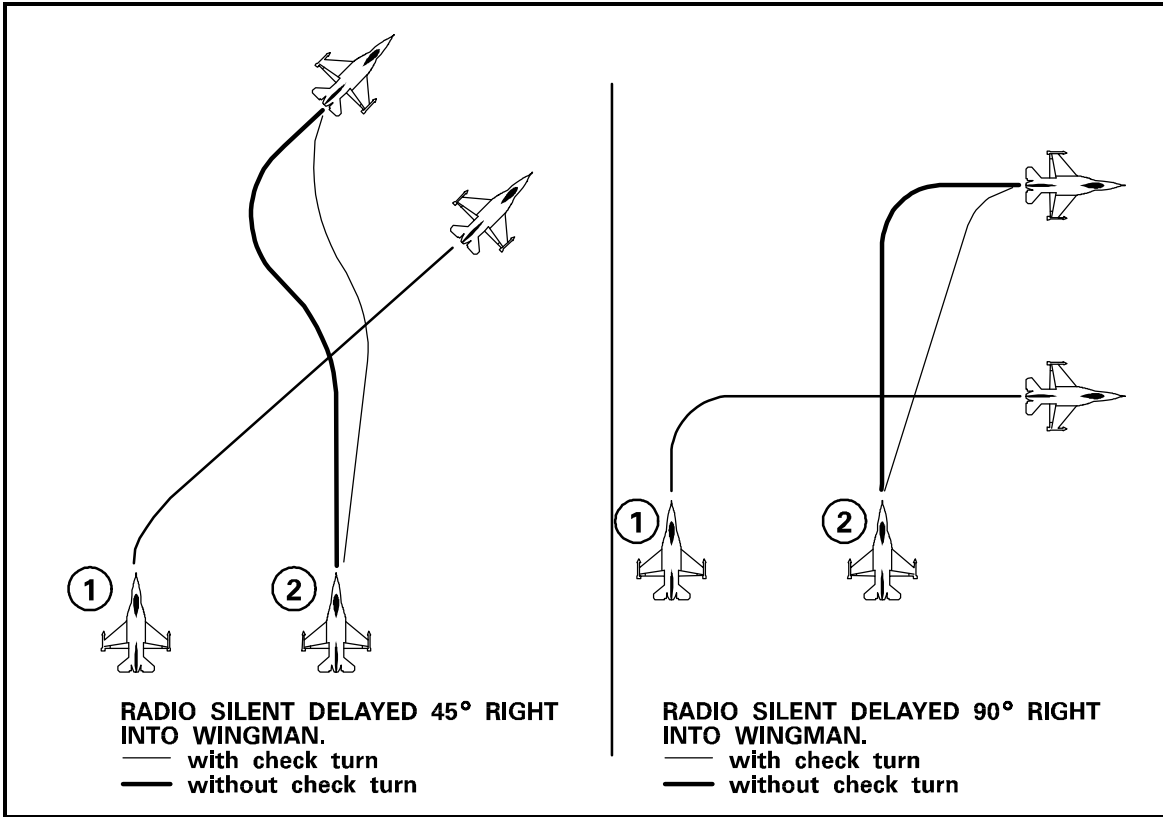


Figure 3.16 Radio Silent Turns Into Wingman

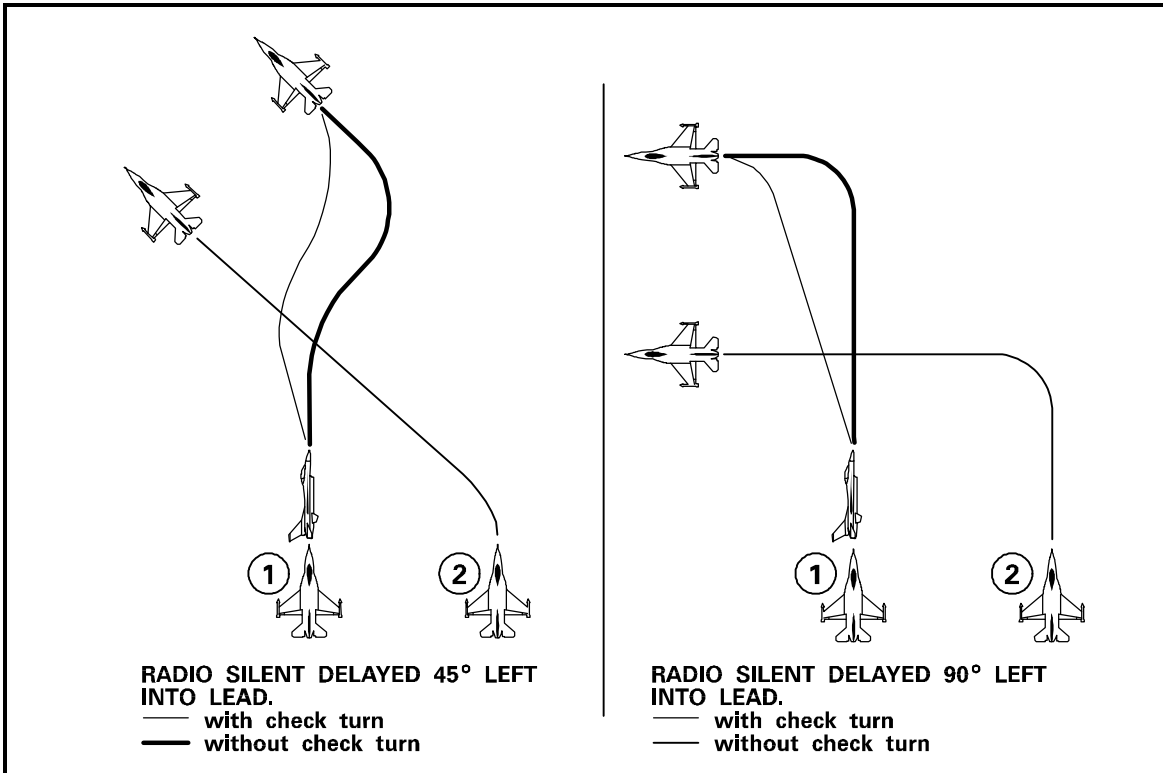


Figure 3.17 Radio Silent Turns Away From Wingman

---

## Chapter Four

### AIR-TO-AIR

#### 4.1. Introduction

The purpose of the Air-to-Air (A/A) chapter is to review the basic training spectrum of the F-16 in aerial combat. This training consists of a series of mission elements and types that use a building block approach to reach the required level of proficiency. The areas include preparation, system/fence checks, aircraft handling characteristics (AHC), basic fighter maneuvers (BFM), air combat maneuvers (ACM), intercepts, and gun employment. Aerial combat is by far the most difficult aspect of flight for the fighter pilot to understand and master. The arena is very dynamic, and the skills used must be learned over time. Personal desire and discipline will determine how quickly the individual masters the required skills. To reach the end objective of achieving a first look, first kill capability, you will train in an environment which begins with the basics of a close-in engagement and then progress to beginning the engagement beyond visual range (BVR). Your training will emphasize not only offensive skills, but high-aspect and defensive skills as well. Furthermore, your training will transition from 1 v 1 maneuvering to operating as a team to provide mutual support as elements and flights.

#### 4.2. Preparation

This is arguably the most important aspect of each and every mission. Spend some time thinking about what your about to do, and prepare adequately for that mission. The following is a list of important steps within this process:

- Contact the flight lead early and get an idea of the scenario and his game plan. He will have some tasks for you to accomplish prior to the briefing. These tasks are likely to include weather, threat, mission planning, or ordinance briefings.
- G-Tolerance, and loss of consciousness are persistent problems. A regular exercise program is your best preparation, and combined with a proper G straining maneuver the high G loads of aerial combat can be managed effectively. It is also important to get a good body/neck warm up prior to getting in the cockpit. For more on this subject refer to chapters 2 and 9 of this manual.
- Knowing your aircraft is vital to the success of the mission. The Dash-1 is a good place to start, but for further information refer to avionics manuals, and the Dash-34.

Preflight the aircraft and armament in accordance with the Dash-1 and Dash-34 checklists. If the canopy is dirty, have the crew chief clean it. Dirt, oil, and bugs can hamper your vision, especially if the sun hits them at various angles. It is an arena where equations and theories are dynamic, and where experience and understanding of basic fighter maneuvers are the keys to success. The skills used in aerial combat are learned over time and the interest, desire, and personal discipline of a pilot are important factors in speeding up this learning process.

#### 4.3. Aircraft Handling Characteristics (AHC)

Before a fighter pilot can employ the F-16 to its optimum use, he must understand his limits within the F-16's capabilities and the F-16's limits within its flight envelope. To develop a sense of aircraft performance and potential, without constant reference to flight instruments, one needs to fly the aircraft in a series of maneuvers that explores the aircraft's flight envelope and reinforces the pilot's awareness of aircraft performance. Exercises and maneuvers that expose the pilot to various parameters within the F-16's flight envelope are: the horn awareness and recovery training series (HARTS), aerobatics, and advanced handling maneuvers. Refer to Chapter 9 for a detailed description of aircraft handling maneuvers.

#### 4.4. Weapon Systems Check

Before entering the combat arena, know the status and capability of your weapon systems. The following technique should serve as a good starting point for developing your own weapon systems check. It should be accomplished with minimum use of time and fuel, so strive for an efficient and easily

remembered sequence. One purpose of the weapons systems check is for you to practice and verify the proper operation of the switchology required to get to various modes you will use on your specific mission. Use the check to ensure the REO/MFDs are set up as desired, and to practice selecting the appropriate modes quickly. Practice in selecting ACM and the desired scan pattern will also make the action second nature during engagements. This is also a good time to review HUD and radar symbology. As you complete the weapons systems check, ensure proper avionics and weapons operations. Early detection of any malfunctions or limitations which could limit mission effectiveness will help you adjust your game plan prior to entering combat.

Position yourself between 1500' and 4000' aft of lead and spend as little time as possible at dead six, avoid lead's jet wash throughout the weapons check. Once established in that position maintain at least as much airspeed as lead. Use geometry and power to control closure. Ensure the AIM-9 is cooled.

With the master arm in simulate, put the target in an ACM scan pattern, and select DGFT/MSL OVRD on the throttle. Verify proper HUD symbology. And then:

- Obtain an ACM lock.
- Verify HUD/SMS/MFD symbology.
- Check TD box tracks target.
- Select BP/SPOT/SLAV.
- Set missile tone volume. Set it fairly high. The tone volume is proportional to the strength of the heat source. A maximum range shot is a lot further away than a weapon system check shot.
- Step through and uncage all missile seeker heads and check tones for self-track capability. Verify HUD symbology.
- Break lock—radar returns to search and missile remains in the self track mode.
- Depress the Z axis on the cursor enable switch and verify the AIM-9 goes to BORE (if normal setting is SLAVE).
- Recage the seeker head and confirm it returns to the missile boresight position.
- Relock, using an alternate ACM mode (BORE, 10 X 40/10 X 60, SACM).
- Break lock and relock using the third ACM mode.

Place weapons select switch to outboard position (DGFT):

- Verify the radar maintains a lock on.
- Place missile diamond over target and obtain a missile tone rise.
- Ensure wingspan is properly set and confirm range with lock-on information.
- S-turn through the target to verify dogfight gun symbology is programming properly.
- Break the radar lock.
- Check target locator line for proper indications and review your canopy code.
- Complete visual range calibration and return to tactical formation or change lead positions, as briefed.

*CAUTION:* Do not practice pickling missiles during the weapons check. When carrying live missiles, the above check should be modified to conform to squadron standards.

Be alert for pop-up targets on the radar en route to the area and lock-on to a couple both for practice and to check the system. The radar warning receiver (RWR) should be on and checked for volume and azimuth while flying as target for the wingman's weapon systems check.

#### 4.5. Fence Check

In actual combat, most of the items in the fence check should be done prior to or right after takeoff—a few at FEBA crossing. For peacetime training this will vary based on training areas/restrictions; portions of the check will be accomplished in/approaching the area or not at all. Going left to right around the cockpit (items unique to the F-16C have an \*):

- Tank inerting—as briefed.

- TACAN—as briefed.
- Lights—as desired.
- COMM/MSL/RWR volume—as desired.
- ECM controls—as briefed.
- \*UFC/FCNP.
  - Priority—cruise.
  - DATA OPT—HOM.
  - Select desired steerpoint.
  - MODE SEL—depress (if you want the carets on the HUD).
- HUD—intensity as desired.
- Drift Cutout—as desired
  - ATT/FPM—as desired.
  - Contrast/Intensity—as desired.
  - VAH/VVI—as desired.
  - CAS/TAS/GS—CAS.
  - Primary/manual reticle—set as desired.
  - RALT/ALOW—as required.
- Master arm—SIM (ARM for combat or as briefed).
- RWR—on, set as desired.
- Radar.
  - Range scale—as briefed.
  - Radar level/channel/subset—as briefed.
  - Mode—as briefed.
  - AZ SCAN—as briefed.
  - TGT HST—3 or as desired.
  - NB/WB—as briefed.
  - Aq Symbol—at briefed range.
  - EL BAR/EL STROBE—as briefed for altitude coverage.
- \*Master modes—verify programmed.
- SEL JETT—tanks (rack) selected.
- *NOTE:* If tanks are loaded in an actual combat situation, select SEL JETT for your tanks and enter the combat arena with master arm ON to enable immediate jettisoning.
- Chaff/flares—as required.
- Secure voice—as briefed.
- Publications and all loose items stowed/strapped down.
- G-suit—check.
- VTR—as briefed.
- IFF—modes/squawks as briefed.
- MSL—cool.
- SMS—as briefed.

#### 4.6. Principles/Concepts Of Basic Fighter Maneuvers (BFM)

The maneuvers required during a BFM engagement are nothing more than a combination of those learned during AHC. The primary objective of BFM is to maneuver your aircraft into weapons parameters to employ ordnance. To accomplish this you may first need to maneuver so as to keep a bandit from employing ordnance against you. The required maneuvers are not pre-staged to arrive at the end game solution, but are combined as necessary based upon continual reassessment of the situation. The entire process of observing, predicting, and maneuvering is repeated until either a kill or disengagement has been achieved. In order to successfully execute BFM, a pilot must understand his geometric relationship to the target and how it affects his ability to employ his weapons. The spatial relationship of two aircraft can be analyzed from three perspectives: positional geometry, attack geometry, and the weapon envelope.

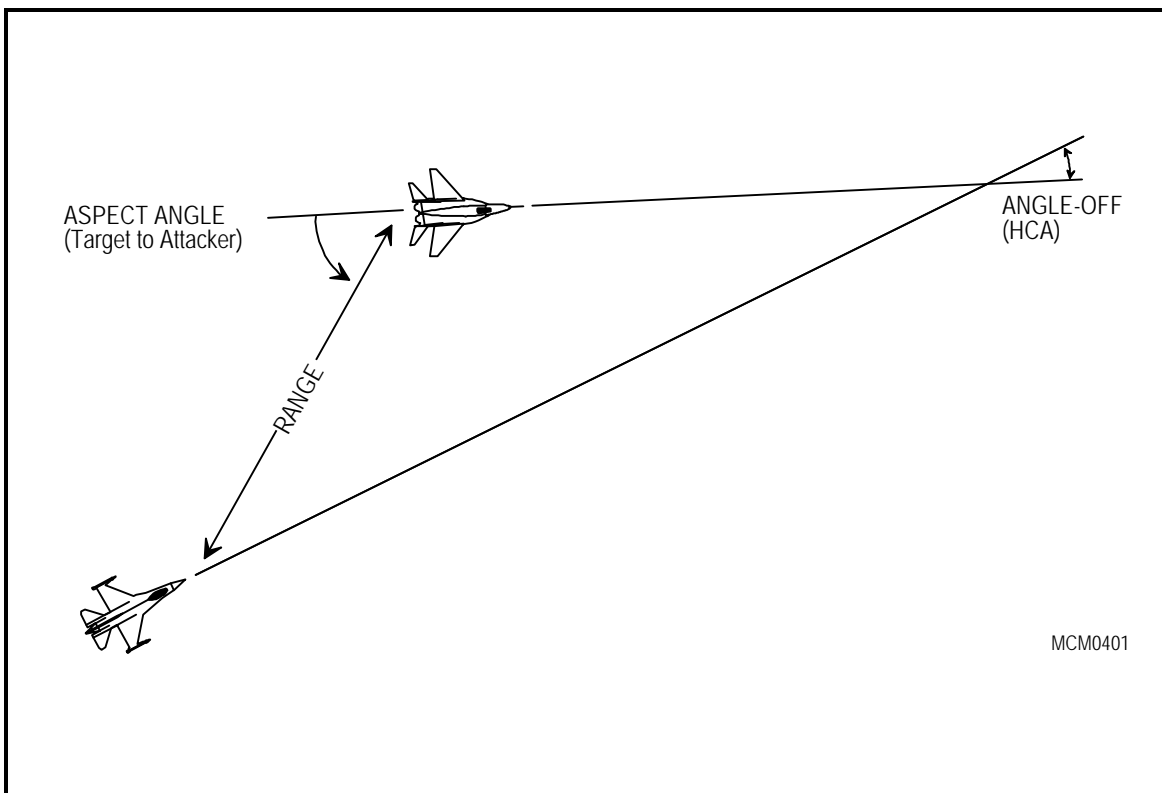
##### 4.6.1. Positional Geometry

When discussing one aircraft's position relative to another, range, aspect angle, and angle-off (heading crossing angle [HCA]) are used to describe angular relationships. These three factors dictate which aircraft enjoys a positional advantage, and how much of an advantage it is (Figure 4.1).

Range is the distance between two aircraft.

Aspect angle describes the relative position of the attacker to the target, without regard to the attacker's heading. It is defined as the angle measured from the tail of the target to the position of the attacker.

Angle-off is primarily concerned with the relative headings of two aircraft. Angle-off is defined as the angular distance between the longitudinal axes of the attacker and the defender. Whenever the attacker is pointing at the defender, the aspect angle and angle-off will be the same.



**Figure 4.1 Angular Relationships**

##### 4.6.2. Attack Geometry

There are three available attack pursuit courses: lead, lag, and pure (Figure 4.2). The attacker's nose position or his lift vector will determine the pursuit course being flown.

If the attacker is in the defender's plane of turn, the position of the attacker's nose determines the pursuit course. With his nose pointed in front of the defender (such as in the case of a gunshot), he is in lead pursuit. If he points behind the defender, he is in lag pursuit. If he points at his adversary, he is in pure pursuit. Note that an initial lead pursuit attacker could be driven into a lag pursuit course if he has insufficient turn rate available to maintain lead (Figure 4.3).

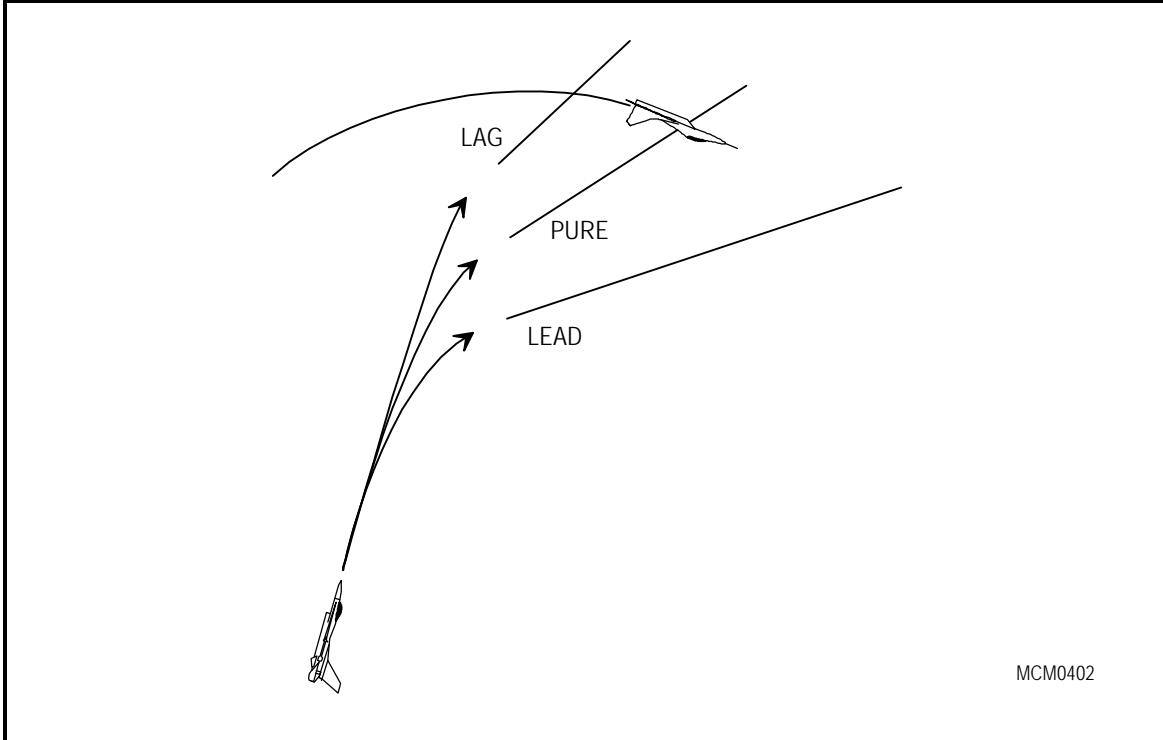


Figure 4.2 Attack Pursuit Courses

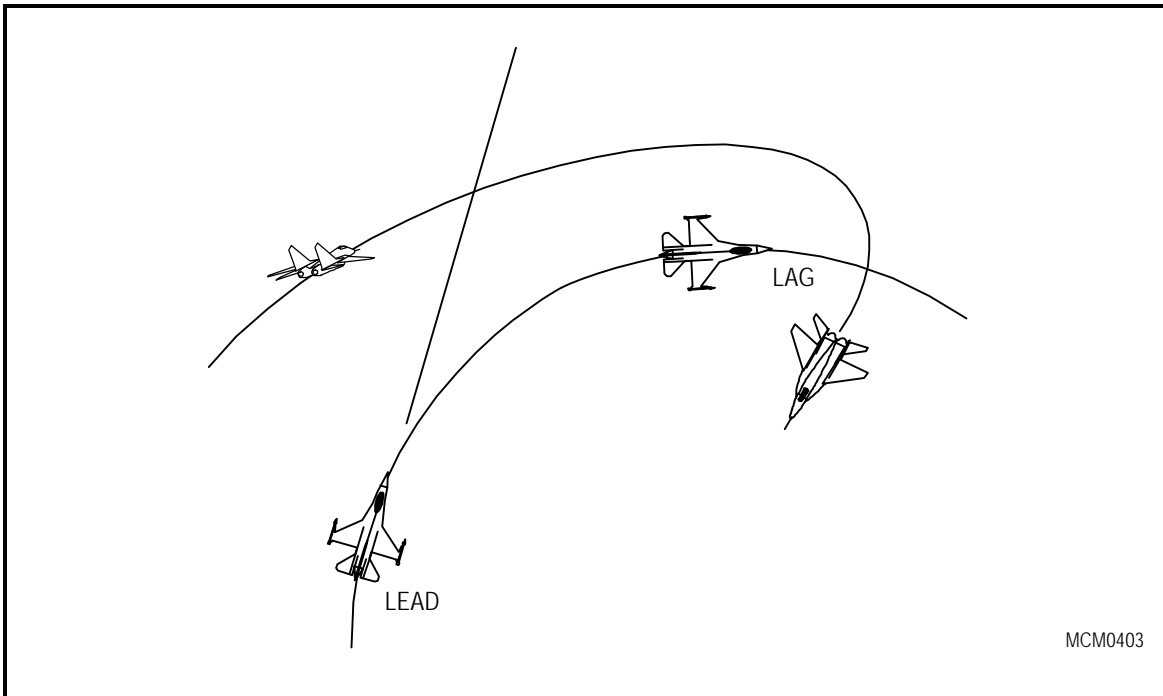
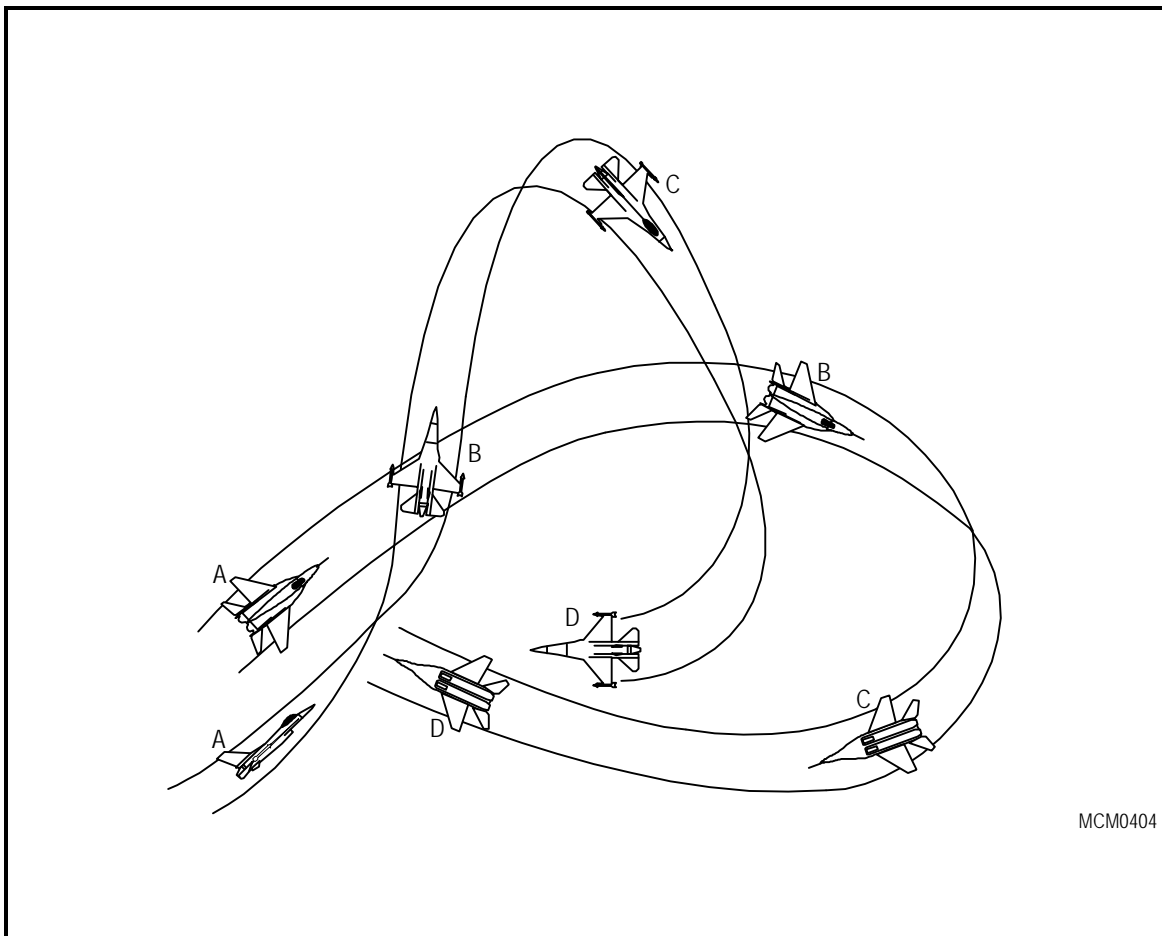


Figure 4.3 Insufficient Turn Rate To Maintain Lead (Resulting in Lag)



When the attacker is out of the defender's plane of turn, his pursuit course is determined by where his present lift vector (the top of his canopy) will position his nose as he enters the defender's plane of turn. For example, if forced out-of-plane by a defender's hard turn, an attacker may have his nose pointed behind the defender during the reposition. After gaining sufficient turning room, if the attacker pulls far enough in front of the bandit to arrive back in-plane with his nose in front on the defender, then he is in lead pursuit. The same holds true for pure or lag pursuit (Figure 4.4). Whether to establish a lead, lag, or pure pursuit course will depend on the relative position of the attacker with respect to the defender's turn circle (TC). The key at point C is to be sure you will enter the defender's turn circle aft of his wingline with the ability to establish an in-plane, lead pursuit course at point D.



**Figure 4.4 Out-of-plane Maneuvering**

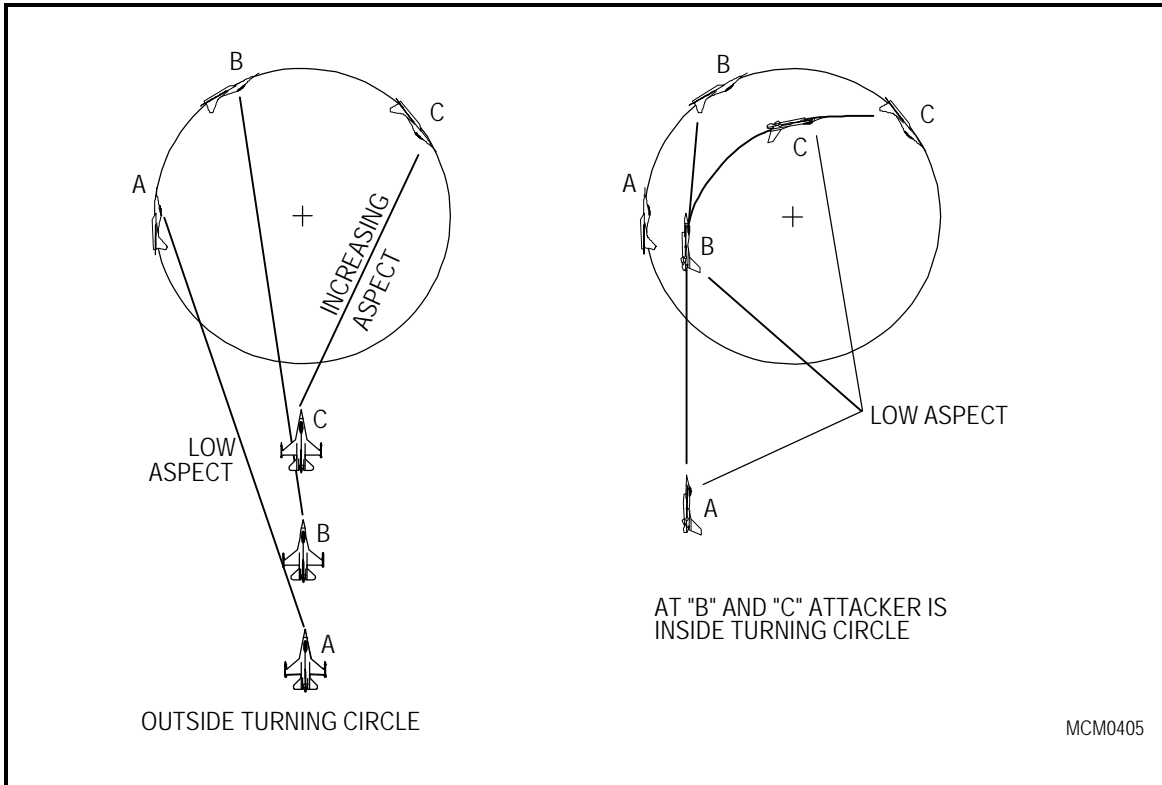
#### 4.6.3. Weapons Envelope

The vulnerable cone of a defender is defined using range, aspect, angle-off, and pursuit course to approximate the employment envelope for a specific type of ordnance. BFM is used when necessary to decrease range, aspect, and angle-off, or until an attacker is within the bandit's vulnerable cone for the ordnance he plans to employ.

#### 4.6.4. Turning Room

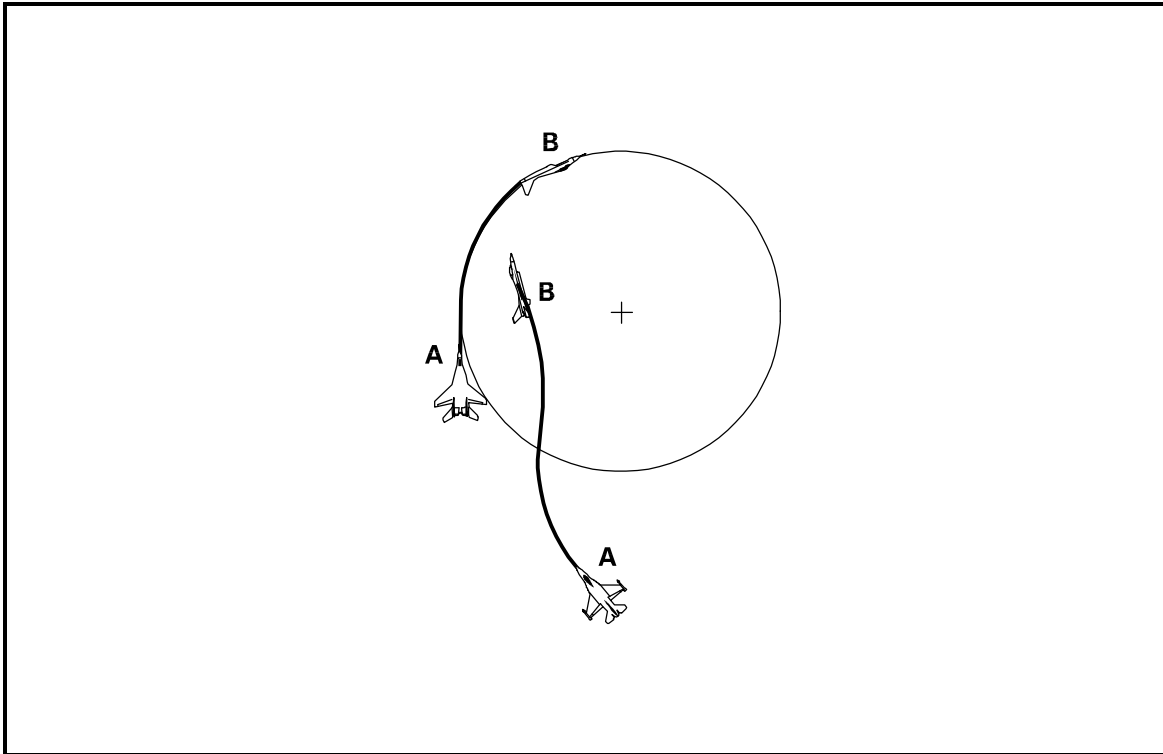
In order to discuss how BFM can solve range, aspect, and angle-off, a concept called turning room and turning circles is used. Turning room is the separation between the two aircraft that can be used to accelerate, to decrease range, or turn and decrease aspect angle and angle-off. A turn circle is defined by aerodynamics and is based on a certain size (the diameter) and how quickly an aircraft can move its nose (turn rate). The determinant of whether an aircraft is (at any instant in time) "inside" or "outside" of a defender's turn circle is the relationship between the attacker's aspect angle and range and the defender's

turn radius/rate. If the defender is turning at a rate that will allow him to continue to increase aspect angle, the attacker is outside the defender's turn circle (Figure 4.5). At the instant the defender can **no longer** increase aspect angle, the attacker has "arrived" inside the defender's turn circle.



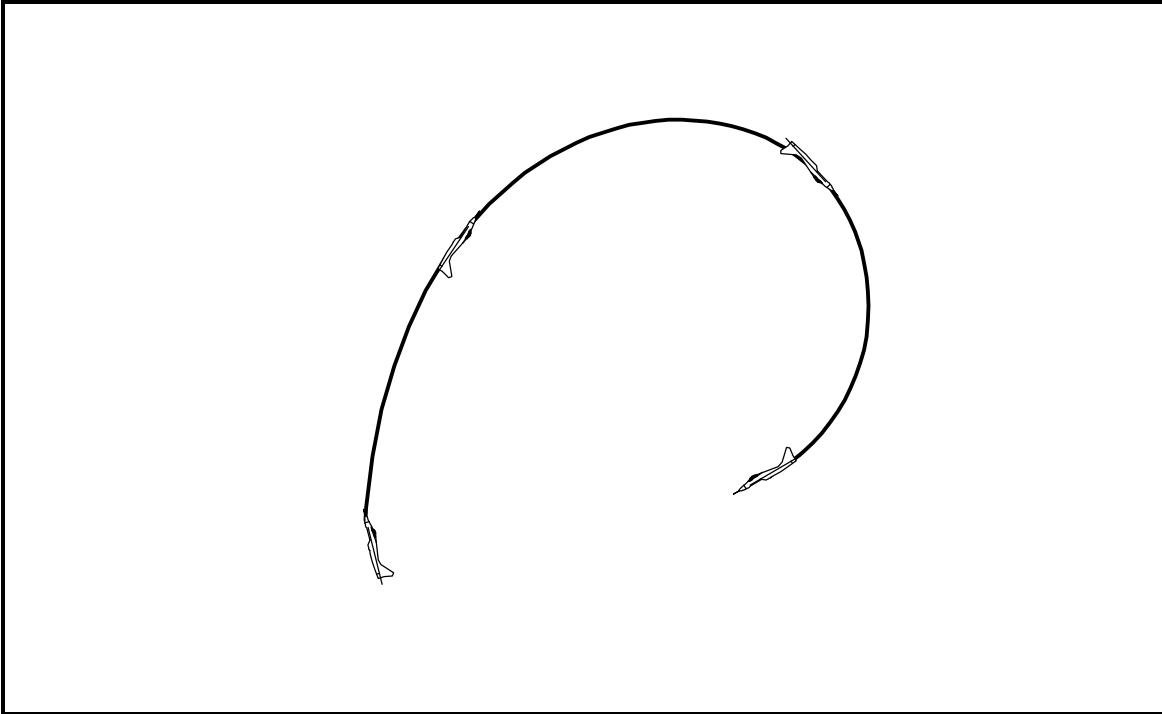
**Figure 4.5 Outside/Inside The Turn Circle**

The attacker's nose position (i.e., lead or lag) relative to the defender's current position and flight path does not strictly determine whether the attacker is inside or outside the defender's turn circle (Figure 4.6).



**Figure 4.6 Lag Pursuit Outside/Inside the Turn Circle**

As the defender bleeds off energy and airspeed, while performing his defensive turn, his turn radius will decrease. His turn rate will also decrease, once the defender slows below his corner velocity (discussed later). This relationship often results in a characteristic "fishhook" appearance to the defender's turn (Figure 4.7). The attacker may **start** inside the turn circle, but end up outside as the defender tightens his turn or slows below corner velocity—depending on the defender's ability to maintain the turn **rate** and how the attacker maneuvers. It is very important to note that turning room can be acquired in either the lateral or vertical planes or a combination of both. Another important note is turning room can be used by either aircraft.



**Figure 4.7 Fishhook Turn**

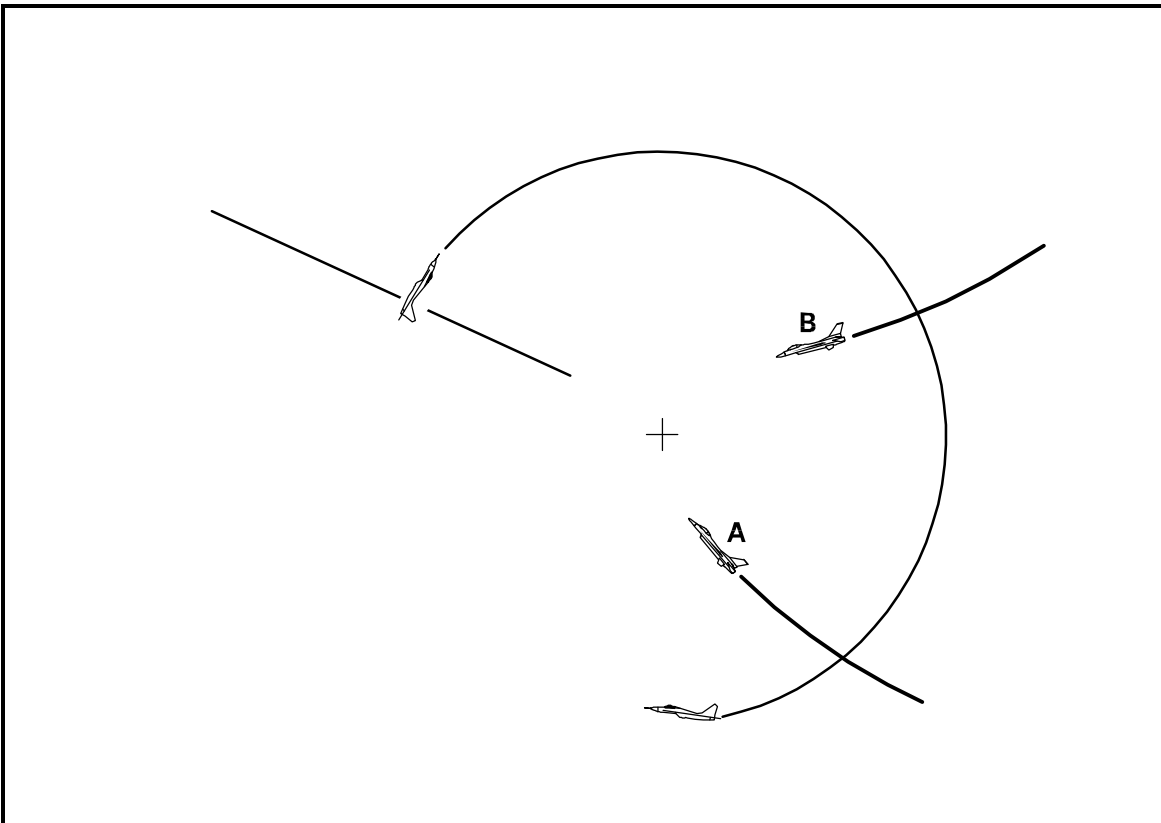
Lateral turning room is **in** the bandit's plane of motion. The bandit's turn direction (into or away from the attacker) will affect how much turning room is available. If the attacker is inside the bandit's turn circle, he must have a turn rate and radius capability that will allow him to "make the corner" the bandit presents. The disadvantage of lateral turning room inside the bandit's turn is that it frequently requires high energy bleed rates to generate the turn rate required to make the corner and stay in the bandit's plane of motion. If the defender turns away from the attacker, turning room increases. If the attacker is on the belly-side of the defender's turn, part of his geometry problem is being solved initially since the bandit is rotating his vulnerable cone towards the attacker.

Vertical turning room is acquired **out** of the bandit's plane of turn. If the bandit is in a vertical turn, this turning room may be located in a horizontal plane. If the bandit is in the horizontal, then turning room will be available either above or below his plane of motion. Range and closure will govern the amount of turning room that can be generated. Energy can be gained while maneuvering for turning room below. If the pilot elects to go for turning room above the bandit, he must have the airspeed to drive above the bandit while retaining sufficient energy to continue his attack. The attacker must remember his turning room is also the bandit's turning room. If the attacker does not have the energy to use the turning room, then he must deny the bandit the use of it. Turning room required is based on an aircraft's turn performance and turn geometry; therefore, a more maneuverable aircraft will not require as much turning room as a less maneuverable one.

Turning room is normally established as you transition inside the defender's turn circle. Trying to establish vertical or lateral turning room outside the turn circle can result in the attacker becoming the defender. The same thing can happen while trying to build turning room starting from inside a defender's turn circle if you subsequently maneuver outside of his turn circle. The bandit **may** have the capability to force a role reversal similar to an overshoot.

The attacker can recognize that he is inside or will transition inside the defender's turn circle by observing the defender. If the defender's present rate of turn will not bring his nose on the attacker **and** the attacker sees line of sight (LOS) movement by the defender, then the attacker is inside, or will transition inside, the defender's turn circle (Figure 4.8). Another visual cue is the defender's **aspect angle remains constant or begins to decrease**.

As you can see from Figure 4.8, both attackers A and B begin outside the bandit's turn circle and transition inside. The position relative to the defender's 3/9 line has nothing to do with being inside or outside the defender's turn circle. The defender's ability to point at the attacker will determine whether the attacker is inside, will transition inside, or is outside of the turning circle. There are a myriad of things that determine the aspect and angle-off when transitioning into the defender's turn circle, i.e., range,  $V_C$ , defender's turn capability, and the aspect and angle-off when beginning the attack. The aspect and angle-off the attacker perceives at the transition will determine the initial pursuit course he elects. The actual aspect and angle-off as well as the turning room and relative energy states will dictate weapons envelope and the degree of BFM necessary to achieve a kill.



**Figure 4.8 Recognizing Turn Circle**

#### 4.6.5. Mechanics of BFM

This section will examine the three basic principles of BFM: roll, turn, and acceleration.

##### 4.6.5.1. Roll

Roll allows the pilot to position his lift vector, thus determining the plane of motion in which he will turn. At high speed and low AOA, the F-16 has a very high roll-rate capability. However, as the airspeed slows and AOA builds, the roll performance begins to degrade. At slow speed, in order to roll more rapidly, the AOA must be reduced prior to initiating the roll. It should also be noted that the slower the airspeed, the longer it will take to command a reduction of AOA. This factor becomes very important in slow speed lift vector positioning such as might be required to defeat a gunshot.

An important aspect of roll is the ability to slow the forward velocity of the aircraft. If G is maintained and a roll is initiated, a spiral is made in the flight path, thereby increasing the "through the air" distance the aircraft flies to arrive at any selected point.

An additional benefit of roll is the ability to position the bandit so the pilot can maintain a tally. This is especially useful with an aft quadrant bandit where a simple roll to maintain line of sight (LOS) is preferable to energy depleting "kickouts."

#### 4.6.5.2. Turn

Turn radius determines the size of the turn circle. This radius is based on the aircraft's TAS and radial G. The size of the circle and the relative turn rate capability of the two aircraft will determine how well the pilot can solve the angular problems the defender presents. The objective is to work to where available G will allow the attacker to point his nose at the defender to achieve a missile or gun shot with an acceptable specific power ( $P_S$ ) bleed-off. How well an aircraft can turn is a function of the turn rate and radius it generates.

Radius defines the size of an aircraft's turn or its turning "circle." In the F-16, turn radius at max AOA/G is relatively constant over an airspeed range of 170 knots calibrated airspeed (KCAS) up to 330 KCAS. Above 330 KCAS, turn radius increases slightly as max G is obtained (440 KCAS). Above 440 KCAS, turn radius increases dramatically. Because of the F-16 flight control system, the F-16 does not have a true corner velocity. It has a "corner plateau" which is an airspeed range of 330 - 440 KCAS that produces a good turn rate based on available G. (see Figure 4.9). Offensively, sustained operations are not possible **in the same plane** against a defender with a smaller turn circle (radius) assuming similar turn rates without inviting an overshoot/reversal situation (Figure 4.10).

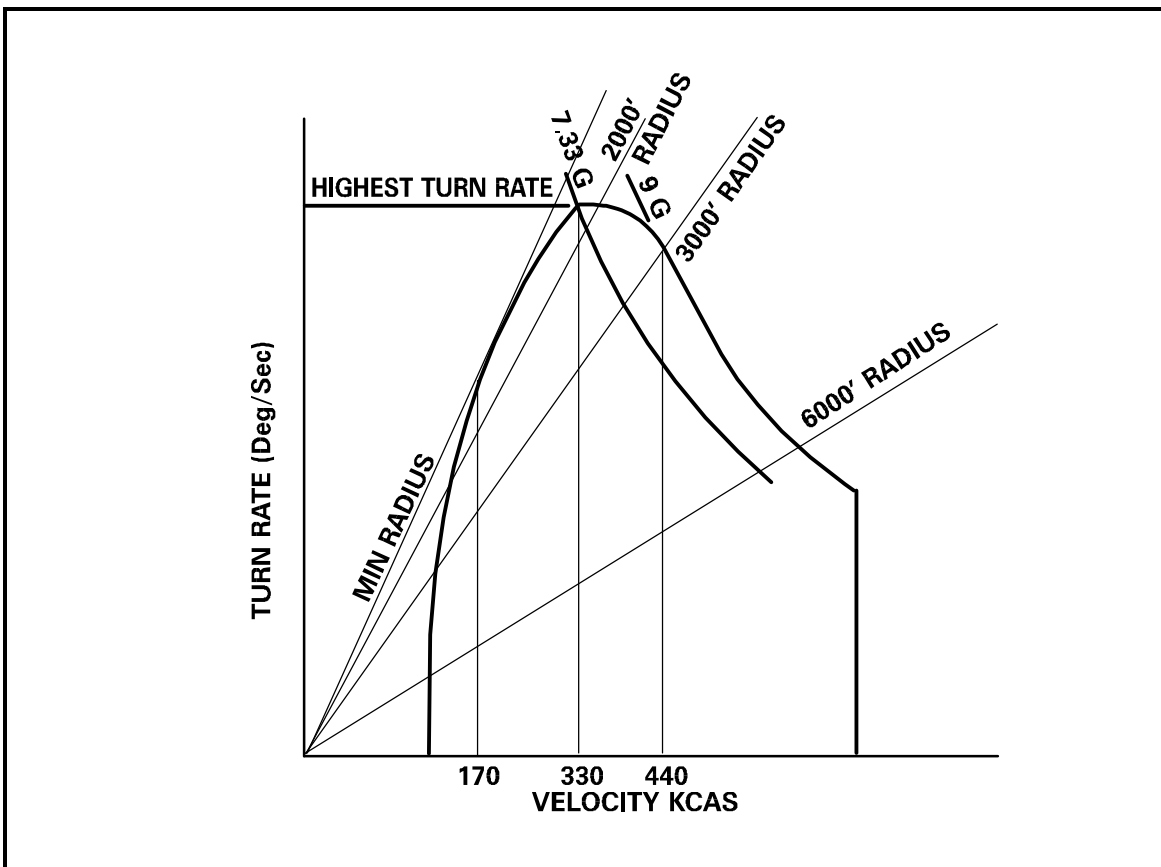
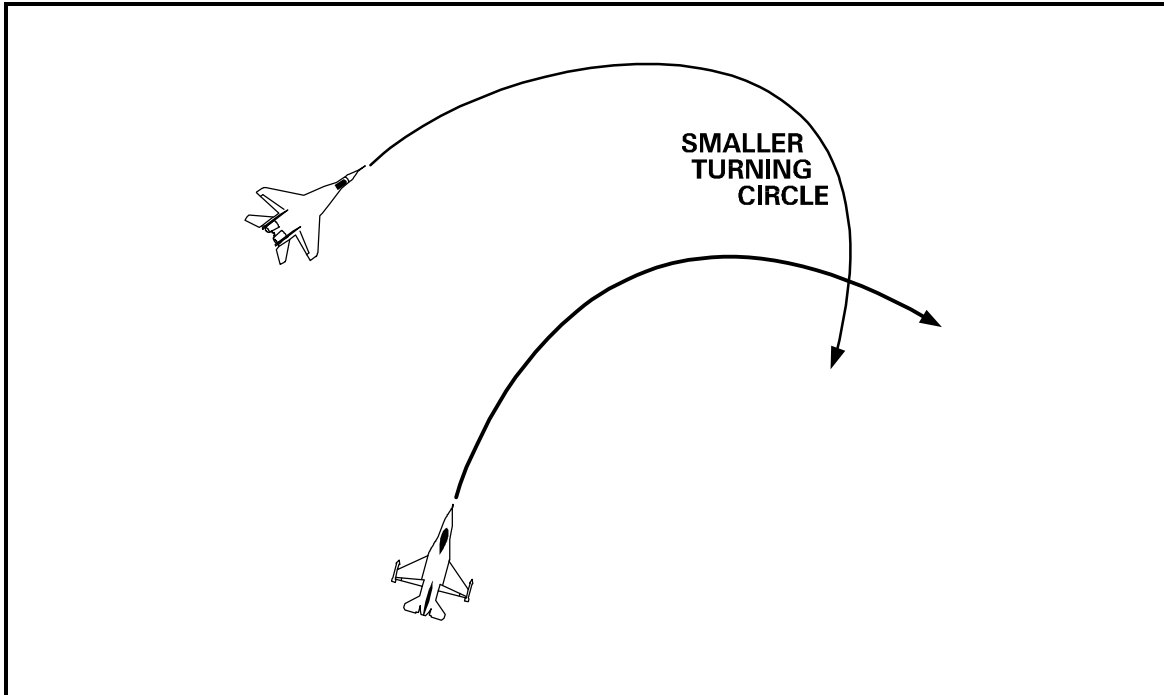
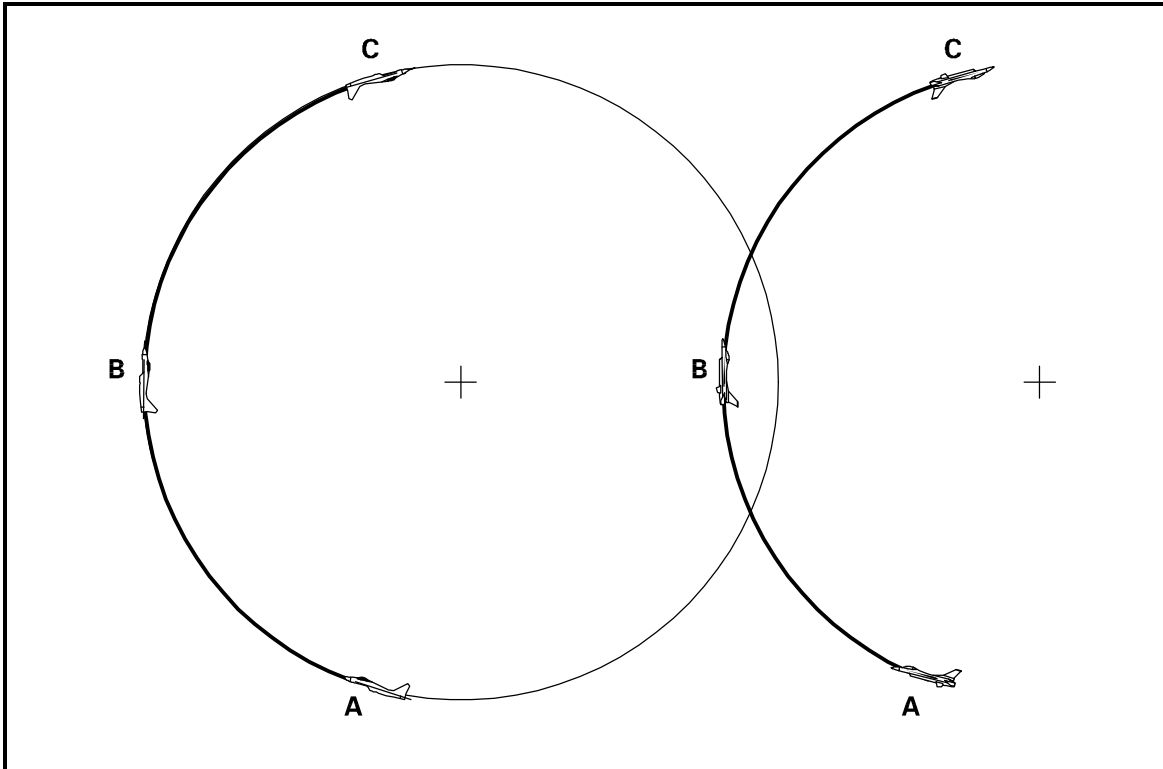


Figure 4.9 Turn Rate and Velocity



**Figure 4.10 Overshoot/Reversal Situation**

Even if the attacker has the identical turn rate/radius capability as the defender (1v1 similar), the attacker is unable to sustain operations **in the same plane** to the degree the center of the two turn circles are offset. In a gross example, if the attacker is outside the defender's turn circle and immediately turns, instead of accelerating into the defender's turn circle, roles will be reversed after 180° of turn (Figure 4.11).

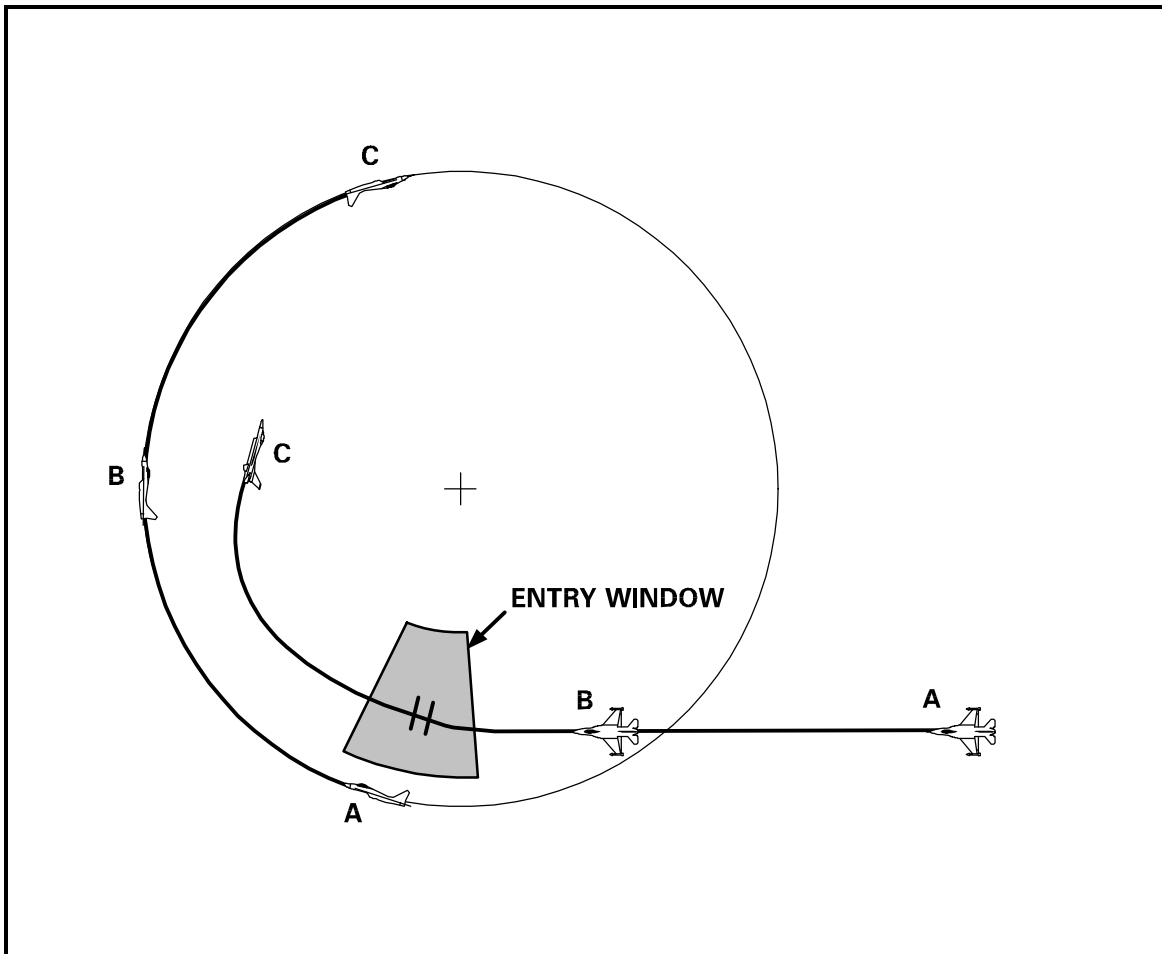


**Figure 4.11 Turning on Offset Turn Circles**

The attacker's solution to the situation described above (outside defender's turn circle) is to maneuver into the defender's turn circle, aiming toward an "entry window" (Figure 4.12). This involves initially pointing to lag. For example, at point B in Figure 4.12 the attacker has just entered the turn circle and has his nose in lag. Upon reaching the "entry window," to close on the defender the attacker may need an out-of-plane maneuver (discussed later) to avoid overshooting, followed by a pull back towards lead pursuit. The ability to enter the defender's turn circle and control geometric closure by initially pointing to lag is an important concept in BFM.

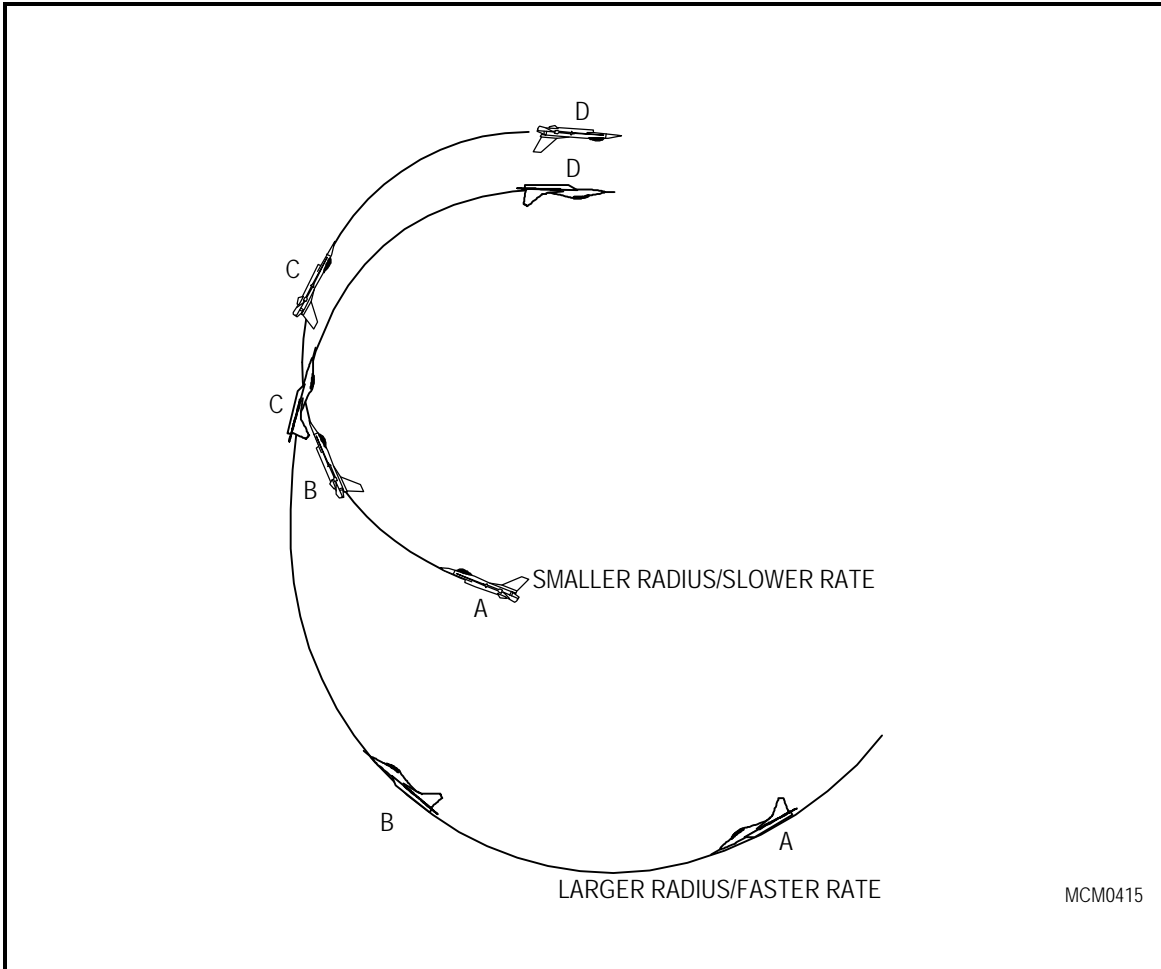
A defender wants to decrease his turning circle as much as possible. This is because a superior turning aircraft cannot use his better turn capability until he is inside a defender's turn circle. An earlier turn would merely effect an "in-place" turn (Figure 4.11).





**Figure 4.12 Lag to Entry Window**

Rate is needed to achieve weapons parameters or defeat attacks. The F-16's turn rate increases very rapidly from slow speed up to 330 KCAS, at which point the rate is the highest (Figure 4.9). Rate allows the attacker to match or exceed the turn rate of his adversary and establish lead for a gunshot. The attacker needs a turn rate advantage that will allow him to pull his nose onto the bandit to employ the AIM-9 or point to lead pursuit for a gun shot. It is important to note an attacker with a higher **sustained** turn **rate** can maintain a positional advantage against a defender with a **smaller** turn **radius** but reduced rate (Figure 4.13). In order to employ the AIM-9, he must have a turn rate that will allow him to keep his nose within approximately  $30^\circ$  of the bandit for tone acquisition and missile launch. The ability to maintain a high **sustained** turn **rate** (corner plateau, 330 - 440 KCAS in the F-16) while the defender sacrifices sustained rate for a tighter turn is another key concept in understanding BFM. In this sense, a turn rate advantage is more tactically significant than a smaller turn radius.



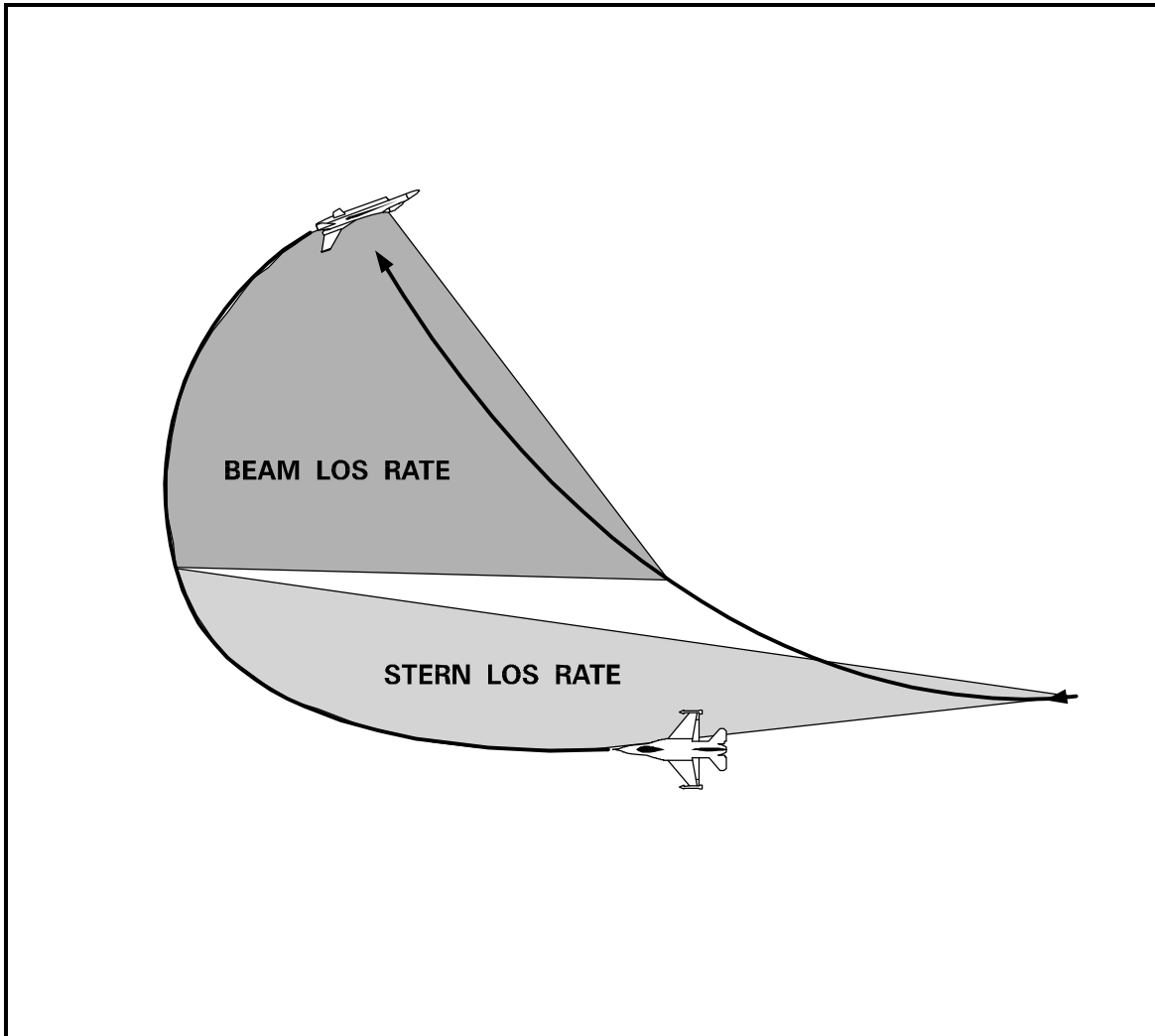
**Figure 4.13 Turning at Different Rates**

Rate is also used to defeat threats. A defender can use rate to drive an attacker into a lag position and thereby deny him a missile shot or a gunshot opportunity. In close, if the attacker has already established lead, the defender can roll and turn out of the bandit's plane of turn to spoil his gunshot solution. A missile fired in the aft quadrant can be defeated by rotating the aircraft towards  $90^\circ$  aspect angle with regard to the missile. This will generate the maximum line-of-sight (LOS) problem for the missile and hopefully exceed its gimbal tracking capability or its turn capability. Slowing below corner to decrease turn radius is not advisable. As already discussed, a smaller turn radius will enhance the overshoot probability of the missile, but the missile will still kill if the overshoot occurs within fuze functioning distance of the target. A higher turn rate, not a small turn radius, is necessary for a successful missile defense. The F-16 also turns better with afterburner (AB). AB gives a better turn capability because it allows the pilot to sustain airspeed and thereby sustain a higher turn rate (assuming near corner velocity). In addition, maneuvering at higher AOAs results in a greater portion of the aircraft's thrust vector to be pointed toward the center of the turn, which also helps the F-16 maintain a smaller turn radius and greater turn rate. To achieve the highest turn rate possible, slow or accelerate towards corner velocity speed range (330 to 440 KCAS) as quickly as possible and turn hard to generate maximum angles in the shortest time. The maximum LOS problem for a missile occurs at  $90^\circ$  of aspect angle (Figure 4.14). For further discussion on infrared missile defense, refer to MCM 3-1, Volume 5.

It is important to remember that although a turn initiated on the limiter may give you your best initial turn rate, you may not be able to sustain it. Monitor your airspeed. If it falls below 330 KCAS, you will have to relax G (or descend) in order to maintain best sustained turn rate airspeed. Remember, speed is life. Unless you have a reason to be slow, don't get there.

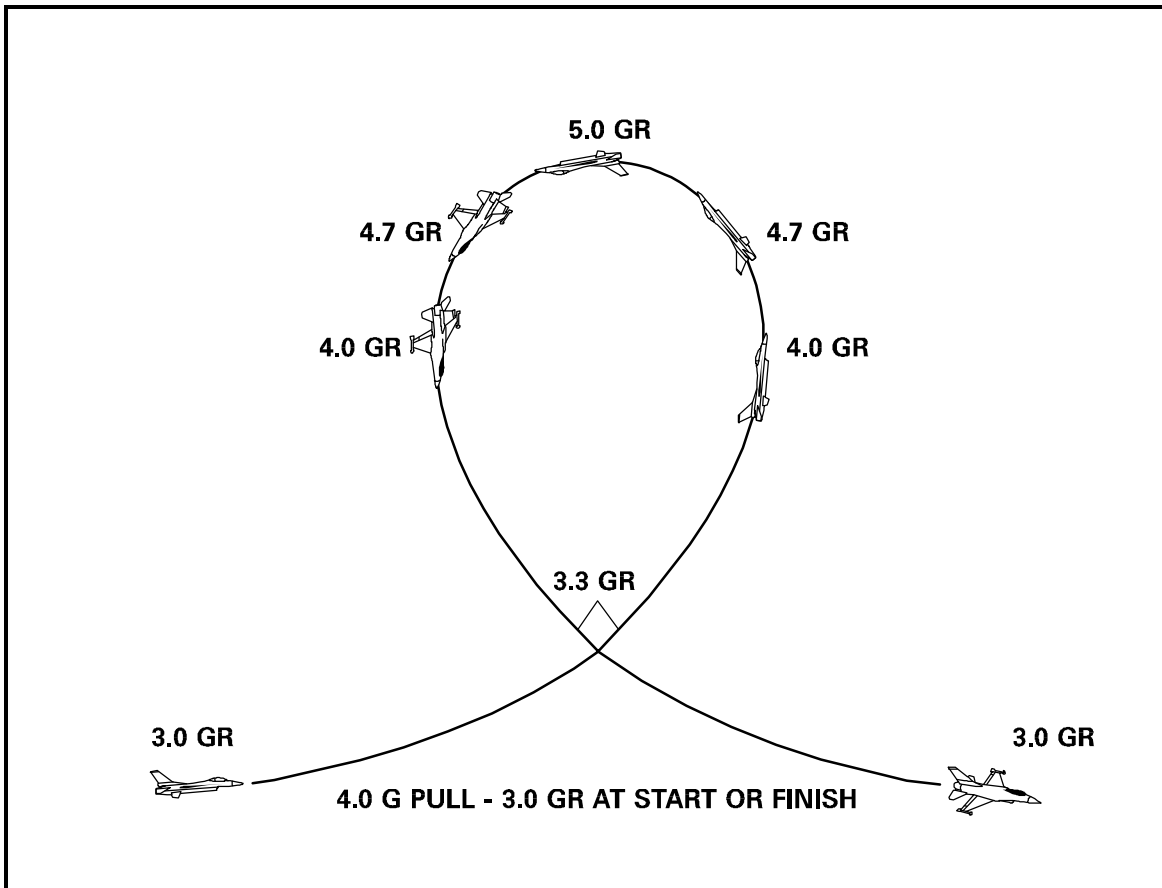
As a rule of thumb, these are some reasons you may find yourself slow (hopefully not for long) due to trading energy for turn rate:

- Solving those last few angles during BFM in order to employ ordnance.
- To salvage a bad situation. To avoid becoming defensive or losing 3/9 advantage.
- Defeating enemy ordnance.
- You discover you're a student in the Weapons School.



**Figure 4.14 Missile LOS Rates**

When turning in the vertical, rate and radius are affected by the earth's pull (gravity). Any time the aircraft's lift vector is above the horizon, turn rate is decreased and turn radius is increased. If a loop were performed at a constant (cockpit) G, the flight path would be characterized by an "egg" shape (Figure 4.15). A 4 G loop would result in effective radial G ( $G_R$ ) loading as indicated in the figure. From the cockpit perspective, a 4 G turn at the top of a loop "turns like" a 5 G horizontal turn.



**Figure 4.15 Vertical Turning**

If a pilot can utilize a downhill turn at key points in a BFM engagement, his relative turning performance will be better than his adversary's. This fact allows an attacker, flying proper BFM and starting from inside the defender's turn circle, to maintain a positional advantage. When a vertical (downhill) turn is used to complete a counter turn, the attacker can **more than make up** for turn performance lost while performing the counter turn. The attacker can use superior turning performance to solve angle-off problems and choose the desired pursuit curve to fly to weapons employment parameters. In practice, the counter turn and/or the initial part of the reversal is often accompanied by a **slight** climb that allows the attacker to set up the downhill part of his maneuver and not be required to fly excessively below the defender's plane of motion while turning to solve angle-off and pursuit curve problems. This **slight** climb (while turning) and slice turn sequence results in a maneuver commonly called a "Hi Yo-Yo" usually followed by a "Low Yo-Yo." Another important concept of vertical turning is "optimizing" turn rate and energy (airspeed) expenditure. Utilizing maximum available G while entering a purely vertical turn (loop) excessively bleeds energy while "working against" gravity. Generally, a lower G vertical turn is more efficient at the beginning and end of a loop, while maximum G (maximum rate) vertical turns can be best employed when working "with" gravity—from nose pointing straight up until nose pointing straight down. Flying an optimum loop—using 3 - 4 G's at beginning and end, and maximum G available while flying over the top—maximizes vertical maneuvering potential. Maximum turn rate at the bottom of vertical turns should normally be used only to force a trailing aircraft's nose into lag and to cause the trailer to overshoot in the vertical (Figure 4.16). Additionally, vertical turns performed in the "pure" vertical (i.e., no lateral or horizontal component) deny a trailing (similar) aircraft, at a lower energy state, the capability to counter the result of the energy differential by performing an oblique or horizontal turn (Figure 4.17).

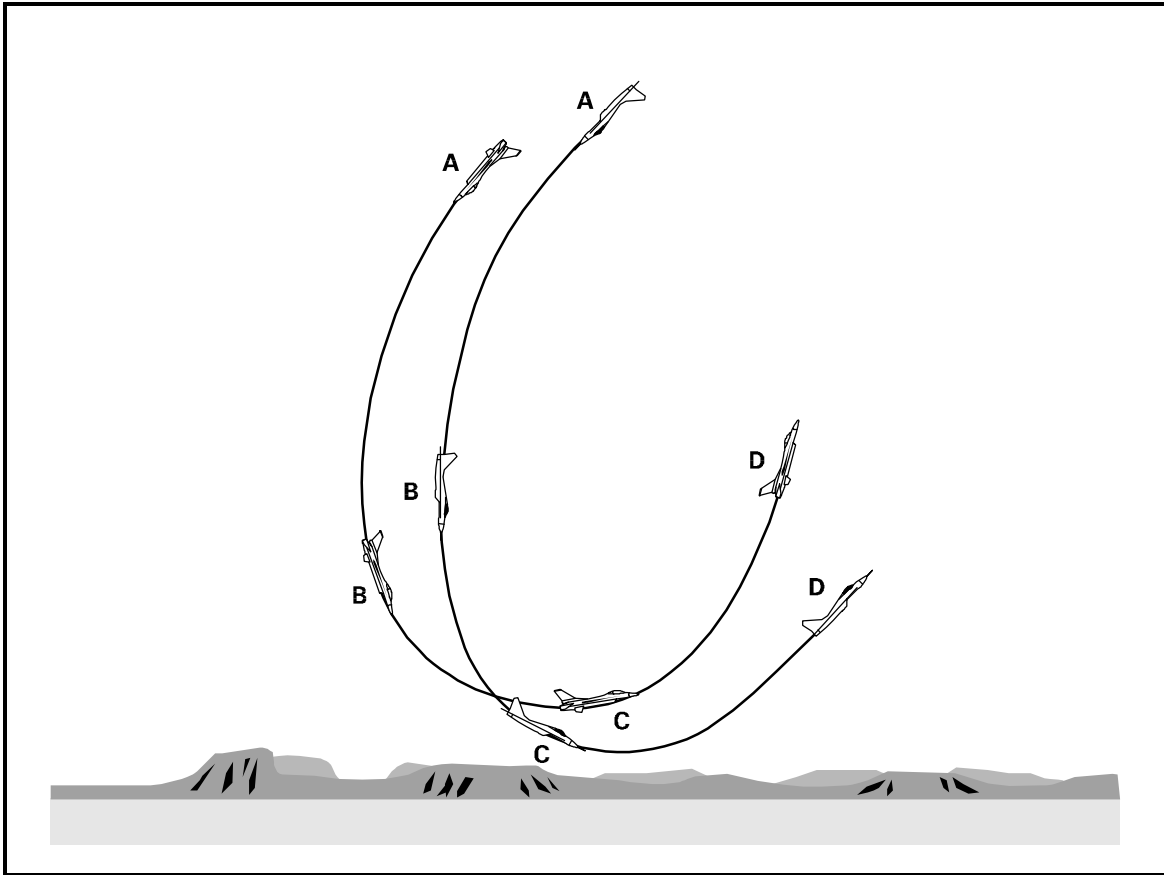


Figure 4.16 Vertical Overshoot

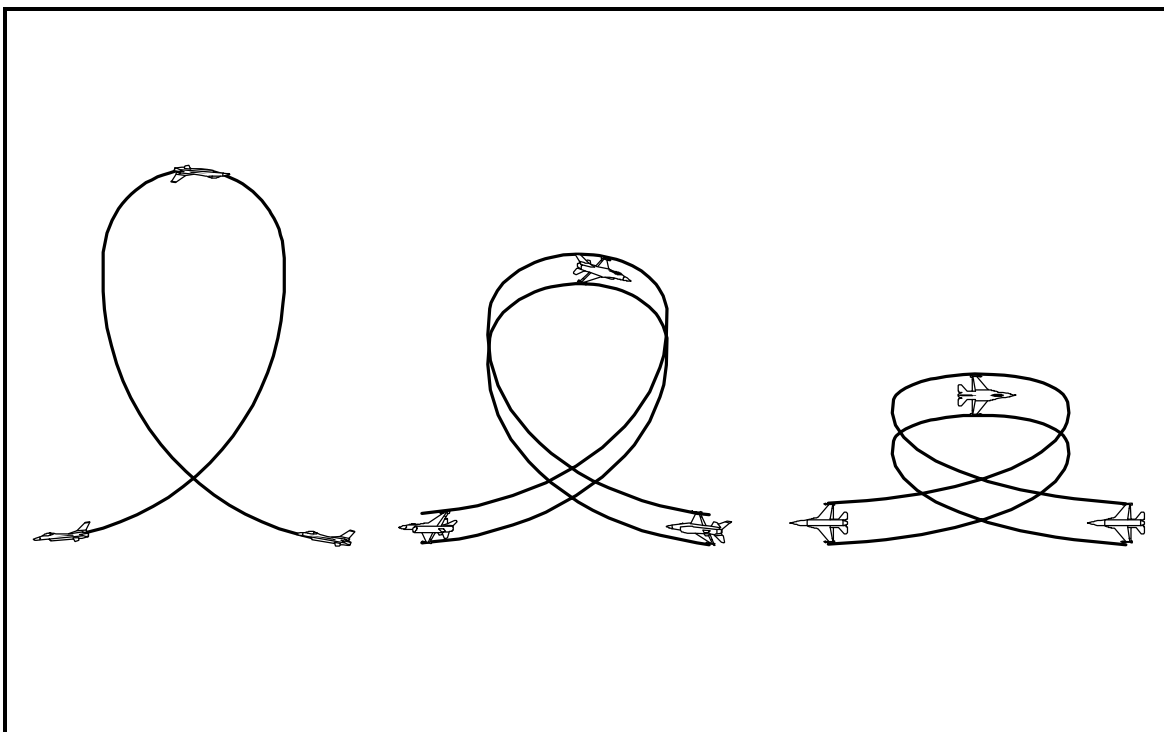


Figure 4.17 Vertical Versus Oblique Turning

#### 4.6.5.3. Acceleration

The three primary factors affecting acceleration are altitude, attitude, and airspeed.

##### 4.6.5.3.1. Effects of Altitude

The lower the density altitude the more effective the acceleration will be because of increased thrust.

##### 4.6.5.3.2. Effects of Attitude

The total energy gained during an acceleration maneuver is a trade off between airspeed gained and altitude lost. Aircraft attitude determines the effect of gravity on an acceleration maneuver. If the aircraft velocity vector is above the horizon, acceleration effectiveness is reduced. If the aircraft velocity vector is below the horizon, effectiveness is enhanced. Aircraft G loading effects induced drag and acceleration effectiveness. The fastest airspeed gain occurs in an unloaded (0 G), nose-low acceleration. The end result of this maneuver is a large altitude loss and very nose-low attitude that may be unacceptable in an aerial engagement. If altitude is a factor, select AB and fly a 0.7 to 0.9 G, slightly nose-low extension maneuver. While airspeed gain will not be as rapid as at 0 G, altitude loss is minimized and you will not bury the nose. The point to remember is that the closer you are to 0 G, the faster you will accelerate, but you will bury the nose more and lose more altitude. This is especially important in an attempt to separate from an opponent, because if the nose is buried in a very nose-low, unloaded acceleration, the resulting high G pullout may provide the bandit a chance to affect a lead pursuit course or "arc you" during the ground avoidance turn. In any case, however, attempt to get the nose below the horizon before establishing the "optimum G" for an acceleration. Rarely will a nose-high acceleration be effective.

##### 4.6.5.3.3. Effects of Airspeed

Acceleration is a trade off between thrust and drag. Thrust increases at a greater rate than parasite drag with velocity increases over the speed range of 100 KCAS to 450 KCAS (or 0.95 mach whichever comes first) due to the ram air effects on the engine. Above 450 KCAS, acceleration rates decrease as drag becomes dominant (both parasite drag and compressibility drag). As a rule of thumb, the best acceleration rates occur in the speed range from 300 to 400 KCAS.

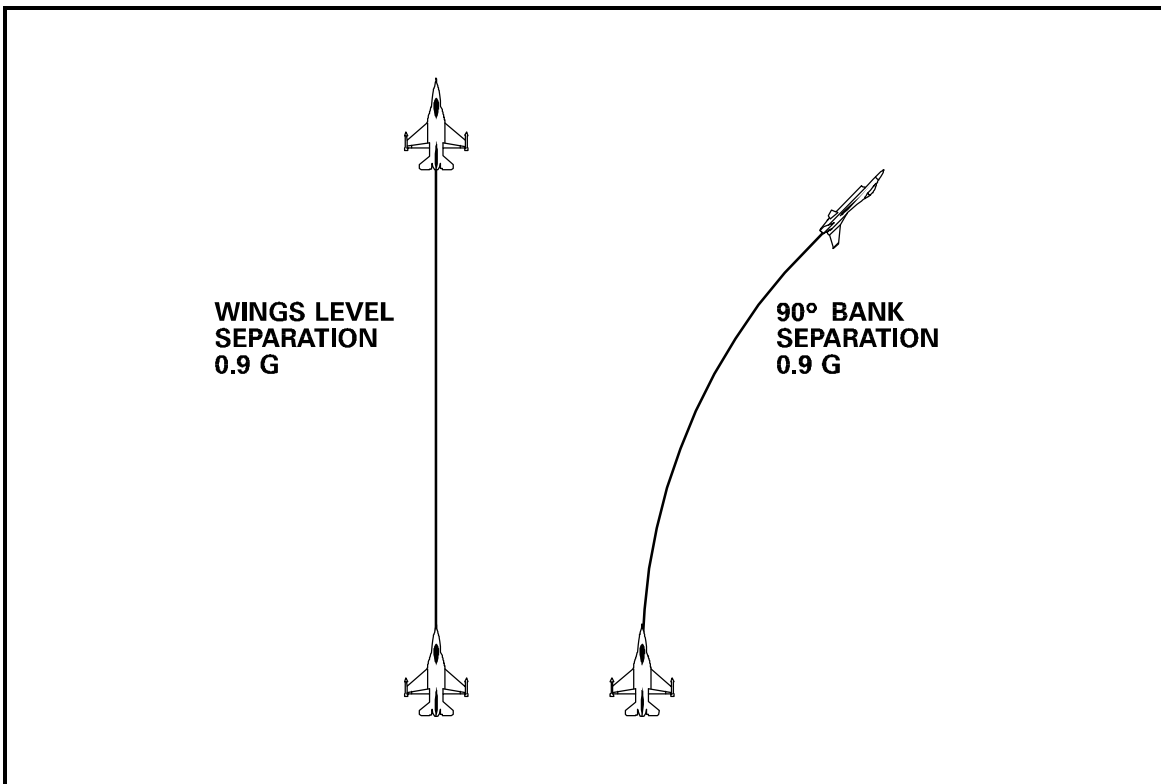
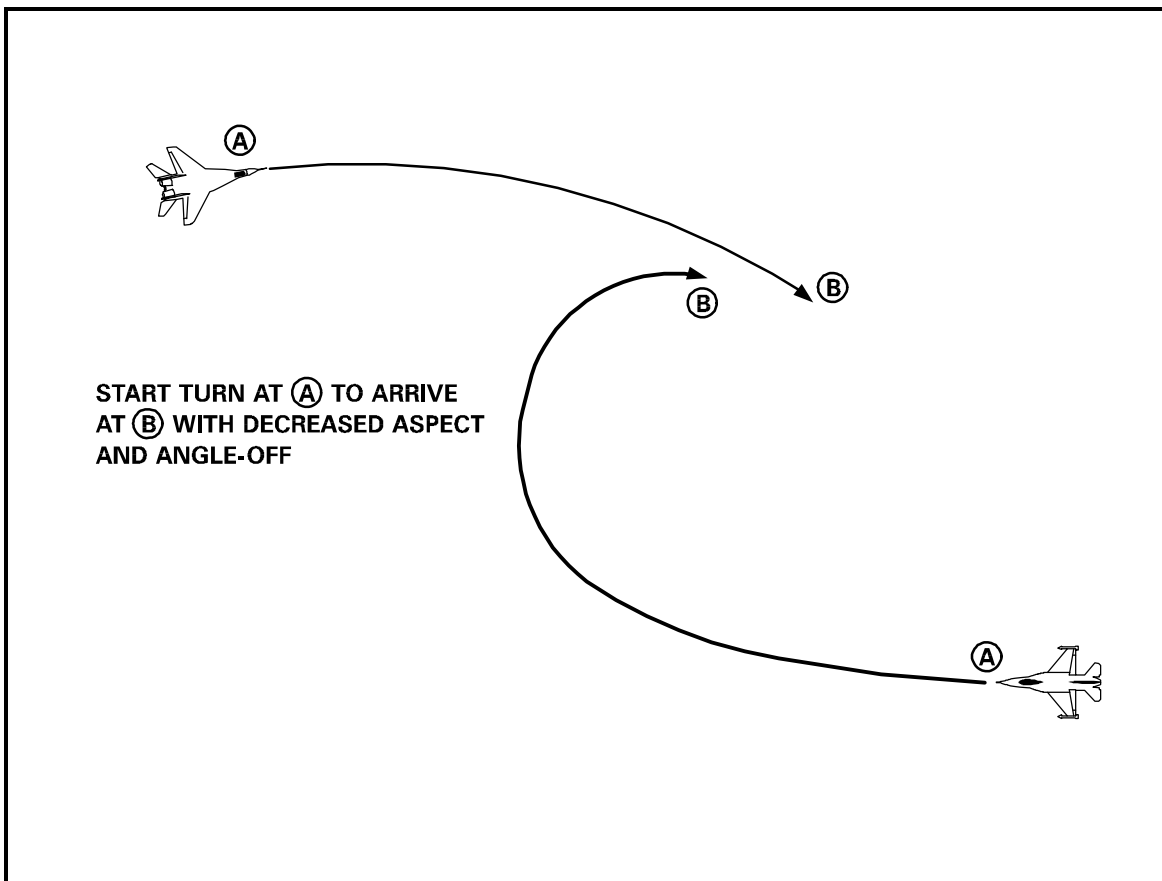


Figure 4.18 Effect of Bank Angle on Separation

Often, the purpose of an acceleration maneuver is to separate from an adversary—get beyond his maximum missile range. In this case, the object is to fly a straight line over the ground to prevent the adversary from arcing. As bank angle increases from wings level to 90°, the corresponding "optimum" acceleration G decreases (to maintain a straight line flight path). At 0.9 G and 90° of bank, the aircraft is turning laterally as though it was in a 30° (rejoin) level turn (Figure 4.18). To reduce the potential for arcing, reduce G to 0 when approaching 90° of bank.

#### 4.6.6. Lead Turns

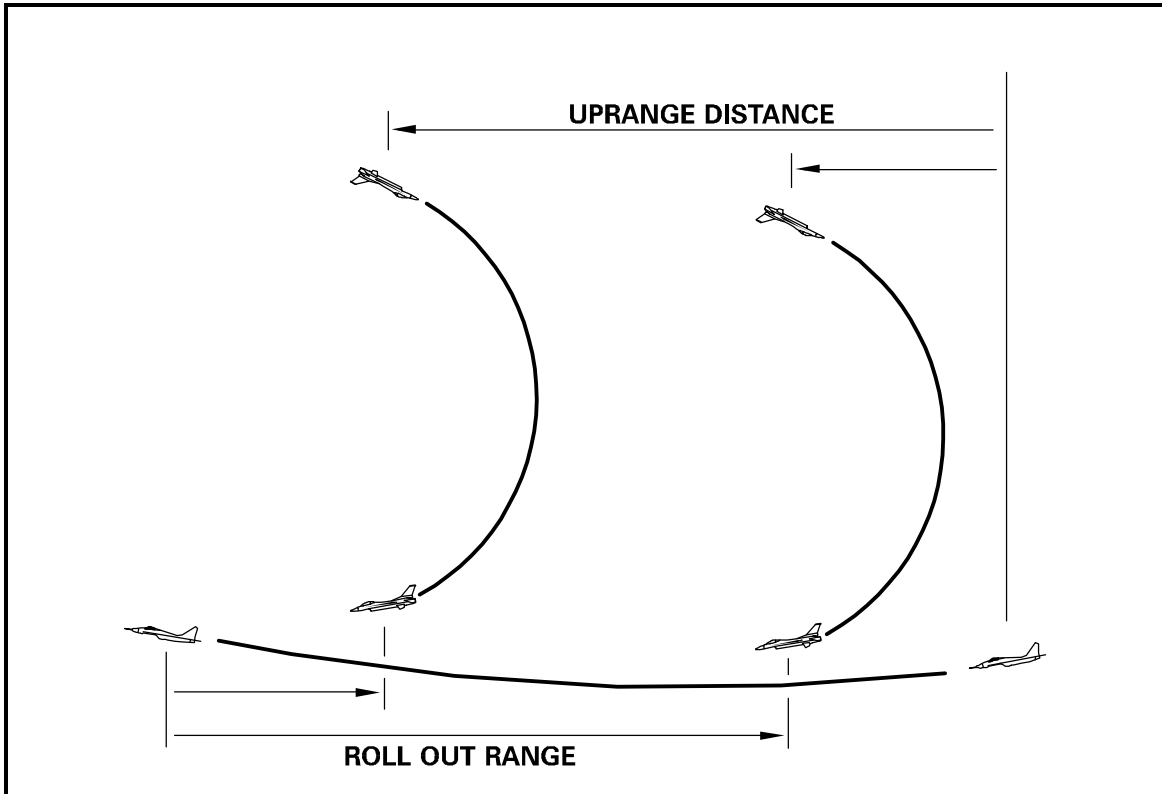
A lead turn is the most efficient BFM maneuver. A lead turn is nothing more than an attempt to decrease angle-off prior to passing the opponent's 3/9 line. It can be done in any plane (horizontal, vertical or combination of both). The classic lead turn is accomplished by the pilot offsetting his flight path one turn diameter from his adversary. He observes where his opponent is going and predicts where he will be at some point in the future. He then initiates a turn to arrive at a point in space with reduced aspect and angle-off (Figure 4.19). Plan to lead turn to a position about one turn radius behind the defender.



**Figure 4.19 Lead Turn**

The size of your turn circle, turn rate capability, and the defender's airspeed will determine the point you initiate the lead turn. Considerable judgment is required to properly initiate and execute a lead turn so as to arrive within the intended weapons parameters. It is important to stress that a lead turn requires the initiation of the turn forward of the defender's 3/9 line. (Remember turning room for one is also turning room for the other and the tighter turning fighter has the advantage.) The point to start the turn is based on the question "Can I make that corner?" When the answer is "Yes," start the turn. You may also notice the proper lead point as where LOS movement increases. The lead turn opportunity normally begins inside the bandit's turn circle, and just as the LOS rate changes as you enter a bandit's circle from a 9,000 foot perch setup, the LOS rate will increase in a high aspect pass as you enter the bandit's turn circle, except that the change in LOS rate is not as apparent. This LOS rate is that caused by the relative

motion between the fighter and the bandit, not the apparent LOS rate caused by fighter maneuvering. During the turn, G should be adjusted as required to keep the adversary moving slightly forward along the horizon (horizontal turn). The objective is to roll out **behind** the adversary. The more turning room acquired, the longer the range for lead turn initiation and the lower the G-loading required to complete the maneuver. Conversely, if the maneuver is initiated at short range with little or no offset, a high-G turn will be required to complete the maneuver. The uprange distance at which a lead turn is initiated will govern the roll-out range at the target's six (Figure 4.20). Lead turns against a target that maneuvers prior to passing your 3/9 line will not produce a dead six position, but should still result in some turn advantage. Bandit LOS rate aft on the canopy and aspect less than 180 are the visual cues for a lead turn and work for both horizontal and vertical conversions. These cues only take into account positional advantages, not energy differences. Once LOS movement becomes apparent, put the lift vector in lead of the bandit and use enough G to keep the turn rate as close to the LOS rate as possible, or allow the LOS to drift slightly forward. If you pull to exceed the bandit's LOS rate (bandit moving forward on the canopy) you may be turning belly up to the bandit and risk becoming defensive, unless the conditions permit a no-respect lead turn. A bandit who turns to pass 180 aspect with you will not allow a lead turn. If you were to try to lead turn a bandit 180° out prior to passing him, and without seeing the proper cues, you could allow yourself to be lead turned unless you are in a no respect lead turn situation.



**Figure 4.20 Lead Turn to Weapons Parameters**

A lead turn may be attempted without turning room simply by initiating a turn prior to passing the opponent's 3/9 line. This is commonly referred to as a "no respect" lead turn and should only be done if you can definitely out perform the defender or if you are positive the bandit has not detected you. If the opponent continues on his present course, the attacker will roll out with decreased angle-off, but will still have a small aspect angle problem (Figure 4.21). This lead turn may be easily countered by pulling away from the direction the attacker is turning and continuing to build angle-off (Figure 4.22). If the attacker initiates the turn well outside the defender's turning circle, the defender can slow his forward vector (throttle, speed brakes, out-of-plane) and allow the attacker to fly in front of the former defender's 3/9 line (Figure 4.23).



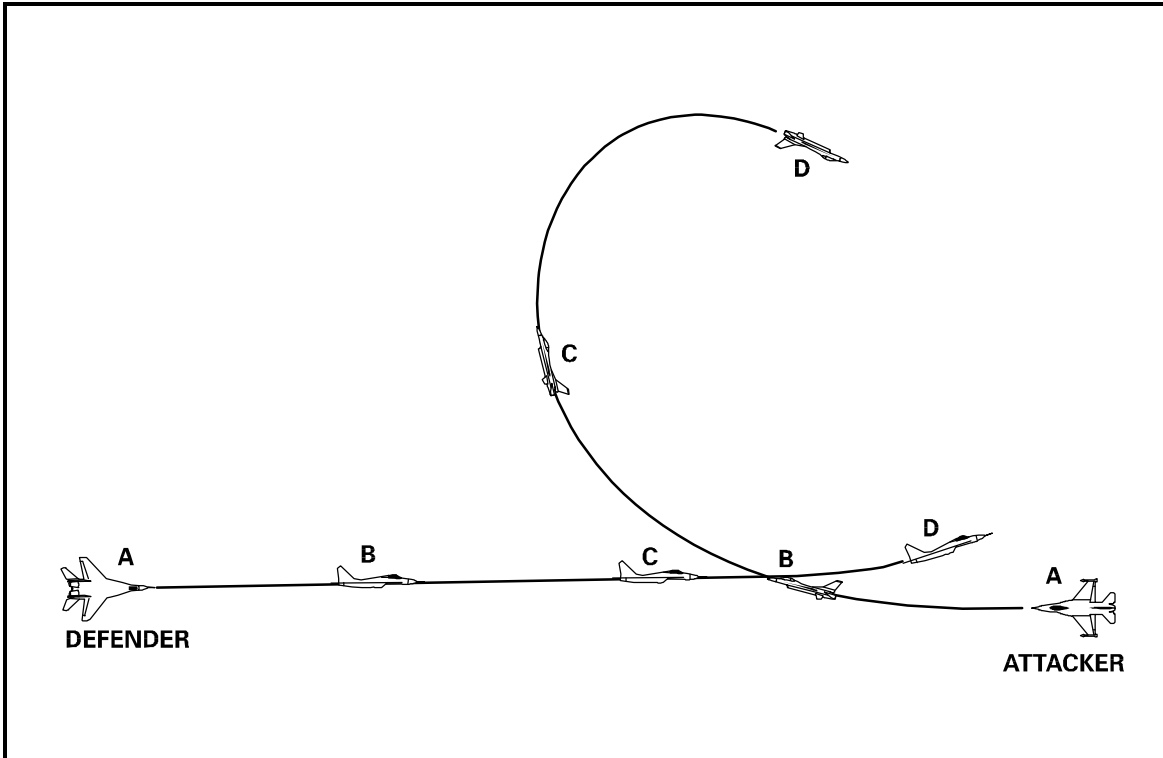


Figure 4.21 Lead Turn Without Turning Room

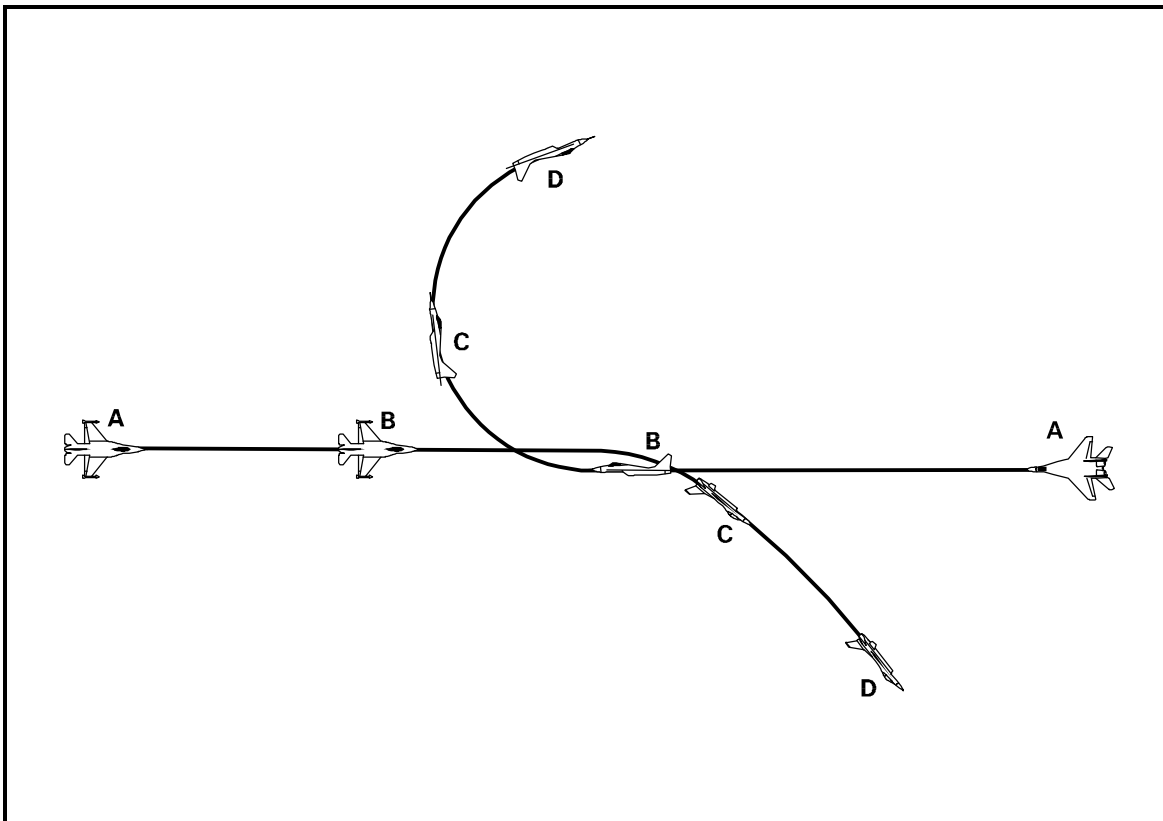
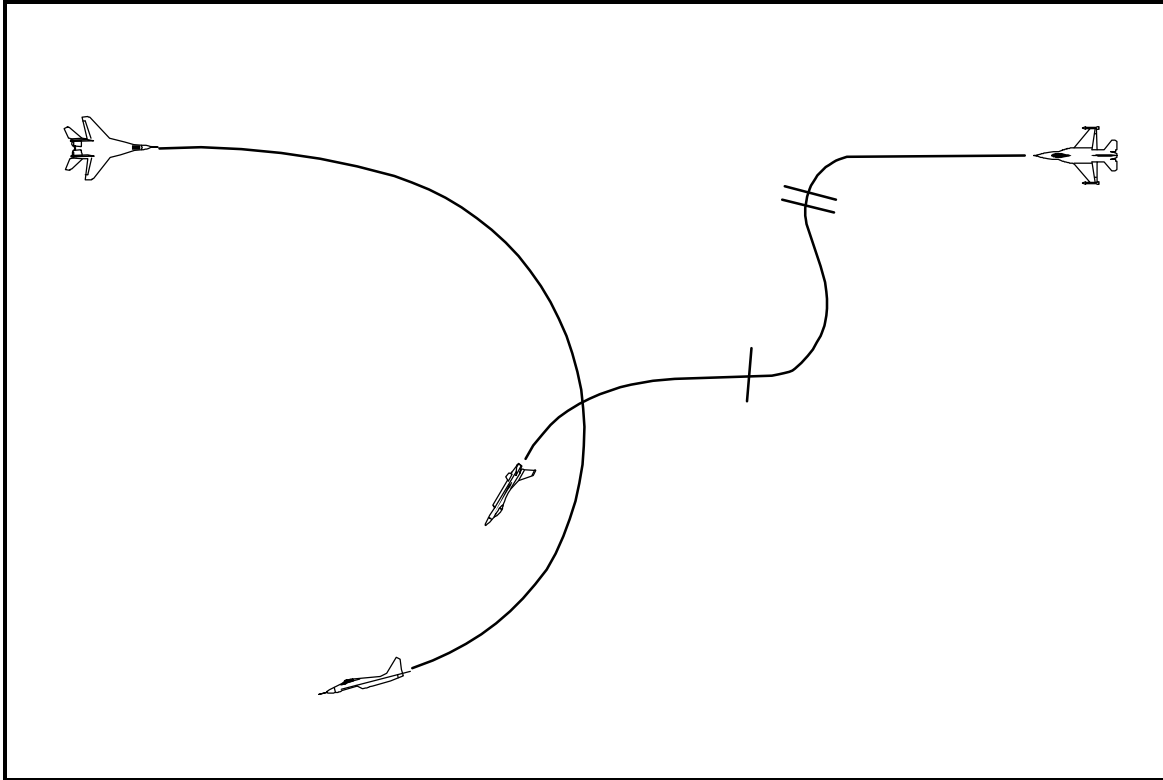


Figure 4.22 Turning Away to Defeat Lead Turn



**Figure 4.23 Use of Vertical to Defeat Lead Turn**

Lead turns can be accomplished in any plane. Assuming airspeed is in the "corner plateau" region, lead turns going down will require slightly less offset than lead turns going up.

A lead turn down or a split-S is useful because it preserves airspeed. This is especially important if the adversary has a predictable flight path due to a low energy state. The adversary must try to deny the lead turn with a turn degraded by the effects of gravity. If the attacker achieves offset above his adversary, but is hesitant to commit to a nose-low slice, he may lead turn in the horizontal. This is done by pulling to a lead point in a plane above the bandit's flight path. Although not as efficient (there is still an aspect problem to be solved) as a turn done in a plane with the bandit, it preserves nose position (the vertical HCA between the attacker and defender) and prevents a vertical overshoot should the bandit counter the lead turn by pulling up and into the attacker.

A lead turn up is effective because it allows visual contact with the defender while possibly placing the attacker in the defender's blind zone. A lead turn coming from low to high takes great advantage of radial G during the terminal portion of the turn (when the attacker's lift vector is below the horizon). The lead turn in the vertical should be avoided if over the top airspeed is not achieved (minimum of 250 KCAS level) or a significant energy advantage does not already exist (ascending aircraft does not have vertical maneuvering potential). Lateral offset should be achieved as necessary to maintain a tally during the maneuver.

#### 4.6.6.1. No-Respect Lead Turn (Lead Turn Without Turning Room)

A no-respect lead turn can be accomplished against a bandit that does not see the fighter or a turn deficient bandit (Figure 4.21). If the bandit does not see the fighter, the end result is an unobserved conversion turn. A turn deficient bandit has either a very large turn radius and/or a very slow turn rate generally because of two reasons—either the bandit is extremely fast or extremely slow.

For example a bandit traveling at Mach 1.3 will have a very large turn radius compared to a fighter near corner velocity. The fighter at corner velocity can begin a lead turn well ahead of the bandit's 3-9 line, giving up angles and even going belly up to the bandit. But because of the bandit's high airspeed

and the inability to perhaps bleed it down quickly, he cannot take advantage of the angles the fighter is giving up.

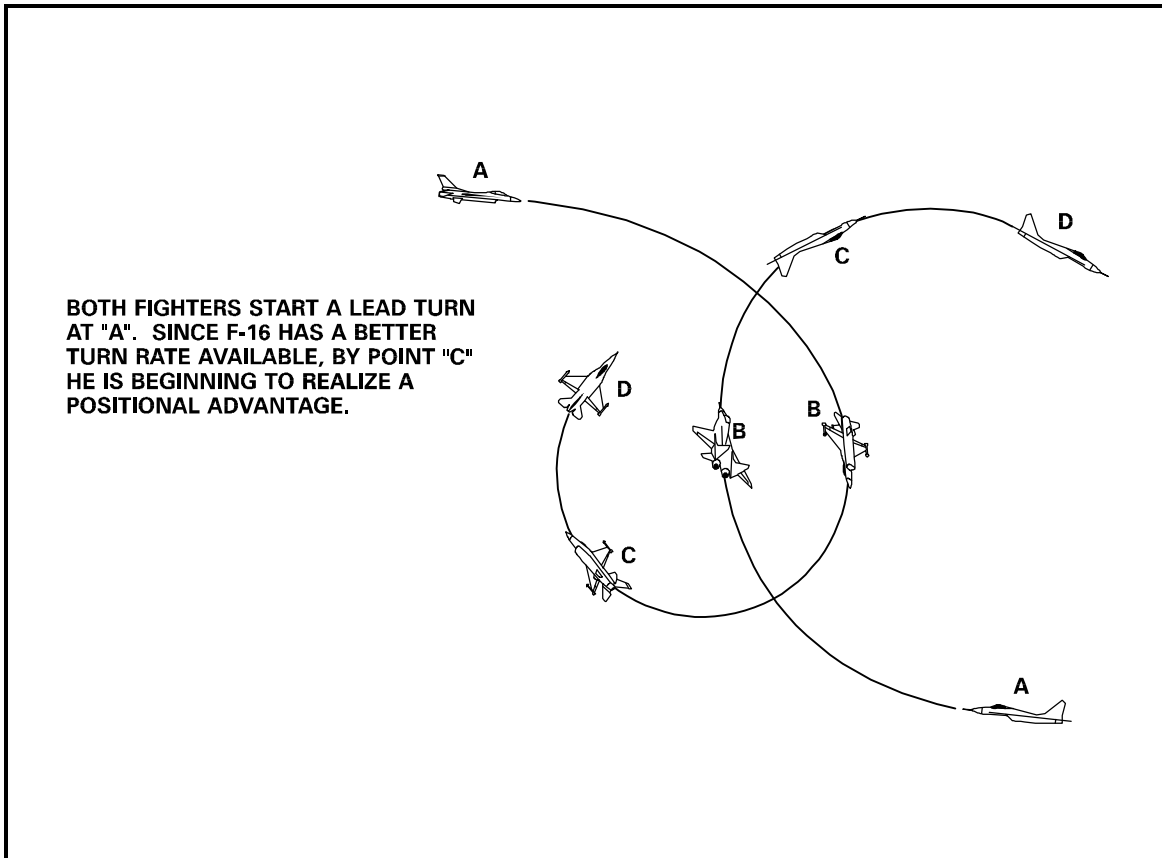
A second example is a very slow bandit coming down from over the top. If a bandit goes vertical and is coming down slow on airspeed, a fighter may lead turn the bandit and even go belly up to the bandit prior to the 3-9 line because the bandit is too slow to bring his aircraft to point at the fighter lead turning in front of him.

The above two examples are extreme cases where a bandit cannot stop a fighter from lead turning in front of him because of an airspeed related performance limit.

#### 4.6.6.2. Counters

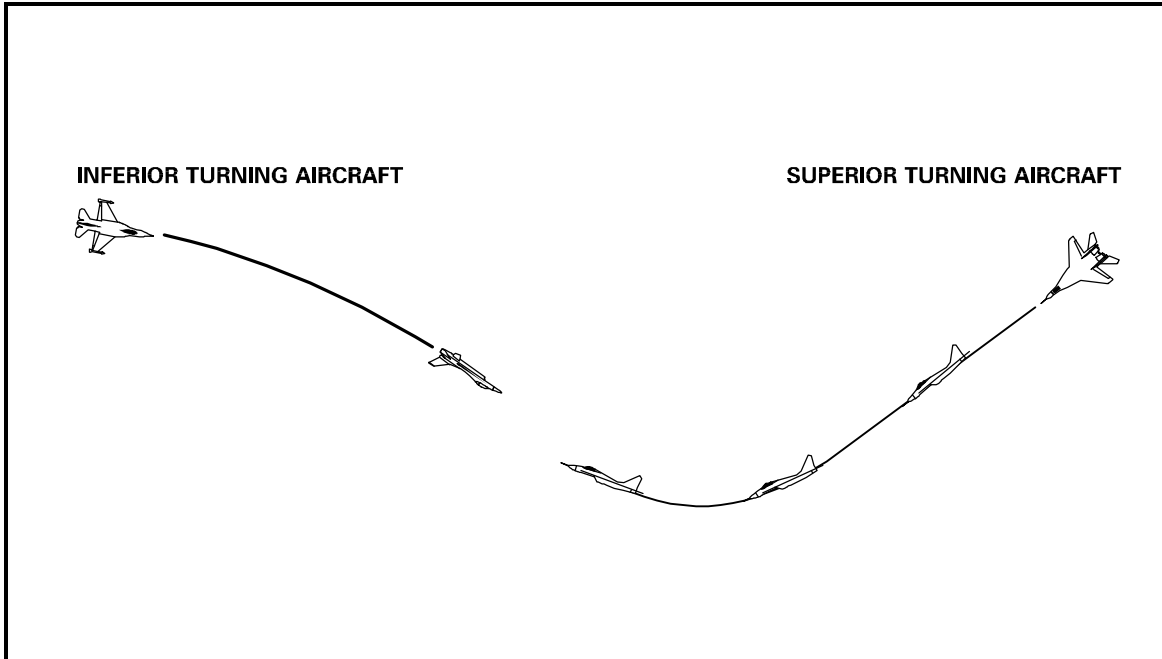
The counter to a lead turn is to remove the offset **prior** to the lead point, i.e., take your share of turning room by beginning your own lead turn.

Against aircraft with inferior turn performance, if the pilot plans and initiates a lead turn at the proper range, he will automatically negate any turn his opponent attempts (Figure 4.24). The opponent with an inferior turn performance will initiate a lead turn sooner than you wish to initiate yours. The inferior turning aircraft will also strive for more lateral offset than you need for your own turn. This can be easily countered by turning to deny his lead turn and initiating your own lead turn at the proper point for your turn capability. This will quickly develop into a lagging contest won by the aircraft generating the best **sustained** turn rate.



**Figure 4.24 Denying Lead Turn Versus Inferior Performer**

Against an aircraft with superior turn performance, or if you have gotten slow and have less turning capability, a defending pilot should fly directly at his opponent, eliminating all offset and denying any chance for a lead turn. It is important that he make the turn to point at his opponent prior to the point where the opponent transitions inside the defender's turn circle. The sooner this is accomplished, the less severe the maneuvering required to deny the lead turn (Figure 4.25).



**Figure 4.25 Denying the Lead Turn Versus Superior Performer**

#### 4.6.7. Energy Versus Position

Energy is the potential to maneuver. However, too much energy can be a dangerous thing. Excessive speed can lead to severely degraded turn performance, minimum time in weapons parameters, and reduced station time. The key to the fighter pilot is the determination of how much energy he needs and how much he is willing to expend for a given positional advantage. BFM allows the achievement of weapons parameters with minimum energy expenditure in as little time as possible. This concept of efficient maneuvering is important because in a tactical situation, it will dictate how much BFM is to be employed in a given engagement. How much predictable time can the F-16 pilot afford on one attack with regard to the entire tactical environment? How much energy or future maneuvering potential can be expended for a given positional advantage? Will that position be sufficient for the kill or will it just prolong the maneuvering, requiring more time and energy? All these questions must be asked and evaluated to determine the trade off for a given situation. Obviously, high energy bleed off for position is justified to achieve firing parameters against a Flogger attacking the home drome, while the same  $P_S$  expenditure may be unwise in an outnumbered sweep vs sweep scenario deep in enemy airspace. Energy and position must continually be balanced by the fighter pilot. BFM is a tool the F-16 pilot uses to achieve this balance—always trading energy for position and using position to employ ordnance, remaining cognizant of his own need for survival.

#### 4.7. Offensive BFM

The primary consideration in offensive BFM is to kill the bandit by arriving in lethal weapons parameters as soon as possible and take the shot. Understanding the concept of turn circles is mandatory to assessing which BFM discussed in this chapter will work in which instances. It should be remembered that BFM is not a fixed set of maneuvers, but rather, combinations of rolls, turns, and accelerations that have been optimized for certain situations and named for the sake of discussion. Since the end goal of any offensive engagement is to kill the bandit, BFM is designed precisely to do just that with minimum time and energy expended.

##### 4.7.1. Objectives of Offensive BFM

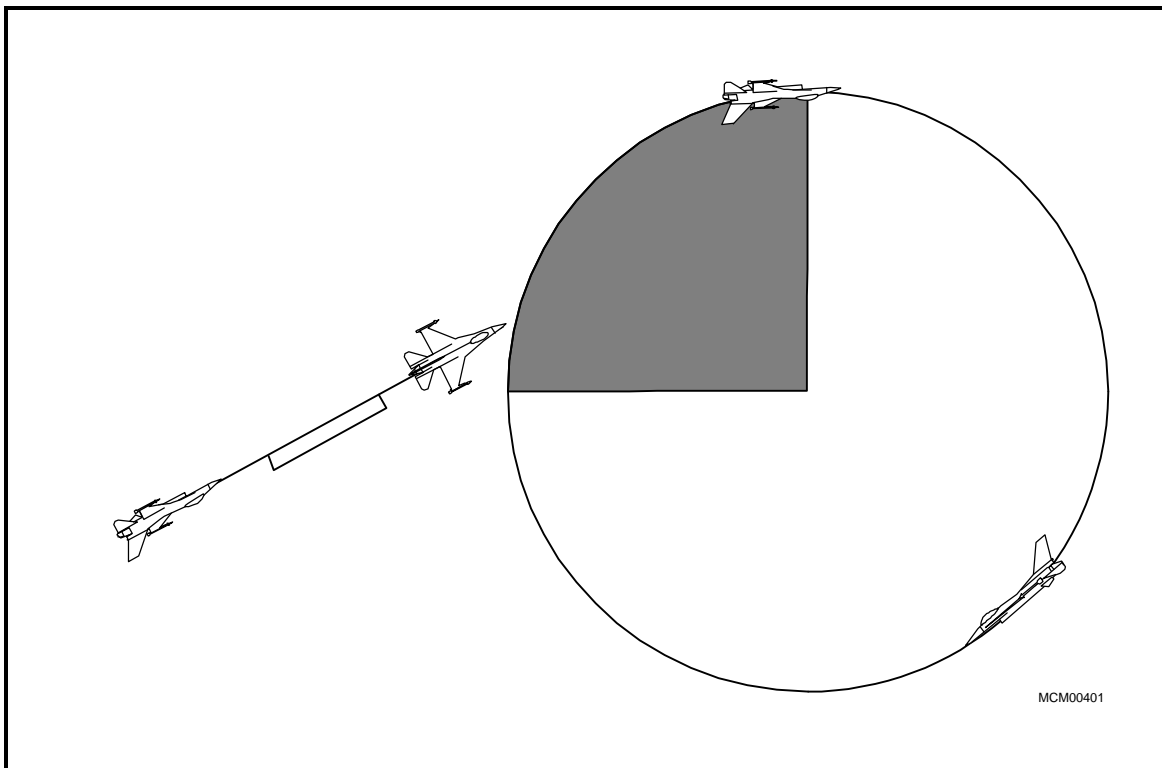
The first and primary goal of offensive BFM is to kill. In order to kill, the fighter pilot must recognize weapons parameters and employ ordnance once in those parameters. If he cannot shoot, he must reposition until he can employ ordnance.

- Gain and maintain sufficient energy to have future maneuvering potential against the adversary.
- Maintain nose/tail separation against the adversary. Offensive maneuvers will position the pilot behind the bandit with sufficient energy to enable him to stay there.
- Allow the pilot to drive into a position from which ordnance may be employed against the adversary.

#### 4.7.2. Outside the Turn Circle

Several things happen quickly/simultaneously (Figure 4.26):

- If able, point at the bandit and fire an AIM-9.
- Select AB.
- Point to where you want to enter the bandit's turn circle. Do not pure pursuit the bandit during missile time-of-flight.
- Assess the bandit's turn.



**Figure 4.26 Outside the Turn Circle**

##### 4.7.2.1. TC Entry Cues

This is one of the most important aspect of flying BFM. You must recognize when you are in the bandit's TC, and what to do once you're there if you ever hope to arrive at an end game kill. Your primary reference should be the LOS across the horizon. If you never changed your initial aim point (assuming it was a good one) then LOS across the canopy works also. But that's not what you should look for because you control that somewhat by where you point and how hard you pull, so look at the horizon. Back to LOS rate. Initially you will see the bandit move very little across the horizon but he will be rotating in space. As you approach his TC, his aspect will begin to stabilize (rotation stops) and his movement across the horizon will pick up. You have entered his TC! The Bandit will probably slide out of the HUD FOV prior to your entering the TC, but it will happen at a low LOS. For the typical set-up this will occur about 10:00 or 2:00, (sounds like 40°- 50° on the locator line) but will vary depending on how hot your entry is. Range is dependent primarily on how hard the bandit breaks and a little on aspect, but 5000' - 6000' is

again typical for what we do, (normally about 6 seconds from "fights-on" with the bandit normally through 120° of turn with aspect about 70.).

Another technique for determining your position relative to the bandit's TC is to evaluate the bandit's present rate of turn. If this turn will bring you forward of the bandit's 3/9 line, then you are outside the bandit's TC. You are inside the bandit's TC when you determine that his rate of turn will not bring you forward of his 3/9 line.

Use the afterburner to gain airspeed. Because you're outside the bandit's TC, the time it takes for you to get there is dead time. Every second the bandit generates 15-20° more angles you'll need to solve and you can't solve any angles until you get to his TC. Therefore you'll want to get there as quick as possible. However, once there you'll need to slow back down by getting out of A/B and/or use of S/B. A good trade off is about 500 knots at the TC entry. Faster and your radius is too large and rate drops off, slower and you'll quickly have to ease off the "G" to sustain corner. Power modulation in the Viper, especially against a thrust deficient bandit is all important, i.e. two-handed turns are a requirement.

#### 4.7.2.2. Point at the Bandit

The TC entry point is a window from where he started (actually just inside) to just short of the center of his TC. Anywhere within this window is the correct solution, however, exactly where will determine the amount of vertical needed to solve the problem. The hotter the entry (i.e. the closer to the center of the TC) the more vertical required. This assumes you are fighting a bandit similar in capability to you. A good rule of thumb is to enter about 2/3 of the way out from the center. Assuming a standard set-up, at the "fights on/Fox II" you need only to roll out and point to where the bandit was (or at the first flare) to hit this entry point. This is the conservative approach, but will enable you to see the TC entry more clearly. How about vertical? This is a wonderful concept, but too low and the bandit can keep his energy up by keeping lift vector on, too high and you delay getting to the TC. Again look for a window, within about 500' high or low is reasonable. If you go low, the bandit can create max angles with lift vector on as well as maintain energy by having his lift vector below the horizon. A level (or even a slight climb) will force the bandit to make a decision. If he keeps lift vector on he bleeds energy, if he keeps lift vector slightly below the horizon he builds you some vertical turning room. The point here is two fold; have a game plan, but realize the bandit may not be cooperative. Constant assessment of what the bandit is doing, and being able to adjust is a must.

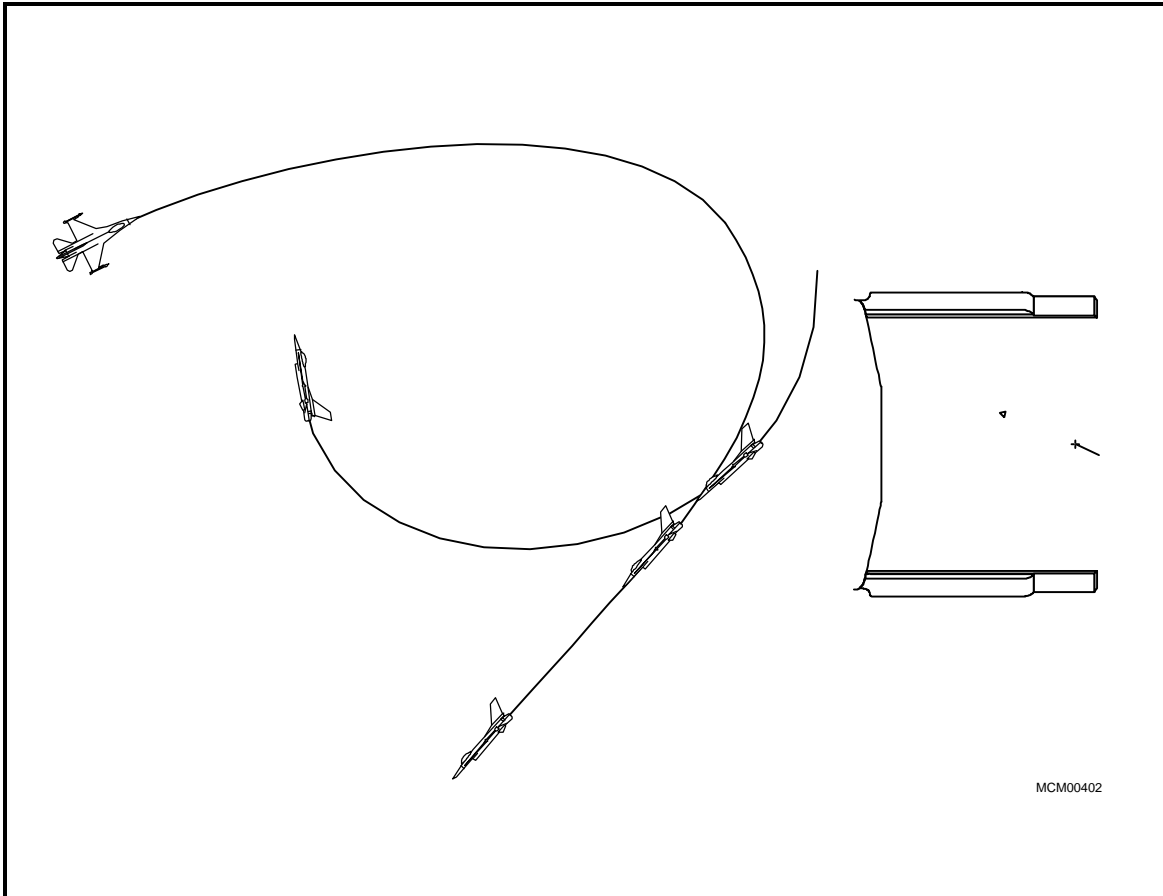
#### 4.7.2.3. Assess the Bandit

Look through the bandit at the horizon beyond. This gives you the best cues to determine the size of the bandit's TC, (and therefore the center of it), the amount of altitude delta you have (space between horizon and bandit is vertical turning room), and most importantly, it will be the best cue for TC entry time.

#### 4.7.2.4. Knowing When to Start Your Turn

You've arrived at his TC (Figure 4.27) but now you need to solve the other problems that have been created, such as angles and range; realize that the bandit will not be in your HUD at this point. Reference the previous discussion on airspeed at TC entry and power modulation. If you see greater than 500 (not likely with a PW motor) pull power to min AB, or fan the boards, you will slow down during your initial turn. Less than 500, leave power set in full AB. As the bandit's airspeed decreases, so does his TC size. When you enter his TC your turn circle will be a bit larger than his initially. Your initial move should be to make a loaded roll to set your lift vector on or slightly above the bandit, and pull. This is initially a limiter pull while you assess range and closure.

During the maneuver, you need to assess what the bandit is doing, along with your range, closure, and heading crossing angle (HCA). This initial turn will take you through about 120° of turn. It is critical to keep your nose in check with the horizon as well as the bandit, + 15°. (Slightly more may be required if you chose to make your entry hotter due to higher aspect angles) Done correctly your flight path will take you slightly outside his, and you will always be looking at the top of his aircraft. What you do from here depends on what type of defense the bandit is doing. For this discussion two will be addressed: check and extend & continuous turn.



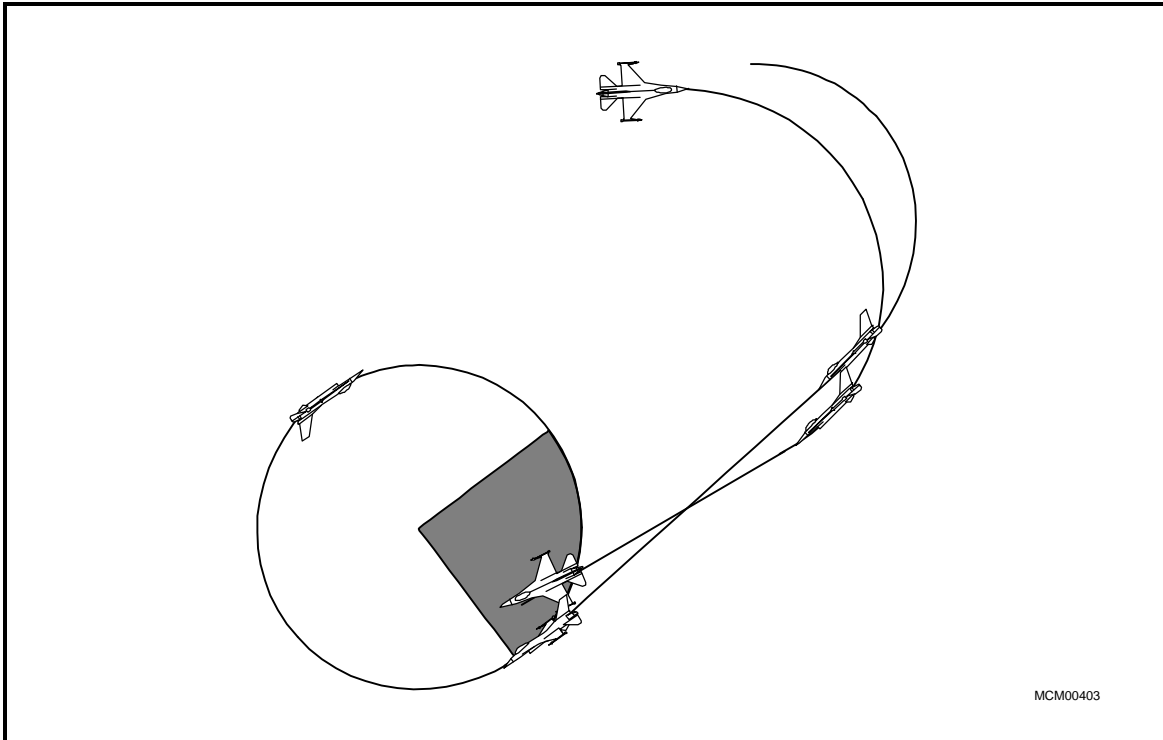
**Figure 4.27 Turn Circle Entry**

#### 4.7.3. Follow-On BFM

##### 4.7.3.1. Check & Extend

There are a number of different cues the bandit is doing this (Figure 4.28). Probably the first is the ability to pull the bandit to your nose with relative ease. Next is a rapid change in aspect. During your initial turn you were continually looking at the top of his aircraft. As the bandit extends, the burner can become the focus of your attention. Another cue is LOS. When you entered his TC you saw rapid LOS across the horizon. As the bandit extends his LOS across the horizon stops. The last cue is range. During your initial you closed rapidly, but the extension will again increase range. When you see this the bandit is trying to get something you are trying to deny, energy and range. Your reaction should be to stay on the limiter and point at him as quickly as possible to threaten him. This should bring him back into a turn, if not shoot him with a missile. the bandit's extension has opened up the range enough to place you outside his turn circle, so think about getting there again. Your move should be another TC entry the same as before, but it will be quicker, and both the bandit's energy and your energy are diminished. Resist the urge to point directly at him. This typically happens with new BFMers, and though it can be a quick kill option, it's best left to be learned as experience increases.

Your goal is to get to a position of control (the control zone, his elbow, etc.) and beat him down on energy until you decide to prosecute. Typically you will arrive there after 2 or 3 extensions by the bandit, provided you didn't let him extend too long each time. Transitioning to the eventual kill with the gun will be discussed later. Take your time, be patient, and the kill will happen quicker in the endgame.



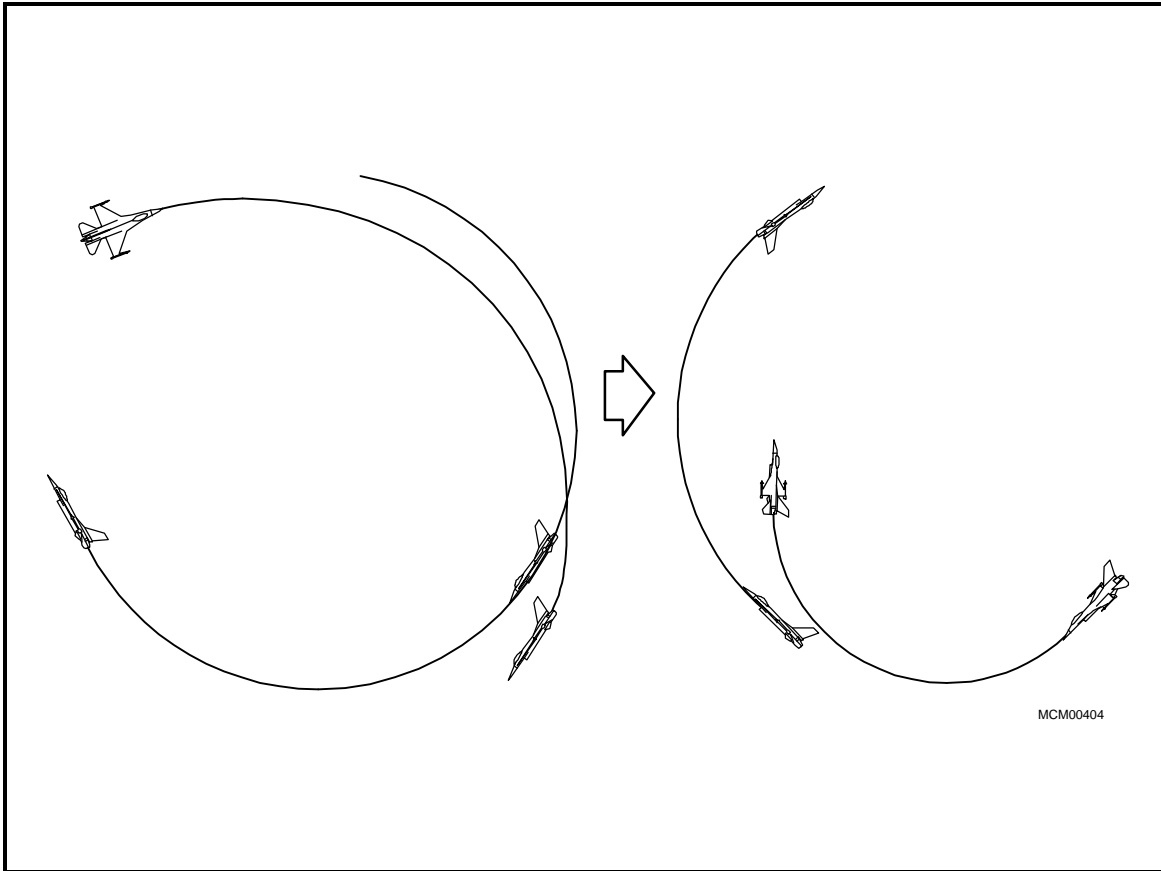
**Figure 4.28 Check and Extend**

#### 4.7.3.2. Continuous Turn

The cues you have that this (Figure 4.29) is the bandit's game plan are opposite of the check & extend. You may be able to pull him to your nose, but it will unnecessarily deplete energy require all you've got and is not the appropriate move. Your first cue should be the continuous LOS across the horizon. Also, you'll continue to see the top of his aircraft. Finally, the range between you and the bandit does not open up by virtue of the bandit's maneuvers. Depending on how well he flies this defense will determine how fast you beat him down on energy and kill him. He is presenting angle problems, and trying to force an error out of you (most notably bleed down your energy). Your BFM should not let this happen. You will need to threaten him to get him to bleed energy, but if you try to make it happen in one fell swoop you'll lose. When you detect this is his game plan, ease off of the turn to preserve range, position and energy. This will solve your angular problem by itself.

As a target, try to close no closer than about 3000' initially and maintain about 350 kts (300 as an absolute min). The 3000' is an approximation of his turn radius. As long as you are outside this, and you make a slight flight path overshoot (which will happen), he can't do anything about it. This also happens to be an approximation of your turn radius, and you will need turning room to threaten/prosecute. Preservation of range is critical here and the greater your HCA the more you'll need. As long as your HCA is within about 30° as you slide outside of his flight path this range is sufficient. If the HCA is greater than that you'll need more range, so shoot for about 4000' - 5000'. Maintaining 350 KTS will optimize your turn radius and your turn rate. The closer your nose is to the bandit the more threatened the bandit will feel, and force him to turn harder and deplete energy. Using a series of small high and low yo-yo's will eventually bring your nose into lead thus forcing the bandit to do something. Do not get your nose too low, you'll be fighting God's G and the bandit, and you'll lose. Along with the yo-yo's, your turn circles will be slightly offset, so even if the bandit has equal energy initially, your nose will arrive in lead. Be patient!! Don't let your energy deplete until you are sure his is gone and you are ready to kill. Cross check your range and closure at the initial turn to avoid setting yourself up to pass too close to the bandit with HCA out of control ( i.e. setting up a reversal opportunity for the bandit).





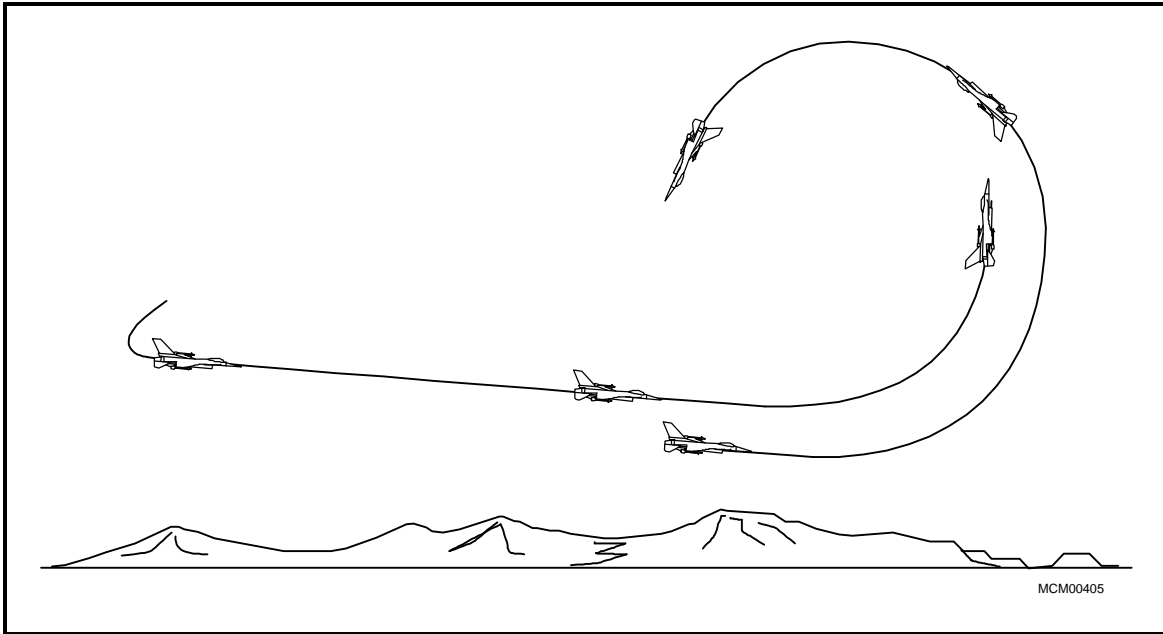
**Figure 4.29 Continuous Turn**

Common Errors:

- No AB: delays entry, overall energy is lower.
- Too hot of a TC entry: set up a reversal opportunity, best case delay the kill unnecessarily.
- Late TC recognition: flying out the back, letting the bandit get a good extension.
- Pulls too hard: range/closer problem, depletion of your energy.
- HUD BFM: develops closure problems quickly, sets up an overshoot.
- Being greedy: PATIENCE is the key to success.

#### 4.7.4. Vertical Considerations

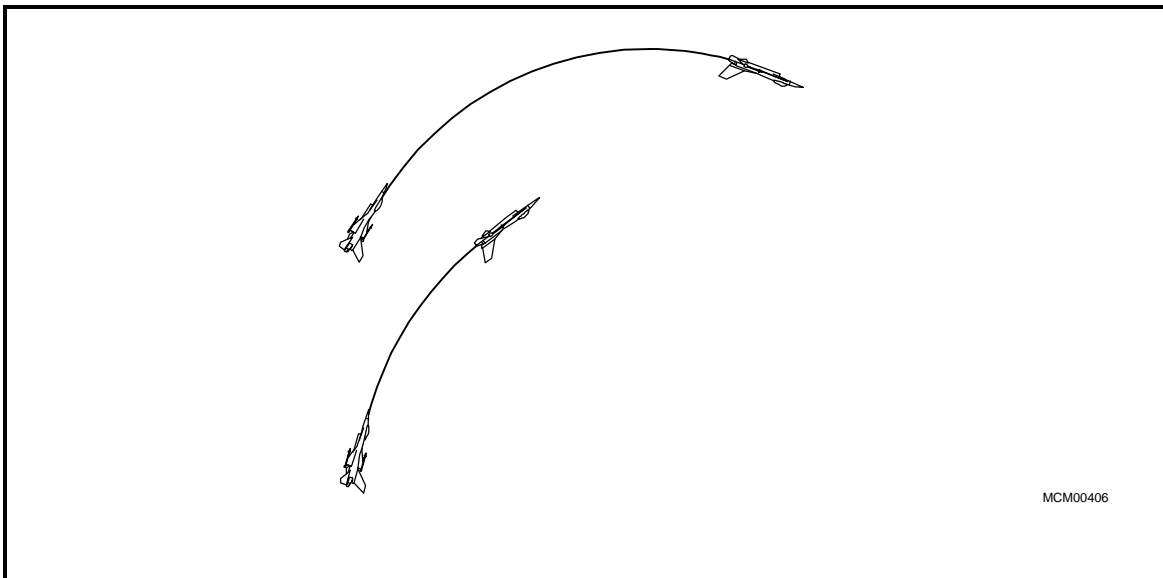
The concepts for a vertical fight (Figure 4.30) are similar to other BFM skills. Look for TC cues, cross check over the top airspeed, and prosecute the attack. When you follow the bandit up, it's not a limiter pull into the vertical. Perform a loop (like back in TR), except at the top you can pull harder to threaten the bandit. If your airspeed is significantly greater than his, you may be able to use that to prosecute across the top, but you may not have a free overshoot. Keys here are: cross check closure, and ensure his nose is committed down before you go for the kill. The biggest error made happens at the onset. If the bandit goes up and you immediately follow. Essentially you're cutting across the center of his TC, and creating problems talked about earlier. Remember to point to where he was and make a good TC entry.



**Figure 4.30 Vertical Fight Entry**

#### 4.7.5. Closing for Guns

This section applies not only to perch sets, but also when you transition from the long range offensive sets and decide it's time to give the bandit a shower of 20mm (Figure 4.31) from the control position. If the bandit has 300 kts, he can generate tremendous problems and you probably won't maintain the control position. Normally don't try to gun him until he is 250 or less (there are a number of ways to tell his airspeed: closure combined with aspect, and looking in the MFD). There are two options you have as the attacker at the "fight's on". The first is pull lead and gun him now, The second is to bid to lag and beat his energy down.

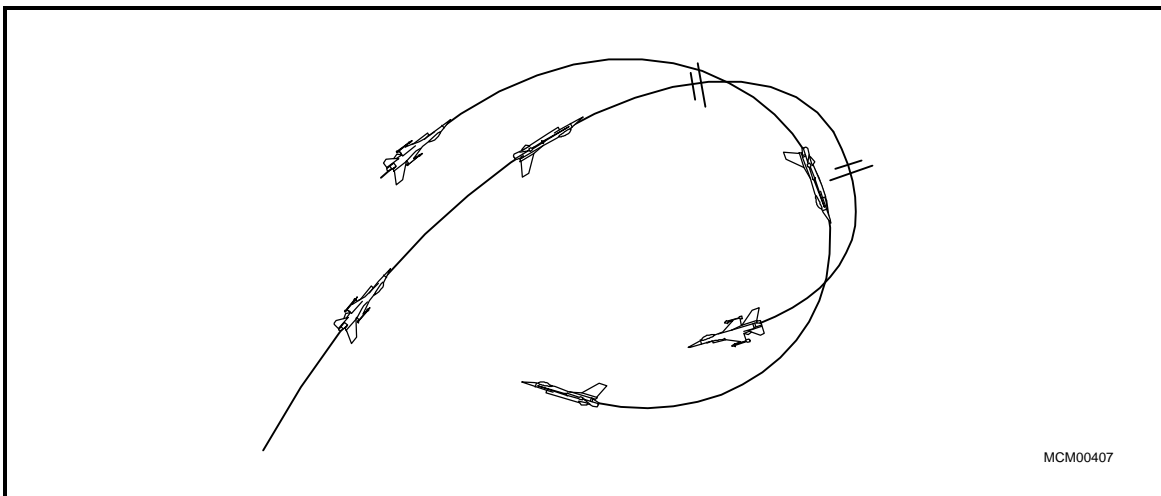


**Figure 4.31 Closing for Guns**

If you elect to pull lead and gun him from the start, prepare for the possible outcomes. If he's a duck and simply puts lift vector on and pulls, he dies, fight's over in 3 seconds provided your pipper control is on the mark. If not, or he jinks, you now have a closure problem and angle problem which you may not

be able to solve very quickly especially if you continue to press the attack and follow his jink. The way to keep out of trouble here is to pull lead, if he even hints at a jink it's time to reposition while your still outside 2500'. If you decide to shoot, do so with a lethal burst, then reposition immediately. If the shot is good, call him dead. If it's not, you're already solving the closure problem before it gets out of control.

The other option is to make a bid to lag (Figure 4.32) to beat the bandit's energy down before you gun him. This option is highly recommended for the less experienced, and should be your primary game plan until your proficiency increases. The bid to lag can be accomplished in a variety of ways. The simplest is to ease off of your turn to float back to the bandit's elbow. This will keep energy up so you can pull your nose to lead at your discretion. Power can stay in mil. It also keeps your nose in a threatening position to the bandit and prevents him from selecting AB (If he does shoot him with the missile). You may also elect to reposition using a slight out of plane maneuver, This is acceptable and does kill closure rapidly, but may also send a non-threatening message to the bandit by going out of plane while his energy is still up. Executed correctly this technique is fine, but make it quick, small, and crisp. Remember this is two handed BFM, AB may be required but not usually on the first move.



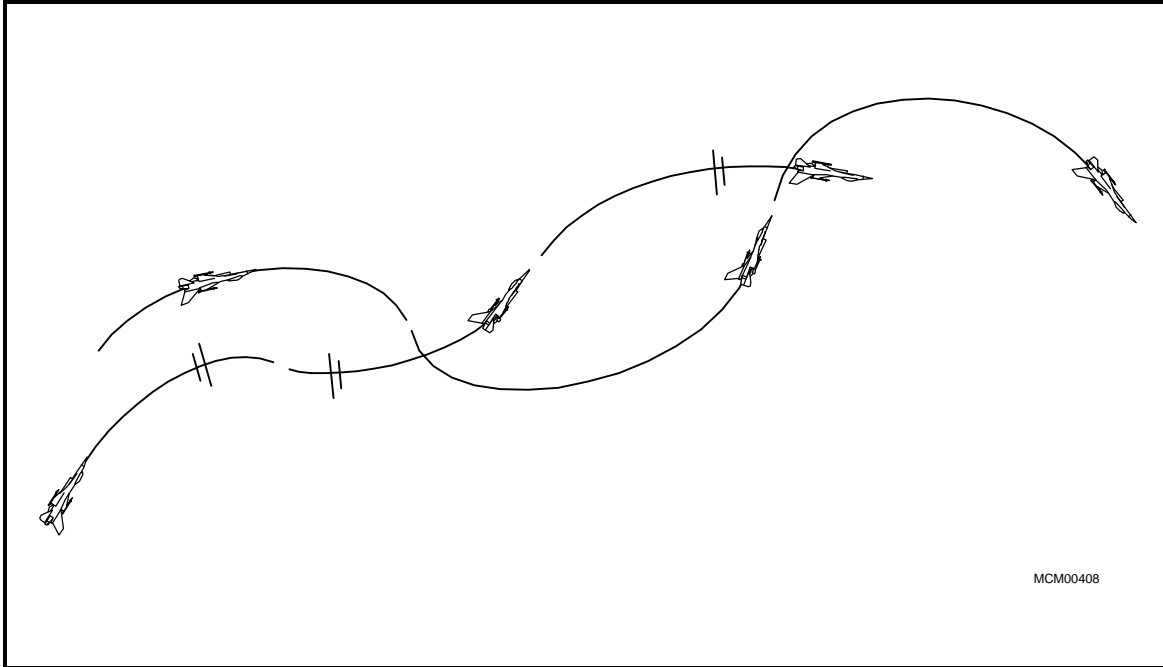
**Figure 4.32 Bid to Lag**

The bandit has a couple of options to try and force an error. If he continues his turn, think offset turn circles, and small yo-yo's. He's on the down side of the Ps curves, so you're controlling the fight from the start. One of mistake is to bleed your energy before him. Ride the smoke trail, and monitor his airspeed. When he's down to about 200 kts you own him. Avoid being low and not in lead, you'll scrape off on the floor first. As long as you're slightly high, the bandit will have to flatten his turn to avoid the floor. When he does you can trade your altitude for turn rate and gun him.

If the bandit reverses (Figure 4.33) in a nose counter or roll underneath, he's trying to cause several problems. First is to get your nose out of sync with his, and make you fly a shorter string causing a closure problem. You can control this with an appropriate reposition to his six. Idle / speedbrakes may also help. Either a yo-yo type maneuver out of plane or a lag roll will work, but be extremely careful not to bury your nose or it may stagnate the fight. The idea is to stop your forward movement to preserve range. If you keep a constant cross check of range and closure, and solve it early, you'll stay behind him all day. If you delay, you're sure to find yourself in a stack or defensive. As a rule of thumb at 2000' if you see 100 knots of closure, reposition, At 1500' if you see 50 knots, reposition. This is two handed BFM, using small crisp maneuvers. When in doubt, reposition! It can't hurt, and you'll preserve your offensive position.

Common Errors:

- Poor Vc control; leads to overshoots, reversals, or stacks.
- Exaggerated repositions; allows the bandit extension and turning opportunities.
- Poor pipper control; don't waste your bullets.



**Figure 4.33 Bandit Reversals**

#### 4.7.6. Slow Speed Fighting

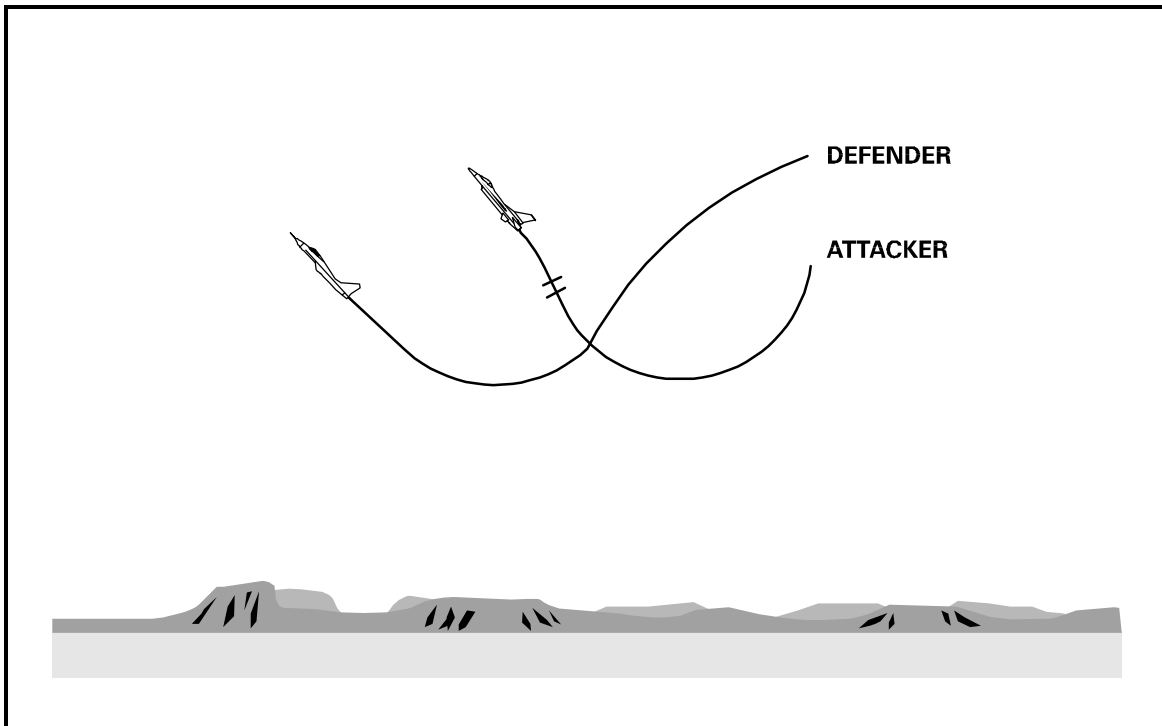
If late recognition of undesired closure/range occurs, the bandit may reverse and force a slow speed fight. There are three common types of slow speed fights: flat scissors, rolling scissors, and high/low stack.

##### 4.7.6.1. Flat Scissors

A flat scissors is the result of an in-plane overshoot. Given an energy advantage, exclusive use of the vertical may exist. If so, reposition high and loop the bandit. Be patient and drive to his six o'clock position prior to committing the nose back down. Without exclusive use of the vertical, a determination must be made in relation to the bandit's turn circle. At slow speed, turn circles may be very small (1200' radius or so). If outside his turn circle, pull with lift vector on and attempt a snap shot. If the snap shot is denied/defeated, attempt a lead turn to gain 3/9 line advantage. If the lead turn is denied or the scissors starts from inside the bandit's turn circle, forward velocity relative to him must be stopped to gain 3/9 line advantage. To do so, align fuselages and set the wings relative to the horizon to stop forward motion. Power/drag can be used to slow forward velocity followed by max AB to maintain pitch attitude. When the bandit begins to move forward on the canopy, pull to his six o'clock to establish a 3/9 line advantage. If both of you are pulling for a high six o'clock position and neither establishes a 3/9 line advantage, a rolling scissors will result.

##### 4.7.6.2. Rolling Scissors

In a rolling scissors, the pilot that can point, intimidate, and cause the other pilot to stop pulling should have the advantage. If unable to point and intimidate, then stop the rolling when the nose is above the horizon and the bandit's nose is below the horizon. By rolling out with the nose above the horizon, forward velocity is slowed. Because the bandit's nose is below the horizon, he should have a greater forward velocity. This should result in a 3/9 line advantage for you (Figure 4.34). If a rolling scissors continues, then both aircraft's airspeed will decrease so that the scissors transitions to a vertical rolling scissors. In a vertical rolling scissors, the opportunity to stop the nose above the horizon may not occur. Therefore, attempt to pirouette in the vertical and point to intimidate the bandit. A vertical rolling scissors fight will lose altitude rapidly, maintain SA on altitude lost and terrain clearance. When a rolling scissors transitions to a horizontal fight (neither pilot having a 3/9 line advantage), the fight may result in a high/low stack.



**Figure 4.34 Forcing the Bandit Forward**

#### 4.7.6.3. High/Low Stack

A high/low stack can result from an overshoot in the vertical or stopping a rolling scissors. If the high man, use power to gain turning room above the bandit. Keep sight by weaving slightly during the climb. Be sure to keep the nose above the horizon to prevent an increase in forward velocity. Attempt to get his nose out of synchronization (sync) to gain lateral as well as vertical turning room. At approximately 3000' of turning room (adversary outside the turn circle), maneuver to gain 3/9 line advantage. While the high man has a slightly higher potential energy, the low man has the advantage of an easy tally. Try to mirror everything the bandit does to force his loss of sight, but not to the point of losing lift. This will deny him lateral and vertical turning room, forcing the bandit to roll to regain sight. If he rolls excessively, his nose will drop increasing his forward velocity. Once the 3/9 line advantage is gained, maneuver to the bandit's six o'clock and attempt a gun shot.

#### 4.8. Defensive BFM

The following discussion of defensive BFM is predicated on an understanding of offensive BFM. In defense, realizing the mistakes of the attacker gives the defender his best chance of role reversal or escape. To recognize the attacker's mistakes the defender must know offensive BFM concepts. The primary objective of defensive BFM is survival. Unfortunately, you are looking over your shoulder, often under high G-load to accomplish this. More than any other situation in flying, defensive BFM is a physical problem. It hurts to pull G's and look over your shoulder. The ramifications of being physically unprepared for the defensive BFM arena should be obvious. In the F-16, it can kill you. Physical conditioning and proper body positioning are a must!

##### 4.8.1. Objectives During Defensive BFM

There is no magic maneuver you can use on defense which will automatically change you to an offensive position against a similar bandit. In order for you to go offensive or separate, he must make a mistake. Therefore, it is essential you maintain a tally so you can take advantage of his mistakes, assuming he makes any. Your maneuvering on defense must be weighed with keeping the tally. If the bandit doesn't make any mistakes, or makes fewer than you, the best you can hope for is to keep him from employing ordnance against you. As the engagement continues, this can become extremely frustrating

and there is a tendency to give up. Your will to live must remain high. As long as the bandit isn't shooting, your defense is working. There are two basic objectives during defensive BFM:

- Survive the bandit's attack. Deny the bandit weapons employment opportunities. Defeat any weapons employed by the bandit.
- Separate or kill the bandit.

There are a few principles that are important if you intend to survive:

- First is the will to live. Whatever it's for it doesn't matter, but the instant you give up you die. Once this attitude has been established the fight may commence.
- A game plan is important, and a couple will be discussed later. However, if the game plan you decide on is not working, do something else.
- Keeping a tally is a must! Do whatever it takes not to lose the bandit once you have him in sight.

BFM is a constant trade-off between energy and position. Only expend enough energy as required and no more. Airspeed is rate, and rate is critical in defeating ordnance and causing angular problems for the bandit. If you give up airspeed and don't get anything for it, you'll die. However if you try to conserve airspeed at the wrong time, you'll offer the bandit a shot opportunity. Don't die with airspeed or altitude below you.

Along the same line is nose position relative to the horizon. Don't get it buried or you become extremely predictable which makes the bandit's job a lot easier.

#### 4.8.2. **Bandit Outside the Turn Circle**

The initial turn is critical, and sets the stage for the rest of the fight. It should be almost reactionary, but watching the bandit throughout is a must. At the "fight's on" call, a break turn needs to be initiated. This means roll to set your lift vector (on the bandit or slightly below the horizon), power in mil, pull smoothly to the limiter, and dispense flares. Lift vector position is very important. Lift vector on the bandit will prevent him from obtaining out of plane turning room. However, if the bandit stays level or climbs slightly, you'll bleed airspeed quicker, and once below corner you'll lose turn rate. Lift vector below the horizon will allow you to sustain a good turn rate longer, creating more angles on the bandit, but it may also give the bandit some vertical turning room high. Either is acceptable, but realize what your gaining/giving up with each, and know how it plays into your game plan. There are a number of ways to visualize your lift vector: the top of the canopy, the vertical stabilizer, or bandit's relative position on the horizon.

This turn must be on the limiter! You must create as many angles as possible before the bandit gets to your turn circle. With this in mind, the need for a proper straining maneuver is paramount. Anticipate the G onset. Also, it is important to blend in the G quickly and smoothly, rather than a snap to 9 G's. A non-limiter turn makes the bandit's job easier.

Flares need to be expended to decoy missiles in flight as well as missiles before they ever come off the rail. You must continue to expend flares as long as the bandit is in a position to shoot a missile. This varies considerably depending on the threat, but for the purpose of this discussion, assume the bandit has an off-boresight capability of 30°.

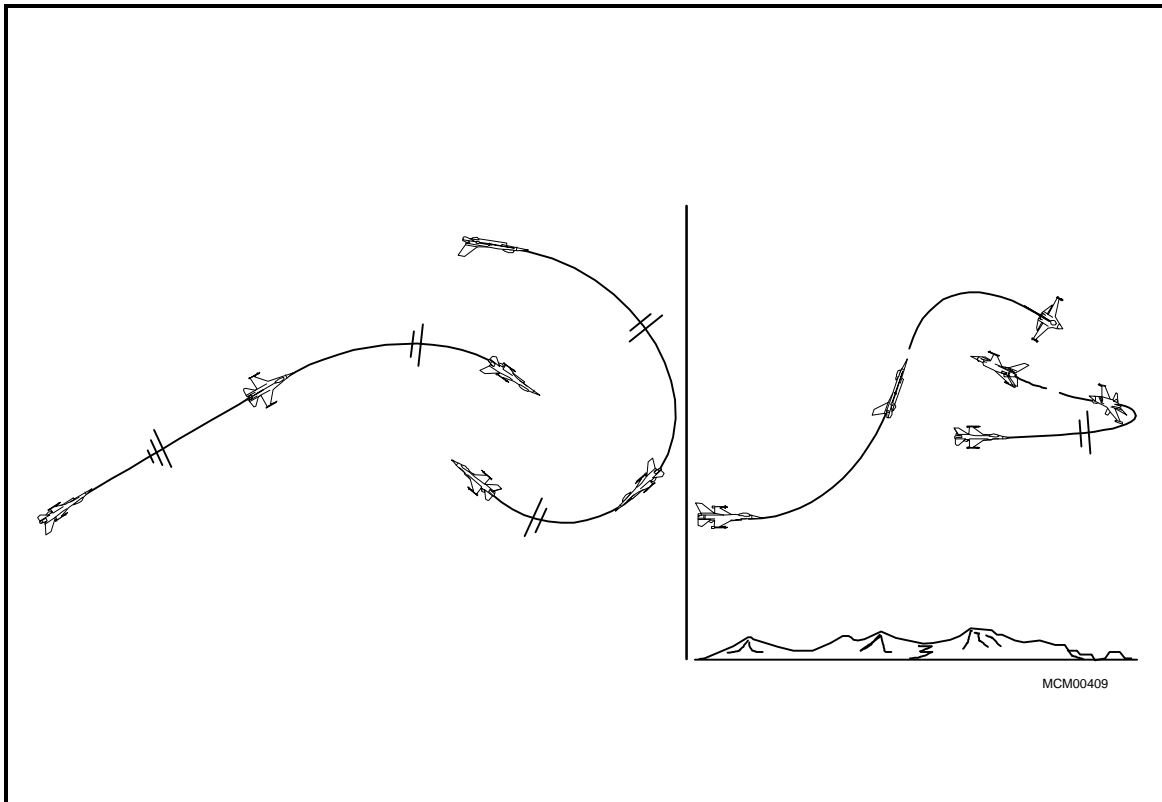
During this break turn, assess what the bandit is doing and determine what your next move will be. What you will see for the first part of this break turn is the bandit tracking forward on your canopy. This is good!!

#### 4.8.3. **Bandit Options**

What the bandit does will depend on his game plan, aircraft capabilities, and pilot abilities. This discussion will be limited to the bandit making some big out of plane maneuver, going to pure/lead pursuit, or making a bid for lag.

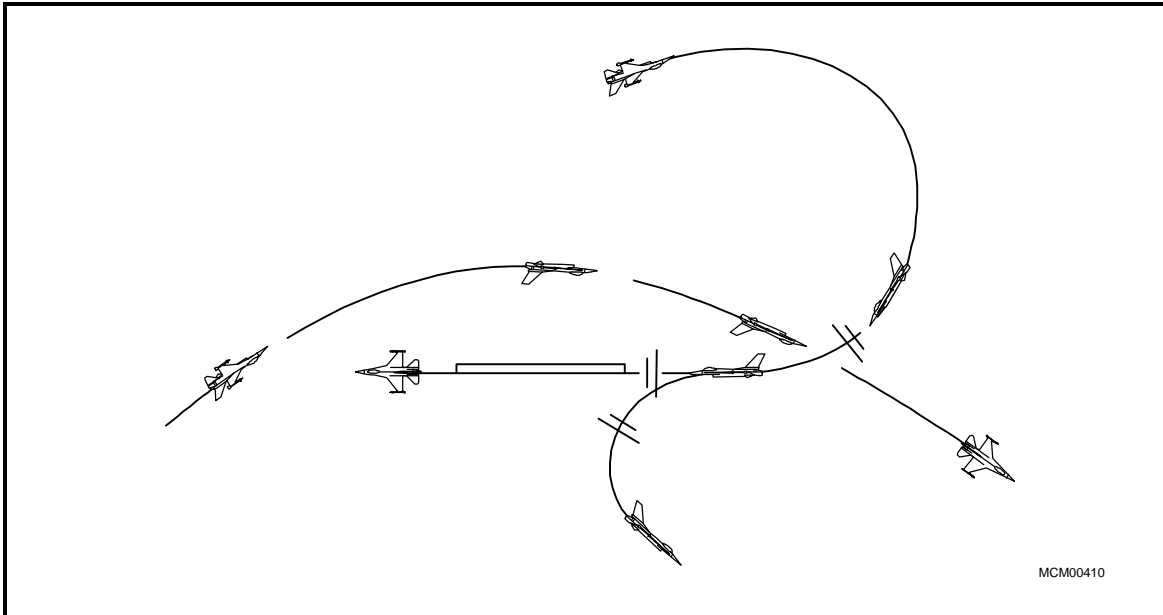
If the bandit elects to make a big move out of plane (Figure 4.35), he is going for turning room and probably doesn't think he has a turn capability equal to yours. Don not allow huge amounts of vertical turning room. The missile threat will go away rather quickly, so your move should be to select full AB, put lift vector on him, and continue the pull on the limiter. Depending on the amount of vertical, he may

not have ever entered your turn circle. In this case you should be able to pull him to the front of your canopy and pass him high aspect. This pass will most likely be low to high for you, and give you an opportunity to reverse on the bandit. Reversals will be discussed later.



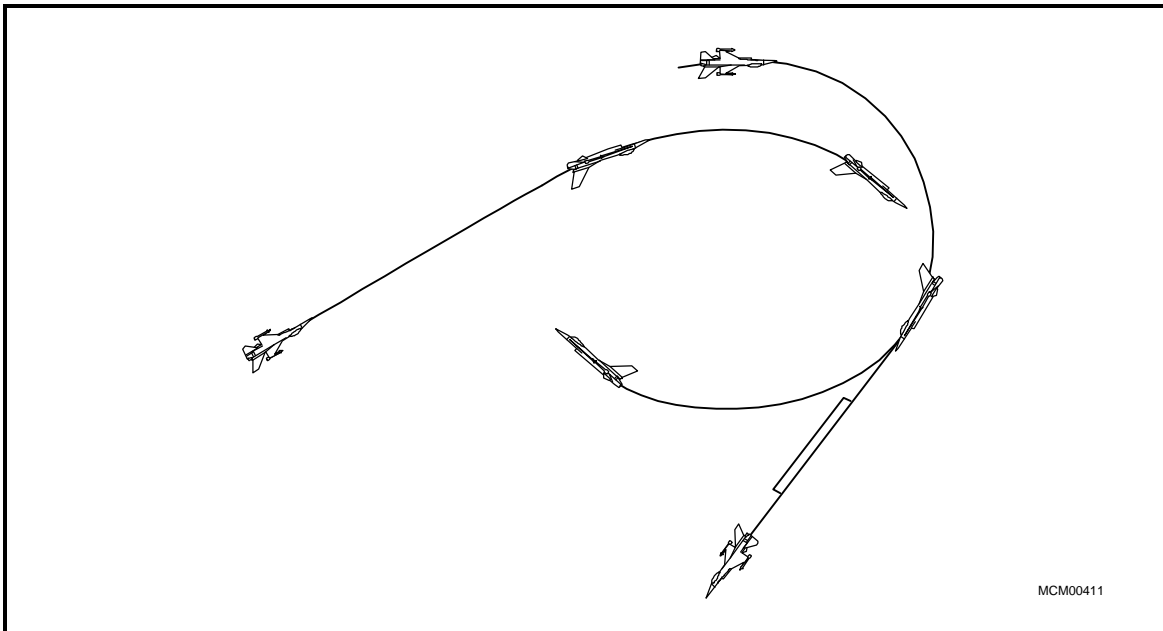
**Figure 4.35 Bandit Maneuvering Out-of-Plane**

If the bandit elects to go pure or pull lead pursuit he may be trying to separate (Figure 4.36), he may not understand the concepts of BFM, or he may just be very aggressive. He is definitely trying to shoot you, be it with a missile or the gun. What you will see is constant forward movement on your canopy by the bandit. Also you will see his nose on or lots of belly and intake. Your actions should be to continue to dispense flares for the missile, and continue to pull on the limiter to generate as many angles as possible. The bandit also could be trying for a high aspect gun shot so be prepared to get out of plane at about 4000'- 5000'. This out of plane maneuver does not need to be excessive, about 15° will suffice. A couple of options are available. For a short period of time there is an overlap between the missile WEZ and the gun WEZ, so you may be defending against both at the same time. Once the missile has been min ranged select AB. Min range for the missile is affected greatly by aspect angle and Vc, and should occur at about 4500'. Watch the bandit!! If he repositions early you will have to revert to your defensive game plan. If the attack is pursued he is either preparing for a separation or setting himself up to give up 3/9. In this case you may elect to separate. Recheck full AB and unload to accelerate as fast as possible. Check to keep the bandit in sight, and continue to assess range and bandit intent. Your other option is to reverse on the bandit.



**Figure 4.36 Separating Bandit**

If the bandit makes an initial bid to lag (Figure 4.37), he probably has the intention of staying in this fight, and knows what he is doing. You will see forward LOS on your canopy initially, then as the bandit enters your turn circle he will stop then move aft. Also you will see the top or side of his aircraft, and his nose off of you. You have two options: either a check and extend defense, or a continuous turn defense.



**Figure 4.37 Bandit Bid to Lag**

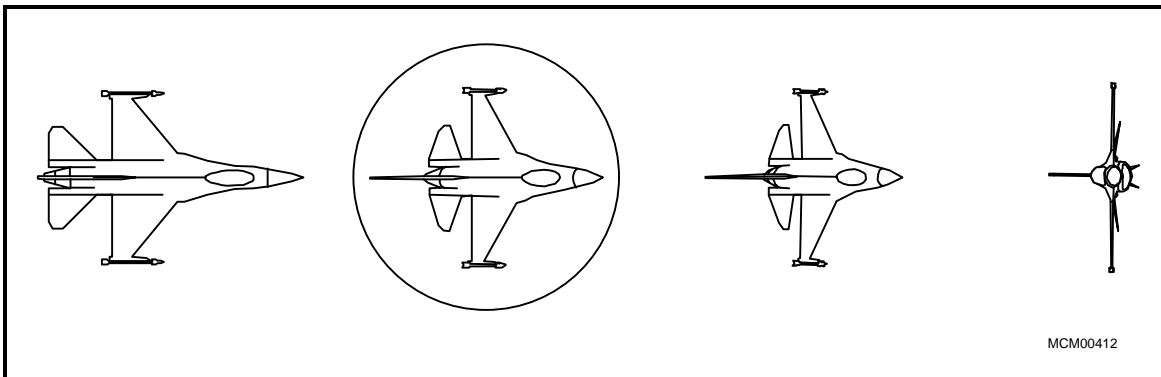
#### 4.8.4. Check and Extend Defense

The concept behind a check and extend defense is to get energy when his nose is off, and try to increase the range between you and the bandit. So whenever you turn it's on the limiter, and when you extend it's with both hands forward. Continue to turn on the limiter until the bandit starts to move aft on your canopy. With the bandit's nose off of you (which may happen before he enters your turn circle) select full AB. Your next action is to unload. You've just been at 9 G's so ensure you unload to less than 1 G



and not to 2-3 G's. Rolling out of the bank as you extend will telegraph your intentions, so stay in the bank. Your nose should be slightly low, but not buried, and most importantly maintain sight of the bandit.

What you are looking for is nose rate and nose position. At first you will see a lot of plan form which will decrease as the bandit tries to pull you to his nose (Figure 4.38). Ideally, you need to start back into your turn before his missiles are a threat. So when you assess that the length of his aircraft is about equal to the width, get back into a limiter turn. Turning now will allow you to start the turn in AB, if you wait a bit longer the turn will be a full fledge break again. When you turn may also be dictated by airspeed. If you are guaranteed to stay and fight, you should start you turn at about 450 kts to optimize turn performance. When you are within 30° of his nose, get back to mil power and expend flares. Now look for the same cues as before as to when you have the opportunity to extend again. Realize that the check and extend defense may allow the offender to salvage a poor TC entry.



**Figure 4.38 Bandit Planform Views**

This process continues until the bandit makes a mistake or you need to transition to a guns defense. The bandit's options are the same as previously discussed, and should be dealt with in the same manner. As this fight progresses, your opportunities to extend, and the length of your extensions will decrease depending on the bandit mistakes.

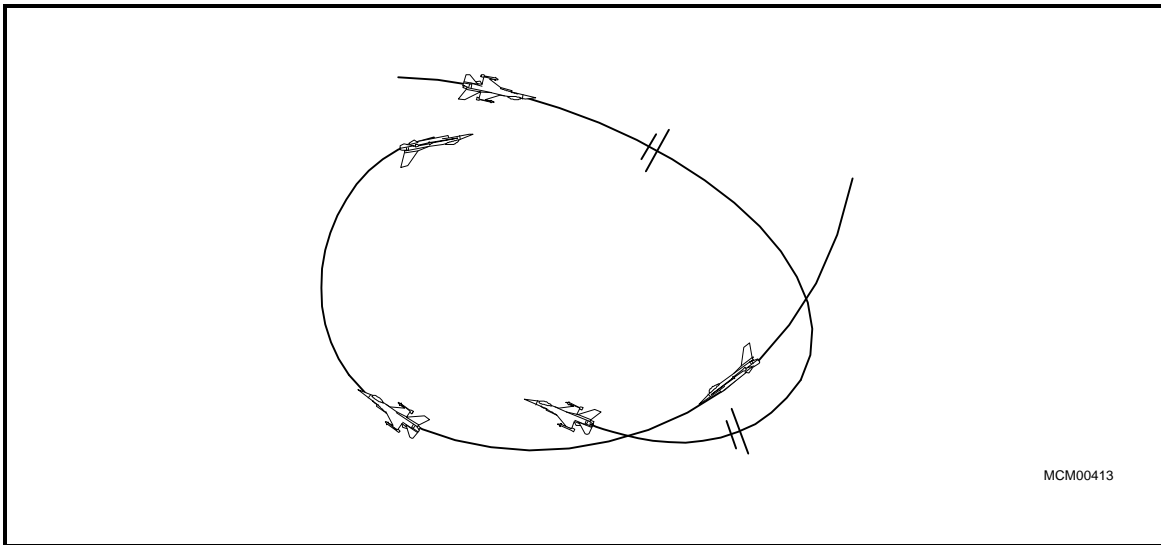
Common Errors:

- Not breaking on the limiter.
- Lift vector control (too high and you bleed energy, too low results in getting your nose buried).
- Poor IRMD.
- Poor timing of extensions/turns.
- Poorly timed out of plane maneuvers.
- Failure to recognize bandit errors.
- Losing sight.

#### 4.8.5. Continuous Turn Defense

This defense is much tougher to fly correctly than the check and extend, but gives you the best opportunity to survive in an air-to-air arena which involves radar missiles and all-aspect IR missiles. The basic principle is to maintain an energy state where your aircraft performs best, creating angles and forcing the bandit into making a mistake. As with the check and extend, initially you need to turn (Figure 4.39) on the limiter as long as the bandit moves forward on your canopy. When the bandit's nose is off get the power back into full AB, and assess your energy. Typically you'll be around 350 kts when the bandit enters your turn circle. Get your lift vector slightly below the horizon so God's G can help you maintain energy and continue your pull. Ease off of the limiter and hold 330-350 kts. 330 kts will optimize your turn rate and turn radius. Continue to monitor the bandit! His flight path should take him slightly outside yours, but not past your extended longitudinal axis. As long as he is not in a position to employ missiles you can keep it in AB, but as soon as the bandit rates his nose around you'll have to use IRMD.

If the bandit bleeds all his energy in the first turn, and continues to pull maximum G, he may stagnate. You should feel pretty good at this point, but remember it is the bandit's decision to stay "stuck in lag" not yours, and if he wants/ knows how to get out of it he can. However, if he is experienced, when he recognized that your game plan was a continuous turn he probably eased off his turn to preserve both energy and range. Eventually he will threaten you enough to force you out of AB, and rate his nose to threaten you with the gun. When this happens it's time to give up some of your airspeed and turn to create angles and closure problems. The bandit will have to reposition to maintain control, and as soon as he does plug in the AB, and ease off your turn to capture the rate that will not deplete any more airspeed. When the bandit threatens you again, repeat the process. If the bandit makes no mistakes you'll eventually have to transition to a guns defense. If he does he may overshoot to a scissors, stack, or even a reversal.



**Figure 4.39 Continuous Turn Defense**

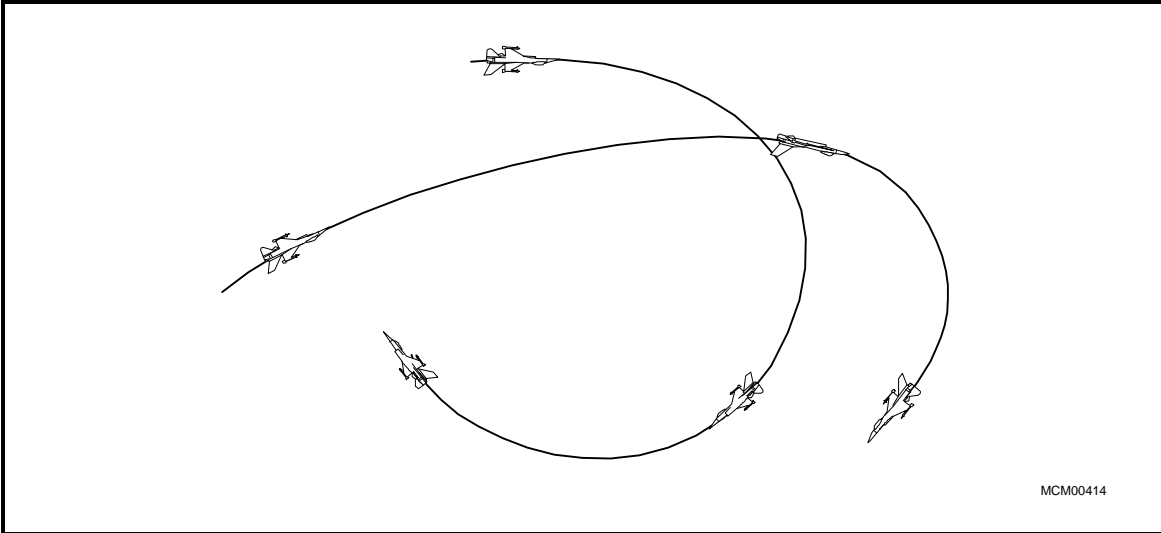
Common Errors:

- Lift vector control.
- Poor IRMD.
- Poor energy management.
- Failing to recognize bandit errors.
- Late transition to a guns defense.

Whether you elect to do a check and extend defense or a continuous turn defense the goal is to force the bandit to make an error that you may capitalize on. There are several keys to assessing the bandit's energy state. If the air is right to produce contrails, and the contrails are coming off the bandit's wing tips, his energy is high. If they are coming off of the fuselage, then the bandit's energy is low. The best indicator of the bandit's energy is nose rate. Couple this with bandit maneuvers and you're on you can capitalize his errors. If the bandit bids low to arc you across the circle; a small bid down by the bandit can easily be countered by matching him. This will not only take away his turning room, but will aid in keeping your energy up. If the bandit makes a large bid down to cut across the circle, chances are his energy is low. You could match this move also, but that may result in moving the entire fight to the bottom of the area and give the bandit a possible snap shot. If you know his energy is such that he does not have over the top air speed, and you do, use the vertical. This can be extremely risky, especially if you miss-judge his energy and he has range. Another option is to place your lift vector slightly above the bandit and pull on the limiter. This will keep you out of plane, increase angles, and possibly send this fight neutral or offensive for you. In most cases, your defense will be a combination of both the check and extend, and the continuous turn. Proper application of both will prolong your survival and give the bandit more opportunities to create an error for you to capitalize on.

#### 4.8.6. Guns Defense

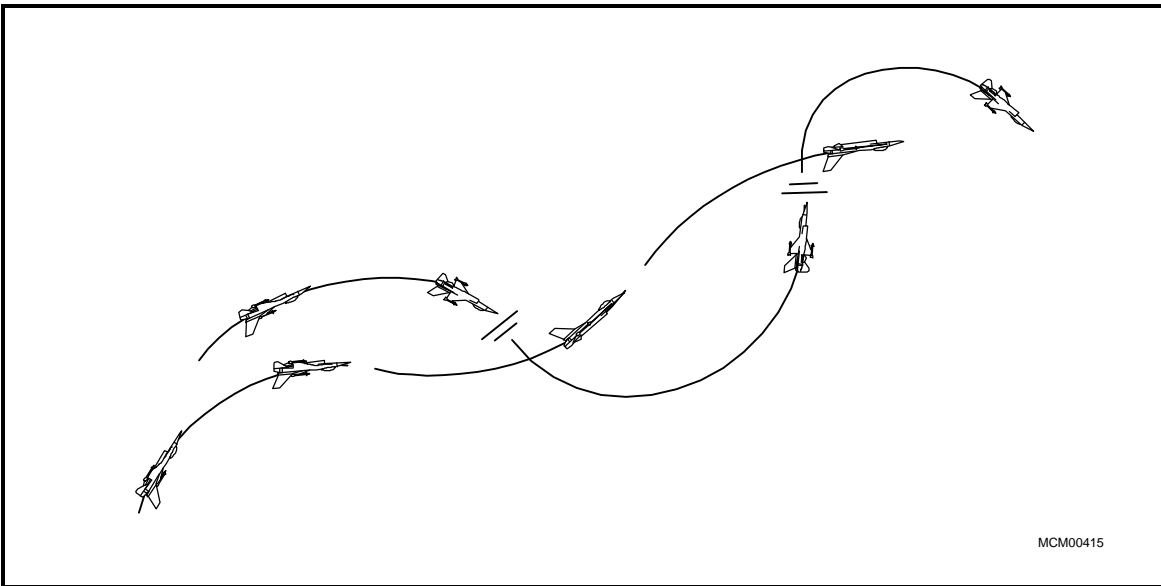
If you're in a gun fight, defeating the gun shot should be at the top of your thoughts (Figure 4.40), but the missile is still a threat at close ranges so don't forget IRCM. For the bandit to get a valid guns track he must be in plane, in range, and nose in lead. As a general rule give the bandit what he doesn't want. (i.e. if he tries for lead give him lag and visa versa)



**Figure 4.40 Guns Defense**

At the "fight's on" your first move must be out of plane. Rotate your lift vector down (about 20°) in the direction of the bandit and pull as if your life depended upon it, and watch the bandit. How long you pull depends on the bandit, but be extremely careful not to bury your nose and become predictable. He has only two options: make a bid to lag, or pull lead for a gun shot.

If the bandit makes a bid to lag you'll see an aft movement on your canopy, and his nose come off of you. Your move can either be to keep turning to try and get him to stagnate, or nose counter to create closure problems. If you continue to turn be prepared to jink (Figure 4.41) as the bandit rates his nose to you. If you nose counter right off the bat, keep in mind that even though you're creating closure immediately, the bandit may still bring his nose through you in his next reposition.



**Figure 4.41 Guns Jink**

If initially bandit pulls lead for a gun shot you'll see forward movement on your canopy and the bandit's nose rating forward. (If you see belly you're too late on your move.) What you need to do is roll underneath or nose counter over the top in a worm defense. The bandit wants lead so give him lag.

Basically both moves are similar as you're doing an unloaded roll to change your direction of flight. As you jink it is important to keep some energy on the jet. AB is probably out of the question or you'll offer the bandit a missile shot. So maintain mil power, flare when appropriate, and try to keep a slight downward vector of about 10°-15°. This will help you keep about 200 kts and ensure you still have the energy to jink. The unload at slow speed seems to take forever so really slam the stick forward and roll quickly the other direction. If your vector is slightly down then repositioning your lift vector in the opposite direction is quicker if you roll underneath. But don't try it with less than 1000' of altitude until the floor in case you make an error. It is best to use a combination of both to avoid predictability. It is critical is to maintain the pull for a few seconds following each move to ensure you are getting out of the bandit's HUD.

Your first goal is to give the bandit a closure problem, forcing him to reposition, and get his nose out of sync. The closure problem will develop by the bandit continuing to pull lead with each of your jinks. He will subsequently fly a shorter path than you, creating lots of closure at short range. You'll notice this by the size of his aircraft, and a nose off reposition. If his nose is in plane, get him out of sync. If his nose is out of plane, try to keep him in phase with you by putting lift vector on.

If during your jinks you lose sight of the bandit, do not go into a single direction death spiral. If you jink and don't pick him up, then jink again. Search inside and slightly high first then high above. If no tally, jink again and search the same pattern.

The bottom line is, if the bandit never makes an error, or you don't capitalize on those he does make, you'll have problems.

Common Errors.

- Mis-timed jinks (Failure to accurately assess the bandit's range, and nose position).
- Jinking up.
- Loaded rolls (up and you bleed energy, down and you get your nose buried)
- Lose sight.

#### 4.8.7. Reversals

When does the opportunity for a reversal present itself? Throughout the engagement you need to constantly assess the bandit's range, closure, and heading crossing angle. The time to reverse is when the bandit will pass close aboard at a high line of sight and high HCA. This is purely a judgment call on your part. But for a general rule of thumb you can assume close aboard is less than a turn radius. As for high LOS rate and angles, well that depends on the range and the capability of the bandit's aircraft. This all may sound fuzzy, but there is no clear cut formula for when to reverse. However, when the time comes and you make the decision to go for it, you have to execute quickly and decisively or you're toast. The execution must be violent and on the limiter. If you think of nothing but pulling for the bandit's high six, you'll do fine. The decision to reverse is made before the bandit actually passes you, but is committed to fulfill the above requirements. At that instant, select full AB and pull to the bandit's high six. This pull initially is in the same direction that you were already turning since the bandit hasn't passed yet. As he passes by rotate your lift vector to continue towards his six. You want turning room, so don't put your lift vector on him, it has to be behind. This move will result in a limiter barrel role around his flight path, and in essence stopping your ground track while he flies by. The rate at which you roll your lift vector is solely determined by the LOS of the bandit as he passes. If it works, put your offensive hat back on. If it doesn't, more than likely you're now in a scissors or a stack. One word of caution—if you're having to waiver on your decision to reverse or not, don't. What you stand to lose is far greater than continuing with your defensive game plan.

#### 4.9. High Aspect BFM

When two aircraft turn toward a mutual head-on attack, they are positionally neutral; however, differences in aircraft performance, ordnance, and pilot abilities keep this from being a "neutral" fight. The assumption in high aspect BFM is both fighters have tally and have turned to point at each other.

##### 4.9.1. Objectives During High Aspect BFM

- Determine your advantage.
- Exploit that advantage into a positional advantage.
- Use offensive BFM to achieve a kill.
- Separate before becoming disadvantaged.
- If unable to separate, perform your best 1 v 1 defensive BFM.

##### 4.9.2. Options At The Pass

Your decision to stay and fight or to separate will be based on many considerations: fuel, ordnance, energy, mission, etc. If your decision is to separate, then the initial pass is usually the best opportunity for a separation. If your decision is to stay and fight, then attempt to gain turning room laterally and vertically prior to the pass. If the bandit allows you to gain turning room prior to the pass, lead turn him to gain a position of advantage. If the bandit does not allow you turning room at the pass, your options are: extend, vertical up, vertical down, pitch, slice, or lateral turn.

###### 4.9.2.1. Extend

You may extend straight through in order to gain turning room and/or energy. This will force a wider fight which will allow the use of all-aspect ordnance. If the bandit is capable of a high turn rate, it will be difficult for you to gain sufficient turning room prior to the bandit threatening you. However, if your energy is low at the initial pass you may have no option but to extend.

###### 4.9.2.2. Vertical Up

If you pull straight up at the pass your turn rate will be lower and turn radius will be larger during the first half of the loop. As you maneuver in the vertical, you will become slower, more predictable, and be more exposed to the look-up missile threat. As a general rule, unless the bandit does not have the ability to maneuver in the vertical, going up at the initial pass is not advisable.

###### 4.9.2.3. Vertical Down

If you pull straight down at the pass, your turn rate will be higher and turn radius, dependent upon airspeed, may be smaller. If you are at corner plateau velocity, a limiter split-S will be the quickest way to turn 180°. The disadvantages of the split-S are that the maneuver is physically demanding, and the tally is extremely difficult to maintain. Additionally, if you are above corner plateau velocity your turn radius can become very large.

###### 4.9.2.4. Pitch

If you use a pitch at the pass, the effect on your turn rate and turn radius will be similar to the vertical up, but to a smaller degree. The advantages/disadvantages of a pitch are the same as the vertical up; however, a pitch may be used to control excessive airspeed and slow to corner plateau velocity prior to performing a follow-on maneuver such as a lead turn or slice.

###### 4.9.2.5. Slice

If you use a slice at the pass, the effect on your turn rate and turn radius will be similar to the vertical down, but to a smaller degree. Controlling airspeed to minimize turn radius is very important. A slice at the pass is a good compromise to gain some benefits of radial G and still maintain tally. A 425 KCAS max AB slice, with approximately 10° nose low, will allow a 7 - 8 G sustained turn for the first 90° of turn. After that, modulate G to control nose position and airspeed.

#### 4.9.2.6. Level Turn

Generally, a level turn does not take advantage of radial G and is inefficient BFM. However, turning level offers the best opportunity for maintaining tally and will help bleed off excessive airspeed (above 500 KCAS) until a transition to a slightly nose low attitude is desired.

#### 4.9.3. One Circle Fight

A fight can be forced one circle by you or the bandit. A one circle fight will be a closer fight and deny all-aspect missile employment.

Against a bandit where you have a turn rate and turn radius advantage (F-4) a one circle fight will allow you to recognize a quick positional advantage (Figure 4.42). At the pass, turn in a nose low slice away from the bandit to kick him across your tail. You must control your airspeed prior to the pass to avoid getting above corner plateau velocity and increasing your turn radius. With your turn rate and radius advantage you will recognize a positional advantage after 180° of turn. After the first 180° - 210° of single circle turn, you must choose one of two immediate actions: (1) extend for energy prior to turning toward the bandit or (2) reverse the turn direction immediately and start a lead turn inside the bandit's turn circle. As you roll out of an initial right turn, the bandit will be at 12:30 to 1:30 with a right to left LOS rate. Your airspeed should be  $300 \pm 25$  KCAS if a maximum G turn was accomplished. The next several seconds can be used to unload for energy if airspeed is low or begin a lead turn inside the bandit's turn circle. The turn should begin prior to the pass, but with a constant airspeed pull. Maintain over the top potential. If the bandit remains level, two to four passes may be required to align fuselages enough for a shot. If he recognizes his energy advantage, he may attempt to exploit the vertical. If the bandit zooms, immediately evaluate your energy in light of the aggressiveness of his maneuver. If his energy is significantly greater, you may want to extend momentarily before pursuing in the vertical. From this point, high to low lead turns as the bandit comes down the back side of his loop will result in fuselage alignment. From this position of advantage you can employ offensive BFM to develop a shot opportunity.

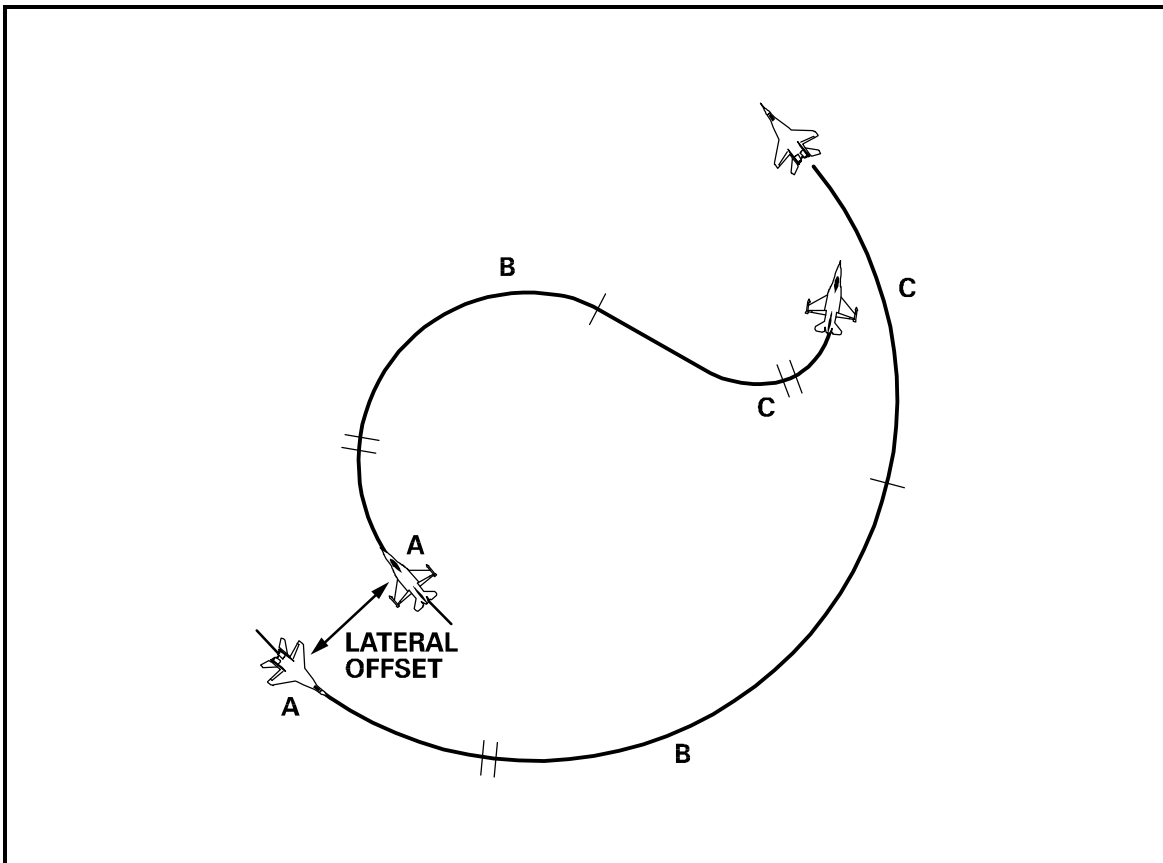
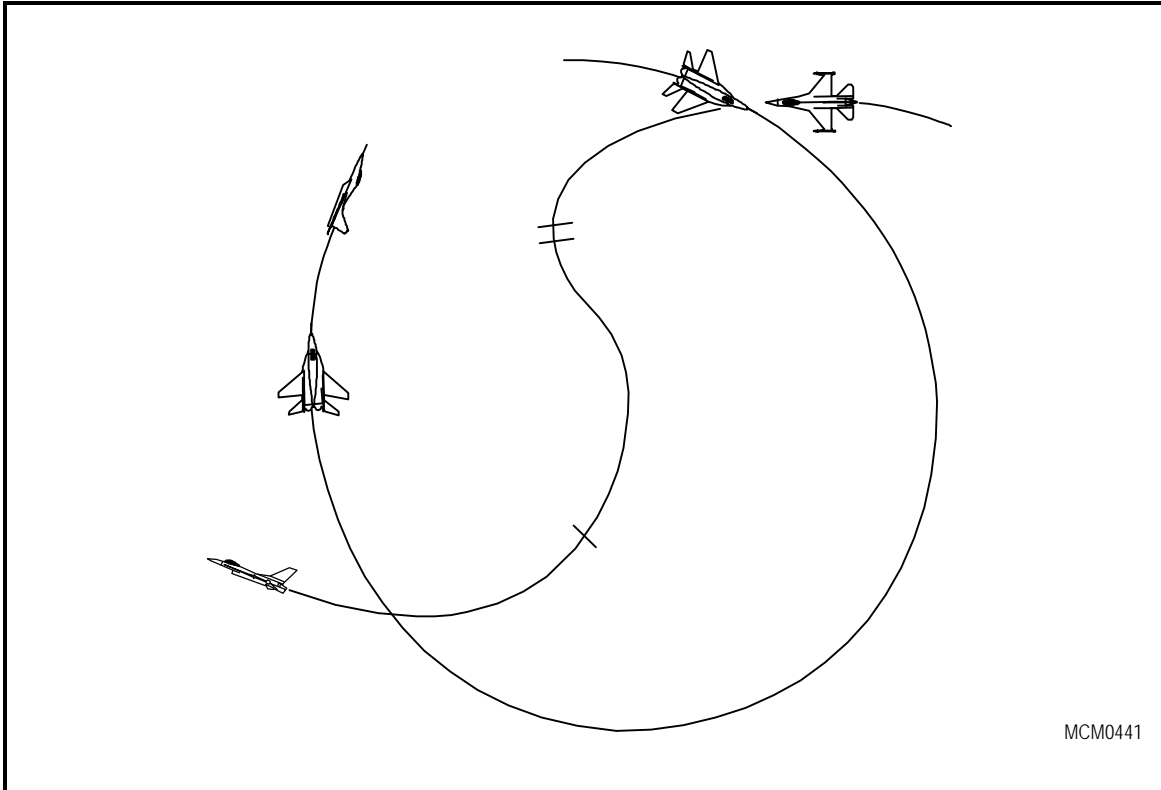


Figure 4.42 One Circle—Turn Rate/Radius Advantage

Against a bandit where you have a sustained turn rate advantage, you may or may not achieve a positional advantage after the initial turn. If the bandit uses his instantaneous turn capability, you may meet him at high aspect at the next pass (Figure 4.43). In this case, you will have an energy advantage at the second pass. The key to this fight is patience. If he continues to turn hard, his turn rate will decrease. However, the bandit's turn radius will also be smaller which may allow him to turn inside your turn circle. On subsequent passes, you will realize a positional advantage if you continue to lead turn the bandit. Exercise care to not grossly lead turn out in front of the bandit. A low energy bandit will have a smaller turn radius, but will not be able to follow you into the vertical. If the bandit does not use his instantaneous turn rate capability you will have similar energy but a positional advantage after the first turn. This fight will be similar to the discussion in paragraph (1); however, patience is still the key since the bandit has a good instantaneous turn rate capability.



**Figure 4.43 One Circle—Turn Rate Advantage**

Advantages to a One Circle Fight:

- Allows a quick positional advantage against a poor turning bandit.
- Unpredictable move at the pass.
- Keeps you inside the bandit's all aspect missile minimum range.

Disadvantages to a One Circle Fight:

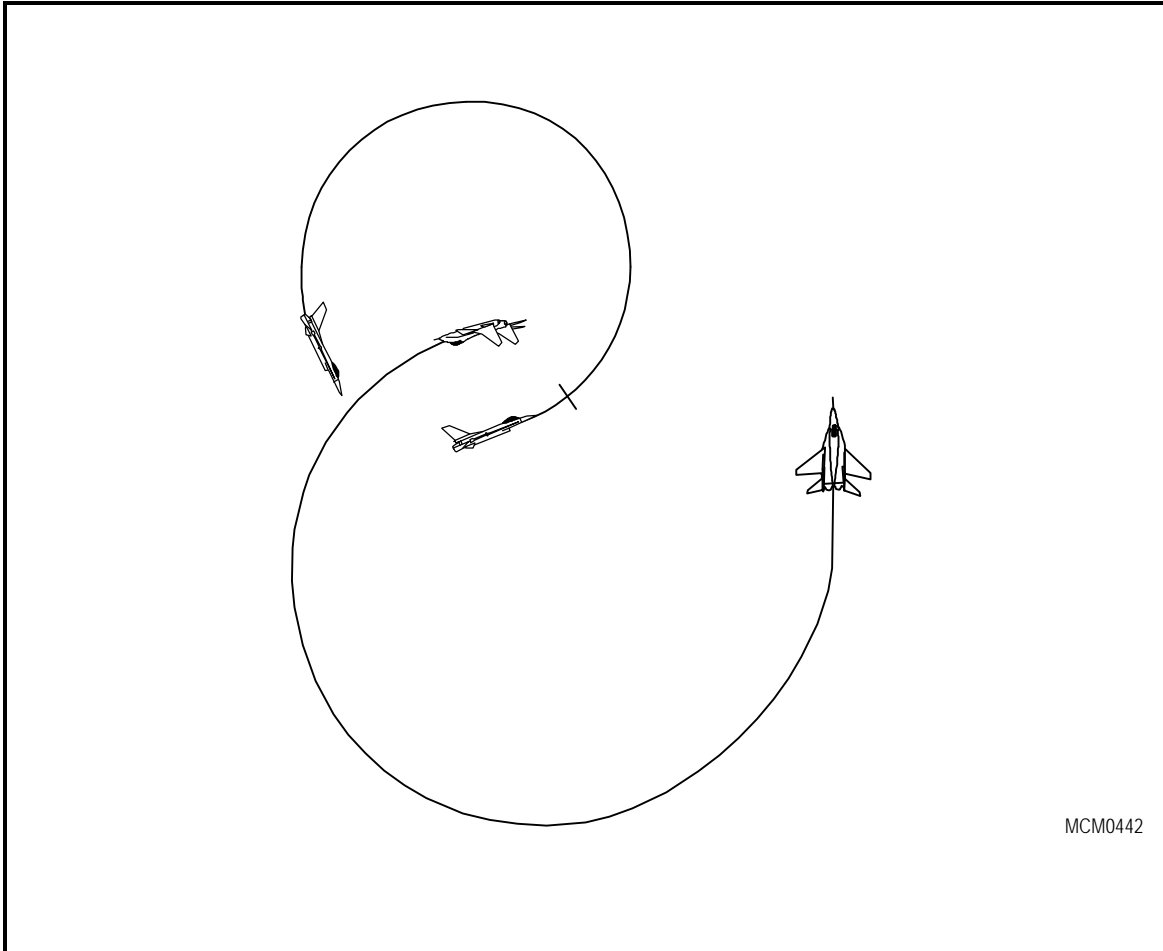
- Forcing a one circle fight gives up the lateral turning room between you and the bandit.
- Requires a very hard, energy depleting turn to be effective.
- Normally doesn't allow F-16 AIM-9 front aspect employment (inside minimum range).

#### 4.9.4. Two Circle Fight

If both fighters attempt to lead turn, then a two circle fight will result. A two circle fight will be a wider fight and may allow fleeting all-aspect missile shot opportunities.

Against a bandit where you have a significant turn rate and turn radius advantage, a two circle fight should allow you to achieve a positional advantage after the first turn (Figure 4.44). At the pass attempt

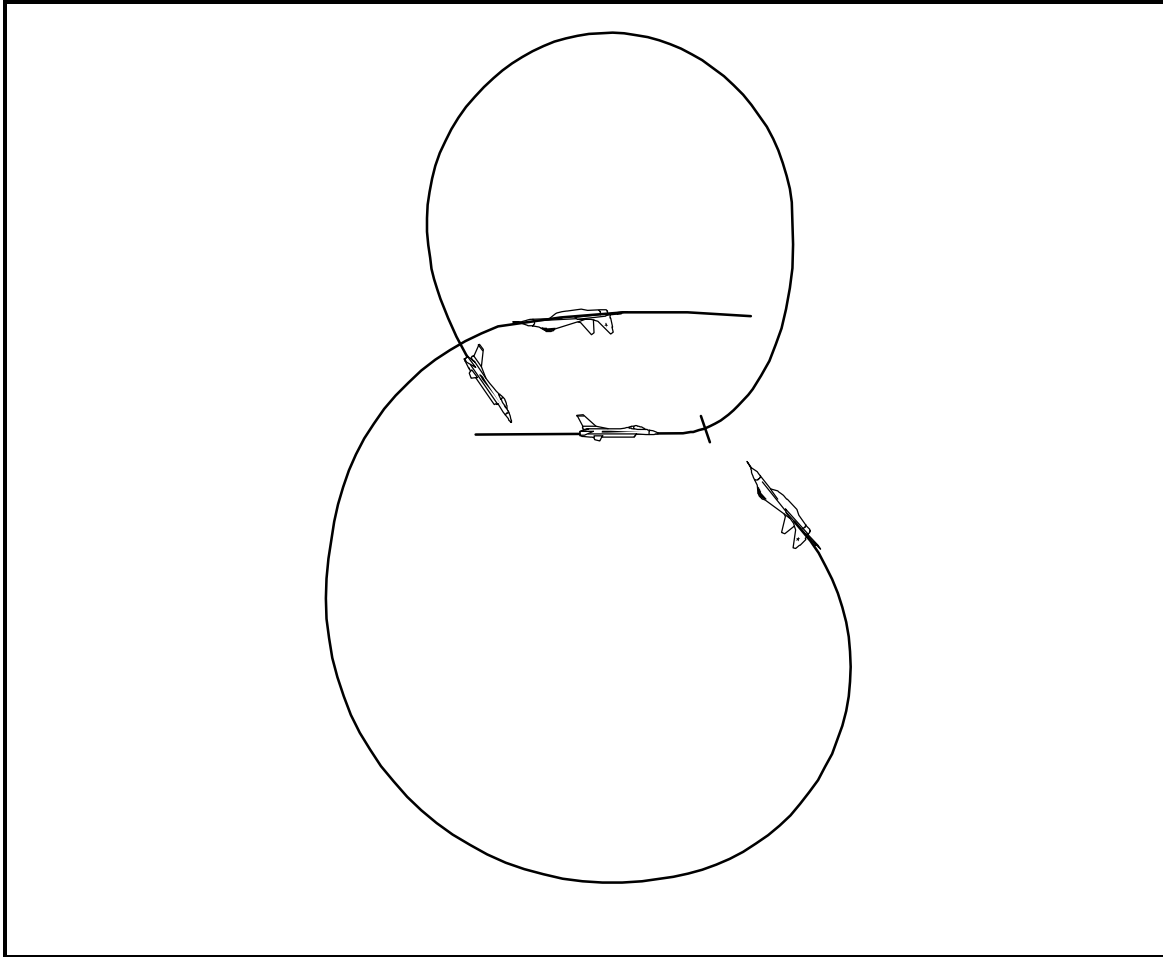
to have 425 - 475 KCAS, select max AB and turn using a nose low slice to increase your turn rate advantage. You must control your airspeed to keep from increasing your turn radius but ensure you maintain a good sustained turn rate (350 - 400 KCAS is a good airspeed range). This first turn may provide an all-aspect missile opportunity. Patience is important. Concentrate on lead turning the bandit at every pass. As you begin to recognize a positional advantage it is important to maintain over-the-top airspeed until the bandit has lost over-the-top capability. If the bandit goes pure vertical, ensure you have sufficient airspeed (within 100 KCAS of his airspeed is highly desired) then go up and look for a low to high lead turn.



**Figure 4.44 Two Circle—Turn Rate/Radius Advantage**

Against a bandit where you have a sustained turn rate advantage, you may or may not achieve a positional advantage after the initial turn. If the bandit turns hard, you should pass high aspect again (Figure 4.45). At the initial pass, begin a nose low slice to increase your turn rate as described above. Upon roll out, prior to the second pass, a fleeting front aspect AIM-9 opportunity may occur. Nose position vs energy maintainability will dictate the airspeed for both fighters at the pass. If the bandit expends all his energy to point at you, the next pass will be high aspect but you will have an energy advantage. On subsequent passes, an energy advantage and positional advantage will result from lead turning and energy management. As you recognize an offensive position, you must control your airspeed. The bandit will be slow and may transition to a one circle fight on the second pass due to this low energy state. Additionally, be aware that the bandit's turn radius will be small due to his slow airspeed. When you see the bandit's nose on the inside of your turn, but not pointing at you, he is low on energy. You now have exclusive use of the vertical. You can transition to the pure vertical and drive to the bandit's six o'clock.





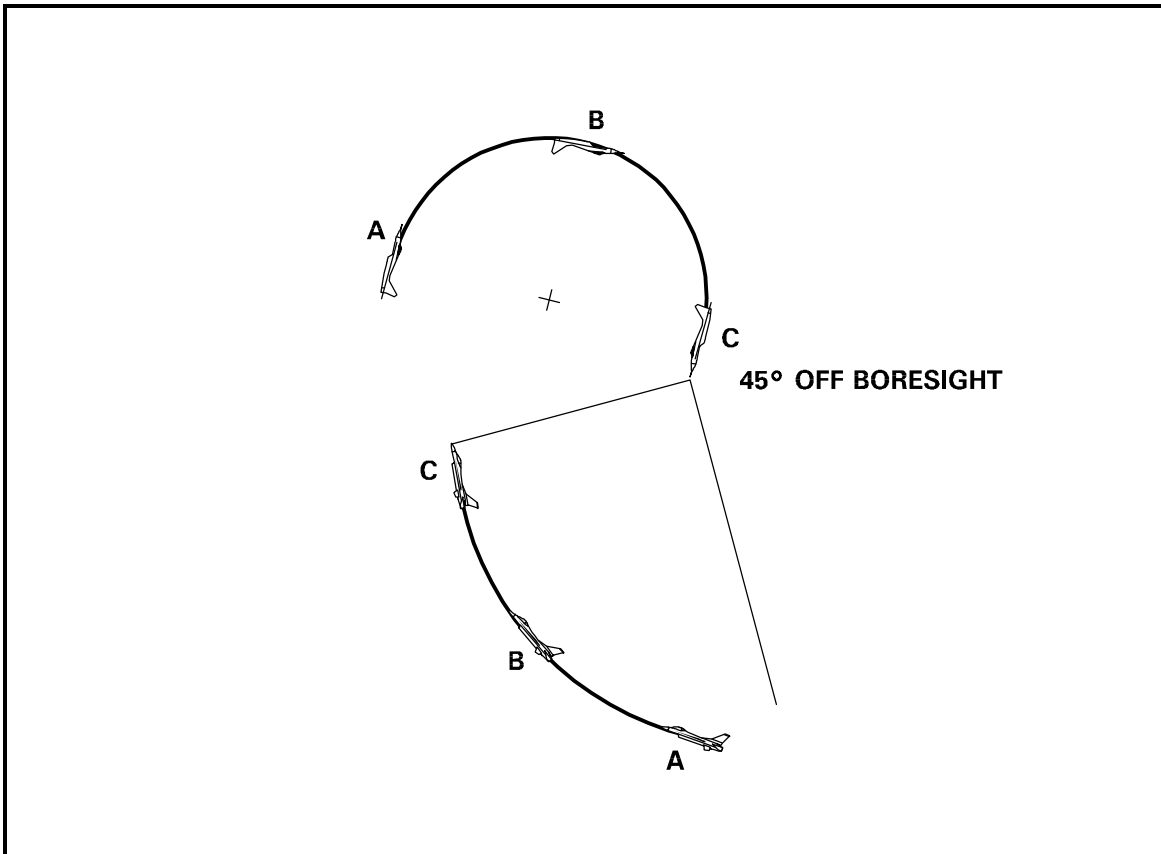
**Figure 4.45 Two Circle—Sustained Turn Rate Advantage. (Energy advantage at this pass)**

#### 4.9.5. High Aspect BFM Game Plan

There may not be a single best way to fight any individual bandit and fighter pilots will always be required to make decisions in the air based on the situation. But it is important to have a sound game plan that will work in most situations before you get to the initial pass. The F-16 has an outstanding instantaneous and sustained turn capability. Additionally, the F-16's hands-on avionics and small size give it an advantage in a visual fight.

To put the game plan together approaching the merge, attempt to gain turning room laterally and below the bandit. As you enter the bandit's turn circle you will begin to see rapid movement aft on your canopy. Begin a low-to-high lead turn. If the bandit turns into you this will force a two circle fight. This also means you are turning in the shortest direction to maintain tally. At the pass, overbank to get your nose below the horizon to take advantage of radial G. Use a maximum G pull until low corner plateau velocity (350 - 400 KCAS is a good window). Analyze the bandit's energy by evaluating his nose rate and movement across the horizon and transition to a sustained turn rate pull. Set up the next pass to be the low man. At the bandit's turn circle, when you begin to recognize definition on his aircraft (approximately 3000'), begin a low-to-high lead turn, overbanking to use radial G, if possible. Do **not** lose tally or go belly-up. Continue this plan until you achieve a position of advantage. Take shots of opportunity but never give up all your energy for one shot unless it guarantees a kill. It is also important to maintain over-the-top airspeed until the bandit has given up his over-the-top capability. Even with equal performing aircraft, if you lead turn and use radial G to your advantage, you will gain a positional advantage. When you have the positional advantage, transition to offensive BFM and kill the bandit.

Off-boresight capabilities must be taken into consideration (Figure 4.46). Even today's technology allows air-to-air missile employment without being in pure pursuit. As technology improves (increased off-boresight missile capability and/or improved ACM modes and helmet-mounted sights), an adversary may be a threat well before achieving pure pursuit.



**Figure 4.46 Off-Boresight Capable Adversary**

#### 4.10. Air Combat Maneuvers (ACM)

ACM normally involves coordinated maneuvering between two fighters employing BFM to kill, defend or separate from one or more bandits in a visual merge. The engaged phase can be the outcome of the intercept phase or an undetected bandit entry, and is the highest risk phase of an air-to-air engagement. Distinct roles, or an "ACM Contract," must be briefed and established between the two fighters prior to any flight with the potential for ACBT in order to assure effective ACM. This contract defines "engaged" and "supporting" roles. Disciplined execution of these roles is critical for survivability and lethality. Any break down in the established "ACM Contract" can lead to undesirable and disastrous outcomes! (i.e. Midair).

##### 4.10.1. ACM Objectives

- Develop proficiency in two-ship coordinated maneuvering.
- Teach specific engaged and supporting fighter roles in a visual fight.
- Develop enhanced situation awareness.

An F-16 is capable of rapid kills from an offensive start. Consequently, the role of the supporting fighter is not the same when his element mate is offensive as when the other F-16 is defensive. This adjustment in priorities resulting from the other F-16's positional advantage/disadvantage requires focused, concentrated training in the visual environment. There are four cornerstones to effective element employment: communications, formation integrity, flight discipline, and weapons employment.

#### 4.10.2. **Communications**

Calm, clear, and concise communications are vital for effective element employment. Each pilot must firmly understand MCM 3-1, Vol I brevity terms, unit standard terminology, and be able to use the correct terms at the correct moment in a fight. If the situation cannot be addressed using MCM 3-1 brevity or unit standard phrasing, use clear text to accurately describe your intentions or maneuvers. Proficiency in one's communications skill is gained only by daily practice and constant critique. The time to start improving your comm is not after the first "Break right" call. The planned cadence, comm procedures, and brevity terms that are expect to be used during the flight should be reviewed in the flight briefing to enhance their effectiveness. Shortening communications too much is a bad habit that fighter pilots need to avoid. Nonstandard radio terminology (i.e. lack of proper call sign), and excessive verbiage can cause confusion and misinterpretation at a critical time. This could result be fatal. Use full call signs when beginning radio transmissions to gain the attention of flight members requiring the information you have and allowing noninvolved flights to "tune out" your transmission. All missions (not just air-to-air) should focus on communications discipline!

As part of a fighting team, you will see situations develop quickly as you maneuver. As the bandit maneuvers you will have to communicate what you see in the most efficient way. As the wingman, you may have to tell lead what to do if you have tally and he doesn't. If your information isn't critical, your radio call should be descriptive and lead will use it to make decisions while maintaining control of the flight. When the flight is definitely threatened, a directive transmission is called for.

##### 4.10.2.1. **Directive Transmissions**

A directive call is required when a threat warrants an immediate reaction for survival. Directive radio transmissions must be prefaced by the call sign of the aircraft being addressed, i.e., "Viper One, break right!" After making the directive transmission "Viper One, break right," pause, look and see if lead is doing what was directed. If not, re-transmit the directive call. The priorities need to be placed on the execution of the directed action. All other mission tasks are secondary until the threat has been negated or defeated. The supporting fighter may be required to make a series of directive calls due to limited time. "Viper One, break right," "Viper One, jink now," "Viper One extend," if the supporting fighter has the tally and there is not time to describe the bandit's position without jeopardizing the safety of Viper One.

##### 4.10.2.2. **Descriptive Transmission**

Descriptive transmission are normally prefaced by the call sign of the aircraft doing the talking, (i.e. "Viper One, tally bandit, left 10, 5 miles, level.") When a directive action is required the descriptive comm must come after the directive transmission and action is taken. Then, describe why you made the directive call. The bandit descriptive call is important for it will allow Viper One, in this example, to acquire the tally and perform the proper BFM to defend himself. The bandit call has been standardized into the following format, which should always be used:

- Call Sign.
- Type aircraft, or threat (Bandit /Bogey).
- Left or Right (side of aircraft.)
- Clock position.
- Range.
- High/ Low/ Level.
- Amplifying remarks.

Here's an example of the above format: "Viper Two, bandit, right 2, 3 miles, high." A modification of this format is used to follow up a directive call if your element mate is under attack. Here's an example: "Viper One, break, right," pause, as the directive action being taken, then continue with the descriptive comm: "Bandit, right, 5, 9,000', level." In this case, the position of the bandit is described with reference to the aircraft under attack. Continue descriptive comm until the engaged fighter is tally. Sometimes subsequent descriptive calls may include the word "continue." This informs all flight

members that the only reaction required is the maneuver that is being performed. For example Viper One calls, "Viper flight, hook right," "Viper One, bandit, right 4, 5 miles, slightly high, continue right."

#### 4.10.3. **Formation Integrity**

Formation integrity is an integral part of all element maneuvering. In the ACM environment, formation integrity allows both the engaged and supporting fighters to maneuver synergistically to defeat the bandit's attack. Mutual support and formation integrity are critical to success. The engaged fighter must do his best one versus one BFM to kill or survive the bandit's attack, while the supporting fighter maneuvers to kill the bandit or support the engaged fighter based on the criteria defined by the flight lead.

#### 4.10.4. **Flight Discipline**

Flight discipline is an important factor effecting the success of fighter employment. This requires adherence to clearly defined responsibilities and decisions based on the flight lead's overall game plan and philosophy of employment. The flight contract is fulfilled by executing your duties based on the flight lead's plan (i.e. set of assumptions and guidelines). The flight lead can assess the success of the plan or failure and make changes to the plan. Obviously, no pilot should do anything to place himself or his wingman in a defensive situation. However, changing or ignoring the flight lead's directions based on personnel preference is unacceptable!

#### 4.10.5. **Weapons Employment**

Knowledge of your weapon system capabilities and limitation will allow you to make accurate decisions concerning weapons employment. You must apply your BFM skills to maneuver to a Weapons Employment Zone (WEZ) then effectively put weapons on target to kill. The status of your element mate and yourself will be affect your decision to maneuver immediately to a WEZ, defend, or reposition.

#### 4.10.6. **Engaged and Supporting Fighter Contract**

Most units have "standards" that provide essential, clear, and unique procedures to: ensure success in training and combat sorties, minimize briefing time, clarify ambiguities, and establish a common point of reference. These "standards" need to be fully understood by every pilot in that unit. An effective "ACM Contract" assigns responsibilities between two aircraft that are essential to take full advantage of the element's capabilities during an air-to-air engagement. In the flight briefing it's the flight lead's responsibility to ensure complete understanding of the "ACM Contract." The division of responsibilities serves two basic purposes: killing the bandit and ensuring element survival. The ingredients required for successful execution of the "Contract" is mutual understanding of the game plan and a correct balance of communication, mutual support, executions of responsibilities, and weapons employment.

##### 4.10.6.1. **Engaged Fighter**

During offensive maneuvering there can only be **ONE** actively engaged fighter (fighter that is maneuvering in specific relationship to the bandit) at a time. While defensive, the bandit will choose who is the engaged fighter. In a dynamic environment, such as air-to-air, the roles may change rapidly from one to the other several times. Flight members **MUST** fully understand their responsibilities and how they will be handed off, (whether by radio calls or aircraft maneuvers).

Engaged Fighter Responsibilities:

- Maneuver to kill the bandit (offensively) or negate the bandit's attack (defensively) in the minimum time. Fly your best offensive/defensive BFM.
- Clear the supporting fighter to engage if he is in a better position to shoot, or if defensive and the engaged fighter is not safely outside the supporting fighter's weapons FOV or target debris would be factor, again clear the supporting fighter to shoot.
- Keep the supporting fighter informed of intentions, capabilities, and future tactical plans.

##### 4.10.6.2. **Supporting Fighter**

As the supporting fighter you may have to perform two or more tasks/ responsibilities at the same time. Time sharing between the tasks at hand is required to effectively support the engaged fighter. The time allowed to perform a given set of tasks will be scenario dependent. As a rule of thumb (ROT) the

supporting fighter needs to first maneuver to sanitize the area about the fight through visual (tally/visual) and electronic means (radar, GCI, RWR). Next be prepared to commit against any bandit that threatens the element, whether offensively or defensively. Lastly, maintain a high situational awareness to direct the egress in a safe direction.

Supporting Fighter Responsibilities:

- Maintain visual and strive for tally.
- Inform engaged fighter of posit (potential for mid-air in the ACM environment makes this extra comm important)
- Sanitize the area about the fight through visual and electronic means (check your own six).
- Maneuver to avoid the fight and gain or maintain entry parameters on the bandit.
- Employ ordnance if the bandit is in a WEZ, consistent with the flight leads game plan, and without compromising the engaged fighter's safety.
- Engage other bandits that are a factor to the element and keep the engaged fighter informed.
- Maintain overall situational awareness to include area orientation, fuel, and exit avenues.
- Direct the egress.

#### 4.10.7. **The Flight Lead/Wingman Relationship**

The previous discussion does not equate engaged and supporting roles with leader and wingman positions; this is intentional. Our tactics are designed to allow the best positioned fighter to engage the bandit offensively. While on defense, the driving factor for whom is engaged will obviously belong to the bandit. This should not imply break down within the basic flight lead/wingman responsibilities. The flight lead still has the ultimate responsibility for mission accomplishment and flight survival. The flight lead also makes the decisions about whether or not to engage, what tactics will be used, and who will do the engaging or separating. While the wingman is engaged, the flight lead supports him but retains the authority to direct the engagement, to terminate the engagement, to assume the engaged role, or to revert his wingman to the supporting role.

The engaged/supporting responsibilities work effectively in most 2 v 1 situations; however, when the contract breaks down, the flight may present a danger to itself. Confusion of roles is the most common problem. Two fighters, each thinking they are engaged, can easily end up occupying the same airspace. For this reason, flight and element leads will brief engaged and supporting responsibilities, maneuvering deconfliction, role changes and desired engaged communications prior to any flight with the potential for ACBT maneuvering. Element or wingman deconfliction subsequent to a blind call or planned loss of sight tactic will be briefed for any planned intercept or ACBT flight where more than one element or more than one fighter may be maneuvering against the same bandit or bandits. Elements/wingman will not begin visual offensive maneuvering against an adversary unless cleared to engage by the flight/element lead. Formal squadron/wing standards covering this requirement are adequate if all flight members are fully aware of the standards.

#### 4.10.8. **2 V 1 Offensive Visual Maneuvering**

The visual phase of maneuvering is really the "meat of the mission" where ACM is concerned. The tactical intercept gets the element to the merge, usually in an offensive position. Once there, our two airplanes must work together in accomplishing the primary goal which is to destroy the enemy ASAP, while maintaining mutual support. There must be complete understanding between the leader and wingman of their obligations towards one another. This understanding forms the basis of the contract which governs two-ship visual maneuvering.

The termination of the intercept phase is when the element arrives in position to begin visual maneuvering against the bandit. It is imperative that the element establish roles ASAP. The flight lead should transmit his intentions (i.e. "Viper 1, engaged, nose 3 miles.") This not only anchors the fight but establishes the engaged and supporting roles. If the bandit detects your attack and maneuvers to counter it, the tactical wingman may be in a better position to engage. If so the flight lead should direct the wingman to engage, (i.e. "Viper 2, cleared to engage bandit nose 3 miles, press.")

The engaged fighter needs to perform his best one versus one BFM, place the bandit in a WEZ as quickly as possible, and employ ordnance to kill the bandit. If the bandit negates your attack, continue to perform BFM forcing the bandit to react defensively and remain predictable. If you lose the offensive (i.e. neutral), due to bandit reaction, communicate this to the supporting fighter ASAP.

The supporting fighter needs to pick-up the supporting role, perform supporting fighter responsibilities, and setup the support structure. To set up the support structure the supporting fighter needs to off-set himself from the fight both horizontally and vertically. Fly BFM through the bandit's TC while lagging the engaged fighter. Then extend past the fight. Ensure the afterburner has been selected to maintain 450 knots or greater and extend through the fight arena quickly build needed separation. No matter which plane you merge with the fight, stay there and continue to split plane in that direction, to visual constraints (i.e. if already high above the fight, stay there and not on or near the horizon). Maintain sight of the fight by placing it at your 7 - 9 o'clock or 5 - 3 o'clock whichever way is easiest to maintain sight with the fight once to the outside of the fight. Roll out wings level and extend for about 5 - 10 seconds and then check back into the fight with 4 - 6 G's. Be sure not to arc in a climbing turn since this will not allow you to gain the desired separation from the fight and will highlight you to the bandit. Fly straight lines and check turns to achieve your goal range of 2 to 3 miles with at least a 4000 foot altitude split between you and the fight. This range and altitude split from the fight will allow the supporting fighter time to radar and visually sanitize, and preserve maneuvering room for a shot of opportunity or a role change. Additionally, this position will make it hard for the bandit to acquire the supporting fighter and threaten him. Bandit maneuvering, visual acquisition, and environmental conditions must be taken into consideration.

Never place yourself in a position where you could become defensively engaged with the bandit that your flight member is engaged with (i.e. allow the bandit to point at you aft of your 3/9 line). That will not support killing the bandit and may get you killed. To avoid this put yourself in a position that will make it hard for the bandit to acquire you (split plane). Continue to maneuver away from the fight and sanitize the area for as long as the bandit's turn rate will allow. Visually confirm that the area around the fight is free from other bandits. A good technique is to first focus on an object at range (such as a mountain, or cloud). From there do a sector scan looking not for a specific aircraft, but movement. Force yourself to search not only along the horizon but high 12 and deep 6 o'clock as well. The radar should be in ACM with Slewable selected and biased to the outside of the fight or 20-mile scope minimum, with the el-strobe biased in the direction of the expected threat. After that volume of airspace has been sanitized, you are going to have to change the el-strobe to sanitize the remainder of the airspace. Listen closely to GCI for threat calls and sanitize that avenue of approach accordingly. Do not lose sight of the fight in the process. Time share between the supporting tasks is a must. As the bandit's extended 3 - 9 line approaches your jet (beam plan form), start a turn back into the fight to place it at left 10 or right 2-O'Clock, whichever way is easier to maintain sight. A bandit that is aware and maintains the tally on both fighters may fight the fighter in front of him as opposed to defending against the fighter at his 6-O'Clock. As the supporting fighter, you must ensure that the bandit doesn't engage you and force you to react defensively. The bandit's nose generally will telegraph his intent. The engaged fighter can also help by informing the supporting fighter of bandit maneuvers. If the bandit stops turning and points at you, maneuver to deny a WEZ. The range you are from the bandit will dictate either staying in the beam or checking into him to make it a 180 degree pass. ***Avoiding the engaged fighter with an altitude delta, as you extend through the fight, cannot be overemphasized.*** Power should be back and you should expend chaff and flares as needed. The bandit's extension towards you should provide a shot opportunity for the engaged fighter. If not, then continue with your supporting duties. However, if the bandit continues to turn defending himself against the engaged fighter, it should, based on range and aspect, offer a shot of opportunity, or a position from which an entry into the fight can be made if the engaged fighter needs your help.

#### 4.10.8.1. Areas to Avoid

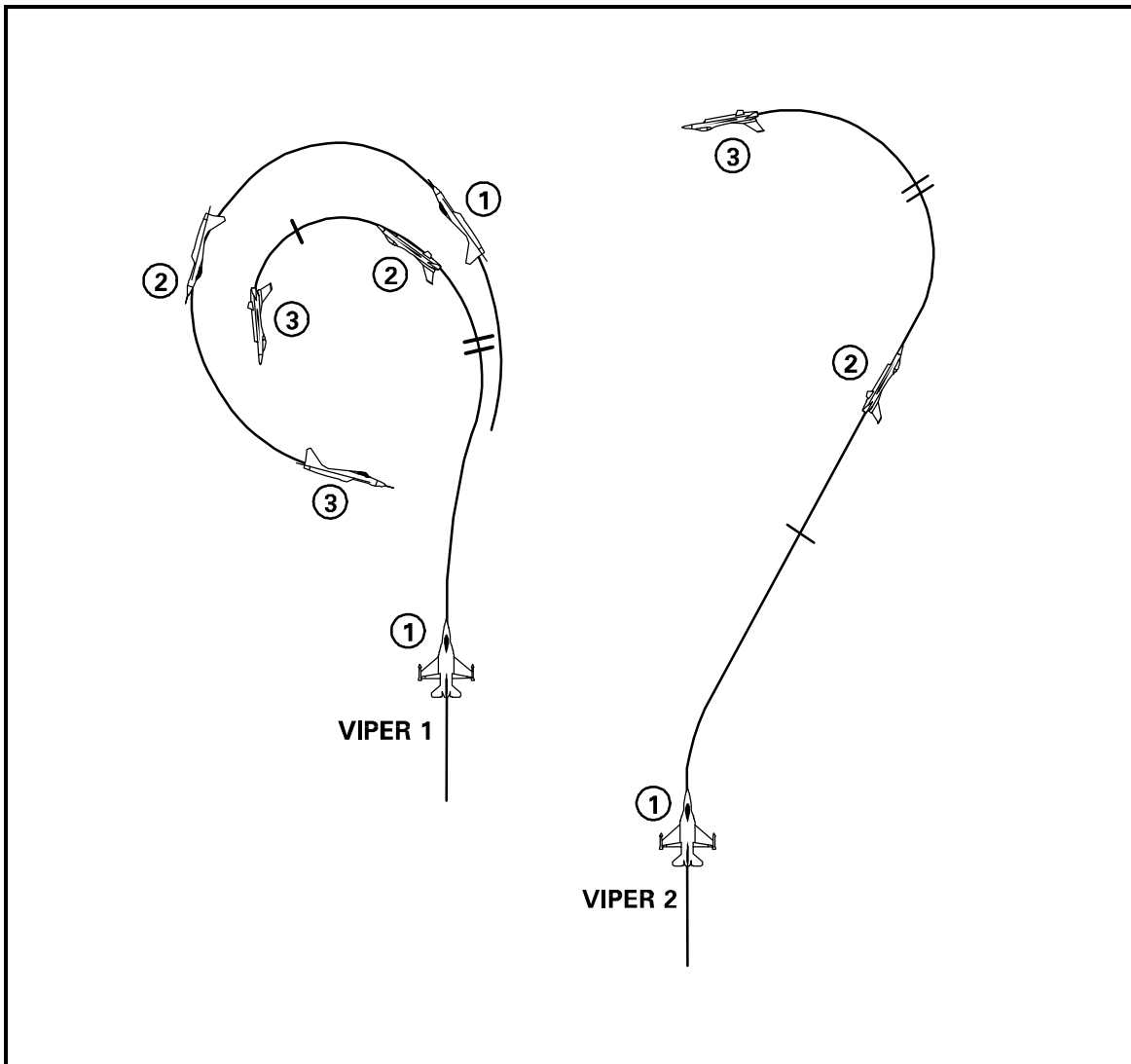
The supporting fighter must avoid three areas in order to fulfill his responsibilities: staying directly above or below, and within 2 NM of the fight.

Flying directly above or below the fight forces the supporting fighter to focus his attention on the fight instead of clearing the area for other bandits. If an entry is attempted, the supporting fighter must fit his turn into an already tight and, most likely, slow turning fight. Although possible, this maneuver is very difficult and often results in an overshoot because of the inability to slow down in a very nose low attitude or extend away from the fight after being extremely nose high.

Trying to stay inside 12,000 feet of the fight may allow the bandit opportunities to employ ordnance against the supporting fighter. This range may also not provide the supporting fighter with the needed turning room to employ ordnance. This causes (at best) rushed shot opportunities and (at worst) missed shot opportunities due to minimum range.

#### 4.10.9. Break Away Turn Away

If the bandit breaks away from the supporting fighter (Figure 4.47), the quickest way to achieve fight separation and a supporting position is to simple check 30 degrees away and extend with afterburner. Again attempt to maintain 450 knots or greater during the extension and build needed separation.



**Figure 4.47 Break Away**

#### 4.10.10. Break Into

If the bandit breaks into the element (Figure 4.48 & Figure 4.49), the supporting fighter has three basic options to option the desired fight separation; Straight Ahead Extension, Lag the fight, and Bracket.

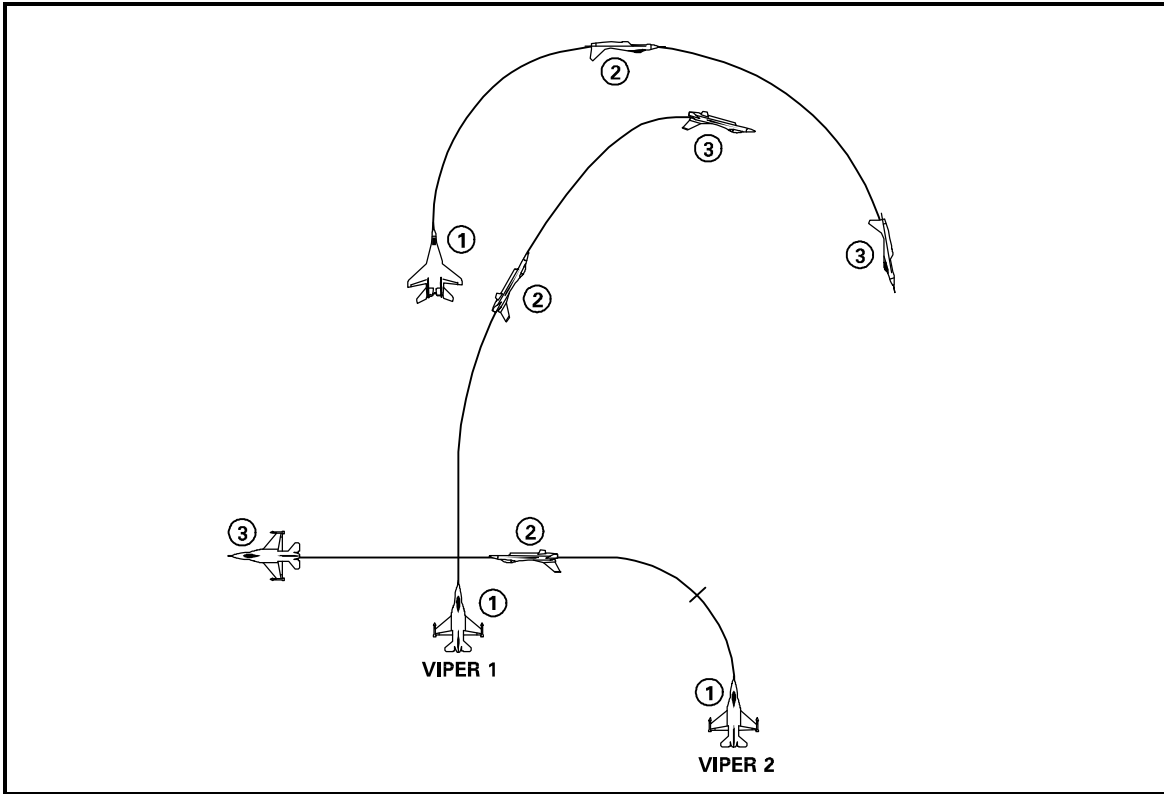


Figure 4.48 Break Into (Turn Into)

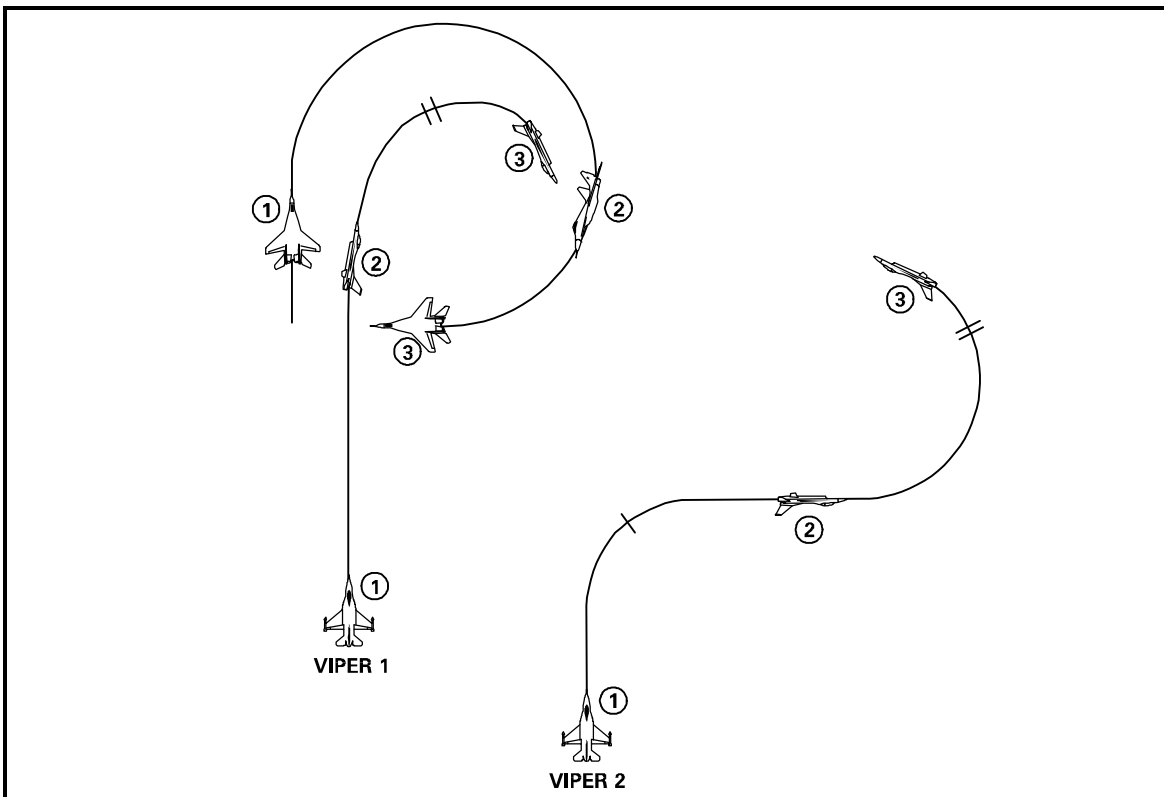
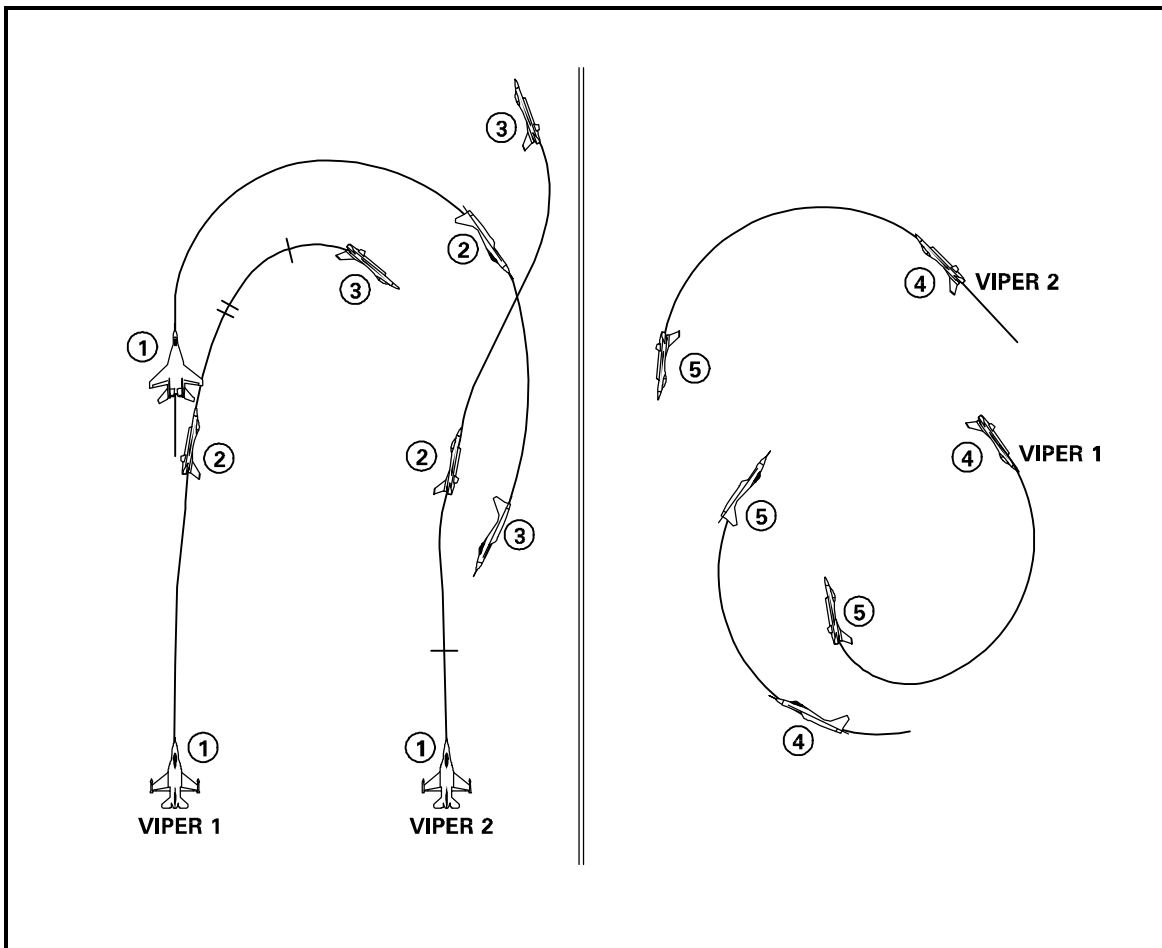


Figure 4.49 Break Into (Turn Away)



#### 4.10.10.1. Straight Ahead Extension

Fly BFM to meet the bandit with high-aspect (Figure 4.50) and split plane to extend through the fight. Once to the outside of the fight the supporting fighter should turn in the direction that is easiest to maintain tally/visual with the fight. Whether your turn places you Co-Flow, same turn direction as the fight, or Counter-Flow, opposite turn direction as the fight, it doesn't matter. The point is your position away from the fight will offer you an entry if the engaged fighter needs your help. Advantage of this is it allows the supporting fighter to unload and extend gaining knots while the bandit is bleeding down energy due to the defensive turn. Also, if the bandit blows up, the element is in an excellent position to egress the fight with good mutual support.



**Figure 4.50 Straight Ahead Extension**

#### 4.10.10.2. Lag The Fight

This option has the supporting fighter point at the lag entry window (as you did in offensive BFM) and flying behind the engaged fighter. This will place the engaged fighter and the bandit on the same side of your canopy and place you in lag with the fight. A high tactical airspeed is required to fly the larger circle about the fight. Ensure to select afterburner at the beginning of the maneuver. Again attempt to split plane in the opposite direction as the fight. This position will allow the supporting fighter to visually check the six of the engaged fighter and radar sanitize the supporting fighter's soon to be six as he turns to keep the fight on the beam. A Co-flow/Fan geometry is setup from this maneuver.

#### 4.10.10.3. Bracket

Bracket is similar to the break away turn away initial move however, a vertical split is definitely required. Simply check away from the fight to place the bandit between the engaged fighter and you.

Once the bandit's nose rotates through you are outside the fight and can maneuver accordingly based on fight status. Advantage of this is if the engaged fighter is denied an offensive position due to effective bandit reactions the supporting fighter is in a good position to engage quickly for a shot of opportunity or an exchange of roles. The disadvantage to this maneuver is that without a vertical split the supporting fighter can find himself in the bandit's WEZ and possibly have to defensively react to survive.

#### 4.10.11. **Fight Entries**

The supporting fighter may need to engage the bandit in several situations. These can be classified into two cases: (1) When the engaged fighter is defensive, and (2) When the engaged fighter is in a high-aspect hence neutral fight that may take a long time to resolve. There are two types of entries, entries from the vertical (above or below), or from outside the bandit's TC in the form of Co-Flow (turning in the same direction as the fight) or Counter-Flow (turning in the opposite direction of the fight). Both entries require vertical turning room to be tactically sound. During an engagement where the engaged fighter is offensive the supporting fighter should not be primarily concerned with shots of opportunity unless the engaged fighter either requests it or survival requires it. A survival issue occurs when the engaged fighter has lost the offensive, hence neutral, or as in a high-aspect pass, or a greater number of threats are inbound that the supporting fighter can't split to engage offensive (i.e. the motherload is 10 miles away and heading your way). The reasonable amount of time the engaged fighter now has to maneuver to achieve a kill has been constrained and the flight needs to communicate this to each other. If the engaged fighter cannot immediately place the bandit in a WEZ and shoot, then the engaged fighter should ask for help and clear the supporting fighter to shoot.

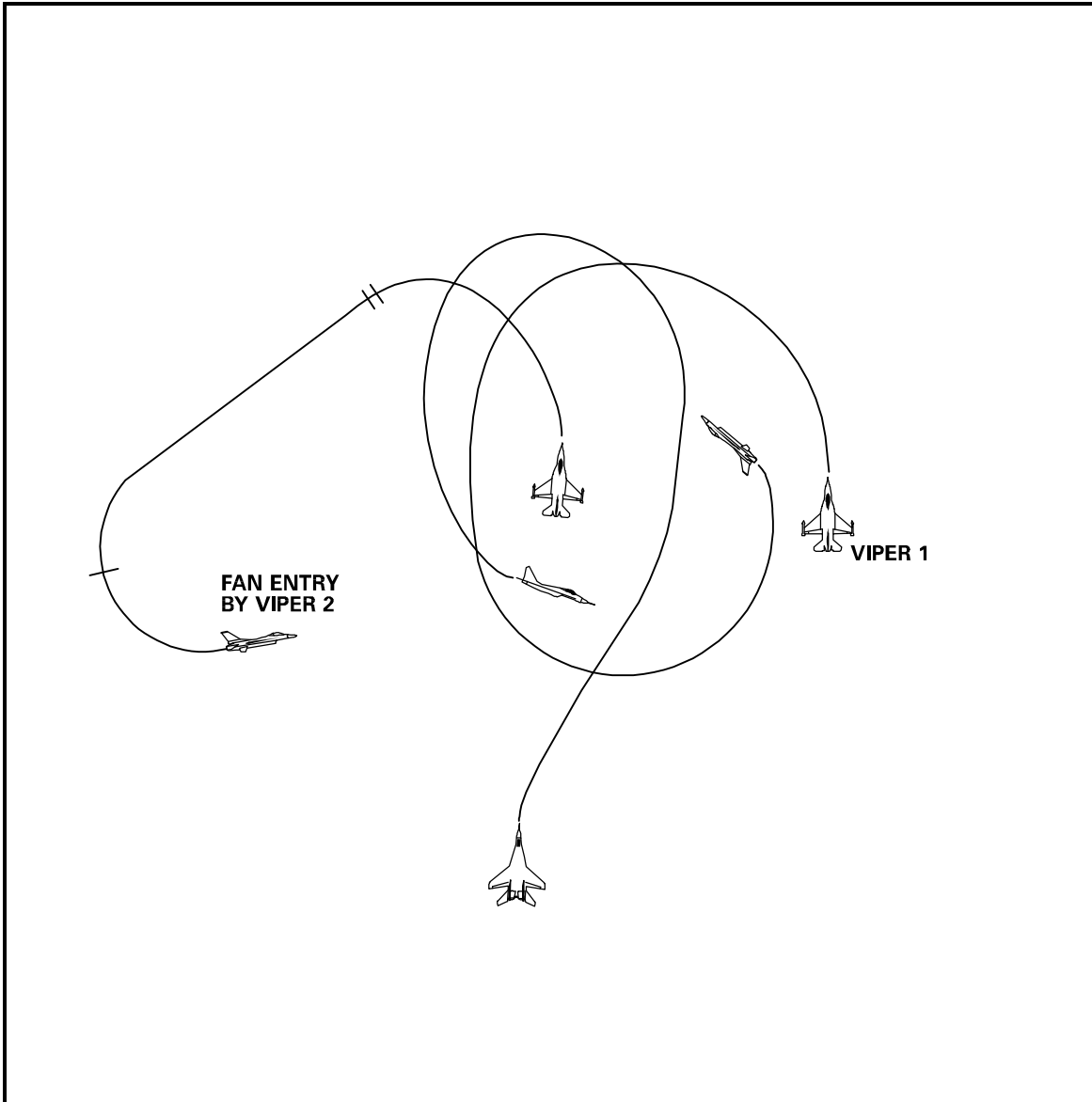
The supporting fighter has set up the support structure and is in a position of advantage, usually high to the inside of the fight. This out of plane position, not normally seen in the BFM phase, offers an entry from above. The entry from below is difficult since most turning engagements go downhill very quickly taking away any turning room you've gained. If the bandit elects to take it up, an entry from below may be available. Vertical entries are fleeting opportunities and must be accurately timed in order for an offensive entry to achieve a WEZ on the Bandit.

##### 4.10.11.1. **Outside Entry**

The other type of entry is from the outside of the Bandit's TC. The supporting fighter gets to this position either because he is outside the Bandit's TC at the initial merge or because he passed through the TC once the fight started. There are two types of outside entries Co-Flow and the Counter-Flow.

##### 4.10.11.2. **Co-Flow Entry**

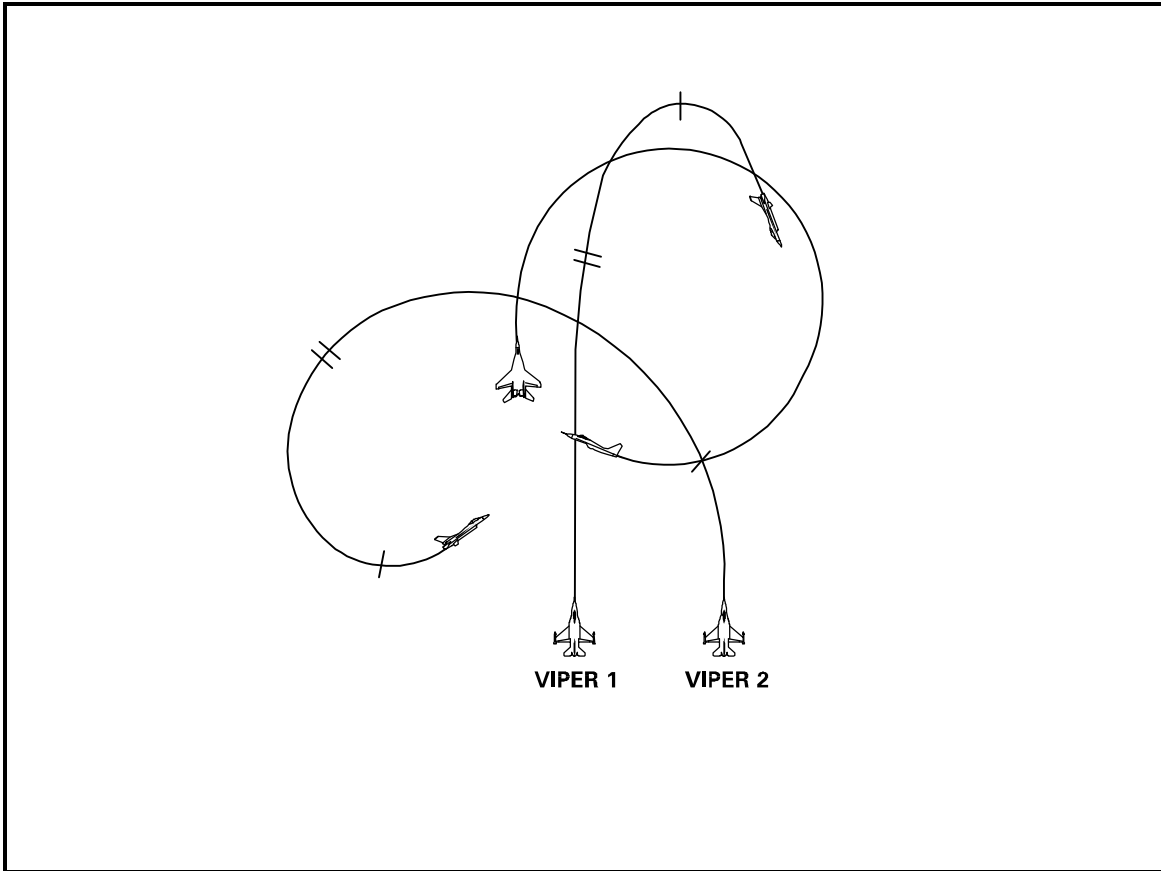
As the name implies both the supporting fighter and the Bandit are turning in the same direction (Figure 4.51). You can get a Co-Flow entry if you are outside the Bandit's TC and as the Bandit's extended 3-9 line passes through your aircraft. As you make the entry it resembles the Heat portion of the Heat-To-Guns exercise. For this entry to work the supporting fighter has to be split plane with the Bandit. If the supporting fighter is in plane with the Bandit, then the potential of getting shot as the Bandit's nose passes through you is very likely. That will probably result in the supporting fighter reacting defensively to the Bandit's threatening nose and does nothing to support killing the Bandit. If in the proper supporting position 2-3 NM offset and with 4000 feet of split plane, the supporting fighter is turning in the same direction as the fight, flying straight lines and hooks. As the bandit's turn brings his 3 - 9 line to your jet, start a turn back into the fight to place it at left 10 or right 2 O'Clock, whichever way is easier to maintain sight. Remember you're supporting and at this moment all you should be doing is denying the Bandit a WEZ by rotating you're heat source away from the Bandit. As the Bandit's nose rotates through you it should, based on range and aspect, it may offer a shot of opportunity, or a position from which a Co-Flow entry into the fight can be made if the engaged fighter needs your help. If the engaged fighter does not need help, continue to sanitize with the radar and visually sanitize your 6 o'clock and the engaged fighter's. If no entry is available or required, check away from the fight by placing it at your 5 or 7 o'clock. The bottom line: don't put the fight on the nose unless you are taking a shot.



**Figure 4.51 Co-Flow Entry**

#### 4.10.11.3. Counter-Flow Entry

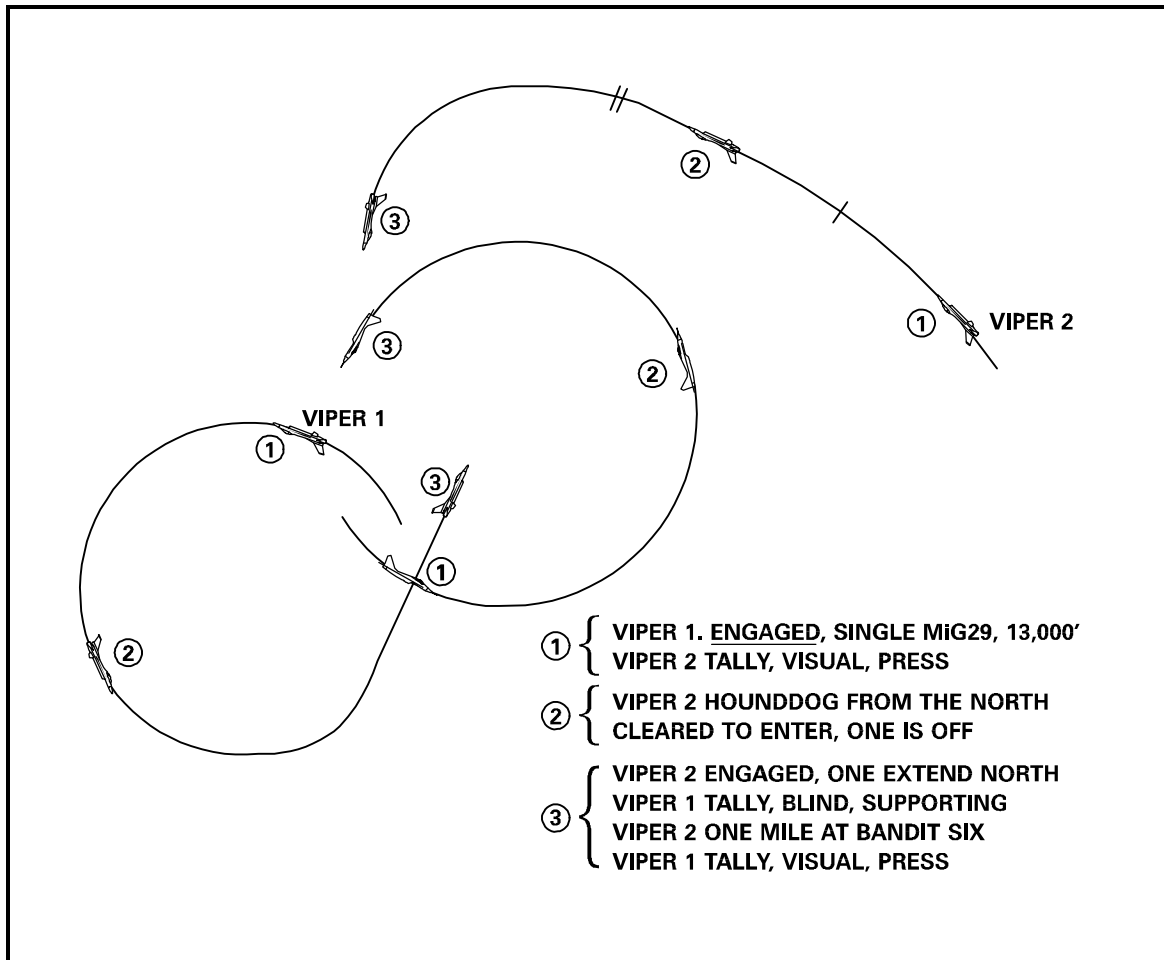
As the name implies the supporting fighter and the Bandit's turn are opposite of each other (Figure 4.52). This entry is very similar to the Co-Flow entry. The major difference between the two is the frequency at which an entry opportunity occurs. Since the supporting fighter is flying in the opposite direction the fight is turning, the bandit's 3 - 9 line will pass through him more often than in a Co-Flow entry. The supporting fighter must strive for lateral and vertical offset quickly. The cues for when to turn in are similar to the Co-Flow except you can turn slightly earlier (lead turn). The geometry is similar to the way gears mesh together. Play the turn to get a belly entry to the control zone.



**Figure 4.52 Counter-Flow Entry**

#### 4.10.12. Role Exchange

Role changes must be positive, clearly communicated, and properly executed by **BOTH** fighters or grave consequences will arise. The CAF continues to run aircraft into one another because two fighters are trying to offensively engage the same bandit simultaneously. The key to success is that both fighters are maneuvering in relationship to the bandit. The engaged fighter is maneuvering to employ ordnance from the "Classic" engaged BFM position and the other is supporting him, not actively employing ordnance until called upon by the engaged fighter. Prolonged turning engagements will only decrease the flight members' situational awareness and could jeopardize survival. The engaged fighter communicating the need for assistance, during offensive maneuvering, is the key for the supporting fighter to actively work for an entry or take a shot of opportunity. The engaged fighter's proximity to the bandit, and weapon FOV, will dictate when the supporting fighter needs to maneuver for an entry or for a shot of opportunity. The supporting fighter, when not offered a shot of opportunity, should be able to maneuver to the control position at the role exchange. If the engaged fighter asks for assistance, ("**Viper One, Neutral**"). The supporting fighter tells the engaged fighter where the entry will come from (i.e. "**Viper Two, entry high, from the north**"). The "*Standard*" engaged fighter reaction should be to acknowledge the supporting fighter's radio call immediately, (because the supporting fighter's entry is fleeting and may not exist in 5 - 10 seconds), with either "Cleared In" or "Negative". The engaged fighter should respond with "negative" if he is again able to maneuver to employ ordnance on the bandit. If the engaged fighter clears the supporting fighter to enter, the "standard" reaction should be for him to aggressively maneuver low to the outside of the fight and assume the supporting role. During the exchange the **supporting fighter** continues to be responsible for flight path deconfliction between himself and the engaged fighter until the roles have been positively exchanged **and** the engaged fighter is visual (Figure 4.53).



**Figure 4.53 Role Exchange**

In this case Viper One called off with “Blind”, therefore as Viper Two assumes the engaged role he has to provide Viper One with the visual. The role change is complete only when the previously engaged fighter transmits either, “Press,” or calls “Tally/ Visual, press”, whichever was briefed as “standard.” The previously engaged fighter can’t simply disregard the bandit during this phase, he must still maneuver in relation to the bandit until the bandit either blows up, or is no longer a factor (i.e. the bandit sees the supporting fighter attacking that attack, or disregards the disengaging fighter and attempts to extend from the fight). The flight members must thoroughly understand these roles and, most importantly, how to change roles, especially in a degraded communication environment or if the visual can not be maintained. The following is another example:

- ① “Viper 1, Engaged, bandit, right 2, 2 miles.”  
“Viper 2, Press.”
- ② “Viper 1, Neutral.”  
“Viper 2, Entry high from the north.”
- ③ “Viper 2 Cleared-in, 1's blind.”  
“Viper 2, Engaged. Your visual 10 o'clock, high, 1 mile.” *NOTE:* In this situation, even though Viper 2 is now the engaged fighter, he is still responsible for element deconfliction until Viper 1 is visual. If the rapidly changing situation prevents this, call blind.
- ④ “Viper 1, Press.” (Viper 1 now assumes responsibility for element deconfliction)

#### 4.10.13. Shots Of Opportunity

A shot of opportunity for the supporting fighter exists whenever the bandit is in a WEZ, the engaged fighter is not in the field of view (FOV) of the weapon during its entire time of flight, the bandit's debris will not be a factor to the engaged fighter and the supporting fighter will **NOT** enter the engaged fighter control zone ( that airspace between the engaged fighter's nose to the bandit). If adequate distance is not provided for, the bandit's debris could endanger the engaged fighter. As a ROT for a missile shot of opportunity, the bandit's aspect to the supporting fighter should be approaching the beam. The engaged fighter should not be within the supporting fighter's HUD FOV, and the engaged fighter should be approximately a turn radius (4-6,000 feet) from the bandit, and the supporting fighter is about 9-12,000 feet away from the bandit with altitude deconfliction. This distance will change in regards to airspeeds and closure between the bandit, the engaged fighter, and the supporting fighter. To employ the gun the supporting fighter is going to have to perform a role exchange to be allowed the engaged fighter's airspace. Under most circumstances the gun opportunity will be fleeting and should only be attempted if it's the only shot available due to being winchester missiles. **During a shot of opportunity the supporting fighter is always responsible for deconflicting with the engaged fighter.** Shots of opportunity support killing the bandit quickly, thus minimizing a turning engagement and allows for higher SA (exactly what you want to do in a combat situation). It is important that flight leads brief in detail, the contract for shots of opportunity.

#### 4.10.14. Egress

When the bandit has been destroyed, the fighter who has the highest situational awareness should initiate the egress. Normally after a turning engagement this will be the supporting fighter's responsibility. By listening to GCI (real world) and maintaining overall situation awareness choose an avenue to egress. Getting the flight moving in the same direction away from the expect threat is the priority (In the MOA/TRA pick a heading, any heading just get the flight moving to the egress). Remember to use directive then descriptive comm ("Viper 1 reference 180," . . .pause. . "Viper 1 visual right 3 O'Clock slightly high" ). Have the afterburner in and get low to isolate the threats above you. It is not imperative that the element be in perfect 6-9,000 LAB formation, but at least visual and heading in the same direction. The fastest fighter will be the one to adjust the formation to regain visual mutual support. Don't have the slow fighter doing excessive maneuvering close to the fireball. Wait until you are 3 - 5 miles away from the fireball and then maneuver the formation to achieve line-abreast. If the slow fighter is out front, the fighter with the higher airspeed will be able close the range and simple fly into position. Get the radar in ACM Slewable or Range While Search (RWS) mode and visually check 6 o'clock. Once you are assured there are no threats within 10 miles, then resume pre-briefed search responsibilities. GCI should be queried for a new picture to start building your situational awareness outside of 20 miles. Now continue with your mission objectives.

#### 4.11. 2 V 1 Defensive Visual Maneuvering

There are four priorities which the element must satisfy in order to survive a defensive situation. They are; detection, negating the threat, maintaining flight integrity/ mutual support through role execution, and lethal weapons employment against the bandit.

When the flight finds itself under attack, the obvious concern is survival (negating the bandit's initial attack). Because fractions of a second are very important, the flight must have some preplanned initial moves; actions that they are very familiar with and have thoroughly practiced. As you would expect, these moves will be based on defensive turns.

Once the initial attack has been negated, the immediate concern of the flight should be to go offensive or separate. Reestablish visual and positional support and maintain tally on the bandit to be sure he is out of range. If the separation is not going to achieve sufficient range, the element will need to continue defensive maneuvering to deny the bandit weapons parameters. The element should use chaff/flares as appropriate.

If it is apparent from the beginning that the flight cannot separate, we have to sandwich the bandit and kill him or force him to separate. Engaged and supporting fighter tactics are now in order. In this case,

however, the bandit determines who is engaged (the one he attacks); the other fighter then maneuvers to sandwich the attacker and bring ordnance to bear.

If both fighters are tally and blind, it is imperative that roles be established. Positive communication and effective maneuvering must be accomplished by both fighters to ensure friendly flight path deconfliction. The flight lead is ultimately responsible for establishing these roles, element survival, and training rule compliance. References off the bandit and/or separate altitudes to ensure deconfliction will help both fighters achieve the visual while increasing SA.

#### 4.11.1. Pre-Engagement Considerations

Your highest chance of being engaged defensively is with loss of situational awareness. This may occur due performing other tasks and not realizing the fact that you're detected. Prevent this by performing a good cross check of the radar, RWR, and visual lookout. Detecting the threat at range (out of a WEZ) is a lot better than noticing a MiG at missile or jinking at gun range reacting defensively for survival. The use of good formation position, visual search, on-board and off-board sensors are required to provide the needed detection of the threat early enough to avoid a defensive situation. As a member of a flight you must make it a priority to maintain the briefed formation, visual and radar search responsibilities within the formations.

Line abreast formation is desired. The formation flown will provide a common reference for communications, targeting, and firepower. The lateral distance between the two fighters depends on several factors ( turn radius of the fighters, WEZ of the fighters, and depth of visual coverage needed for "threat" detection). There are known "blind" zones and human factors that come into play here. The "blind" zone is the area at your extreme deep six that you just can't see due to cockpit field of view. By being in a line abreast formation at least one of the fighters can see into the others "blind" zone and provide the necessary warning when the "threat" is detected. Visual lookout or search must be disciplined: the guns area, IR missiles area, and the All-Aspect Missile area. These areas must be searched using a time share approach. Start with formation position. A look at your flight mate will do three things for the visual search right away. It will assure you are in formation position, correct your "biological" limitation of refocus, and search the area beyond the flight mate for a threat. Next check your flight mate's deep six for a threat in guns range first, then IR missiles. Don't just look for an aircraft. Look for apparent motion, canopy glints, cons, and angel hair. Don't forget to check high 12, low (Belly-checks), and level 3 - 9 as well - a **BIG TASK** ! If during a look inside the cockpit a "spike" is observed don't keep it to yourself communicate that fact to the flight ("Viper Two, Spiked, 10 o'clock). Now start a dedicated search in the avenue of attack. But, don't forget everywhere else like inside the formation, 6, 12 o'clock and outside the formation. That "spike" at 10 o'clock may be 20 or 30 miles away and the real threat that is going to kill you is at your 3 o'clock for 2 miles attempting a silent intercept.

Disciplined radar search will ensure that a specific airspace out to a specific range has been sanitized. Through overlapping of elevation and azimuth coverage early detection of the threat is permitted. However, expect the unexpected. The radar doesn't paint all targets that are out there; in any case, it can't see what's behind rocks and so forth. Early detection allows you the ability to prosecute the attack offensively rather than reacting defensively to the unseen attack, thus increasing your chances for survival. When a "contact" is observed on the radar again communicate this to the flight (Viper 2, contact 5 Southeast Bullseye, 15 Thousand, Head). Together all three of these, formation position, visual and radar search provides for immediate positional awareness of the other flight members.

When the bandit is located (dependent on range and relative position), either split the element laterally and vertically and increase your airspeed, or perform a hard turn or break turn into the bandit. Hard turn is used when the Bandit is not yet in range to employ ordnance. A "Break" turn is used when you locate the threat and someone is in a WEZ. If you are unsure call for a "Break" turn. The directive call for a break turn implies that on board counter measure will also be automatically employed, (i.e. chaff and flares are expended). Never do anything with two that you wouldn't do by yourself, i.e. dragging the bandit at your 6, holding him off, using yourself as bait, - **DEFEND YOURSELF NOW!** Radio calls will normally initiate any move the formation takes. The key to effective communication is to spit out the information IN ORDER using directive then descriptive comments, as discussed earlier. Attempt to assess which fighter the bandit is trying to attack. Avoid flying too close together or level, allowing the

bandit to simultaneously detect both fighters in the formation. Adhere to the briefed formation and perform split plane maneuvering. You must negate the threat by employing sound defensive BFM. If your flight mate can assist you by killing the bandit, that's great but **never depend on assistance from the outside to SURVIVE an attack!**

Maintaining Flight Integrity/Mutual Support and Role Execution: Remember what was briefed by the flight lead as "The Contract" and adhere to it. Fulfill your formation responsibilities (Formation position, Visual and radar search), Engaged and Supporting roles, and use proper radio communications. Survive first, then provide all the support you can. Understand the rendezvous/reform plan your flight will use if stripped (i.e. outside of briefed formation parameters) and use them to regain mutual support as quickly as possible.

The basis of our successful two-ship defense is a system of well thought out initial moves. The moves must effectively negate the initial attack, so they must be aggressive and designed to rotate our vulnerable cone away from the threat. There is no room for error, so the moves should be simple and easy to remember. Lastly, the moves need to become almost second nature; only practice will help here. The main principles to follow in accomplishing initial moves when the bandit is sighted in the aft quadrant approaching missile range are:

- When defensive, avoid putting both aircraft in the same area at the same time. When possible, utilize split plane maneuvering
- The pilot with the tally should always:
  - Do sound BFM by starting a hard/break turn into the bandit.
  - Direct the flight to turn (left or right).
  - Dispense chaff and flares if threatened.

*NOTE:* Attempt should be made to accomplish all of the above items simultaneously.

The pilot without the tally should:

- Perform the turn directed in the direction called.
- Dispense chaff and flares.
- Attempt to acquire the tally.

#### 4.11.2. **Lethal Weapons Employment**

If you are the supporting fighter while your flight mate is defensive, you must maneuver immediately for a shot of opportunity. Attempt to obtain a radar lock by using 10 x 40 ACM or Bore Sight. A radar lock is not required to employ an AIM-9. Ensure the range, angles, and tone are satisfied then shoot the bandit. Don't forget all the BFM skills you've learned. Remember to assess the range and aspect, and maneuver accordingly. Remember the lessons learned in Offensive BFM regarding WEZ management and the recognition that the Bandit is in a WEZ. Now is the time to utilize those skills.

#### 4.11.3. **Execution of Duties**

If the flight is in a WEZ then "break" all flight members in the direction that will allow the best defensive BFM to defeat the attack (i.e. if you see the bandit break the formation so you can maintain sight). Now the task of the defensive fighter, the "engaged fighter," is to fly his best BFM to survive the attack. The supporting fighter needs to maneuver to a WEZ to employ ordnance quickly.

#### 4.11.4. **Classic Sandwich (No Switch)**

A bandit shows up (Figure 4.54) at your flight mate's 6 O'Clock ("Viper break left"). If the bandit continues to attack the initially engaged fighter (in this case your flight mate), the bandit should quickly become sandwiched by the supporting fighter. The "sandwich" is an ideal defensive maneuver and should allow the supporting fighter an opportunity to achieve weapon parameters and kill the bandit. Attempt to obtain a radar lock by using 10 x 40 ACM or Bore Sight. Do not allow the lack of a radar lock hinder you from employing the AIM-9. Ensure the range, angles, and tone are satisfied, then shoot the bandit, especially if the bandit is in close and employing ordnance against your flight mate. **Flight path**



deconfliction with the defensively engaged fighter is the responsibility of the supporting fighter just as in an offensive engagement.

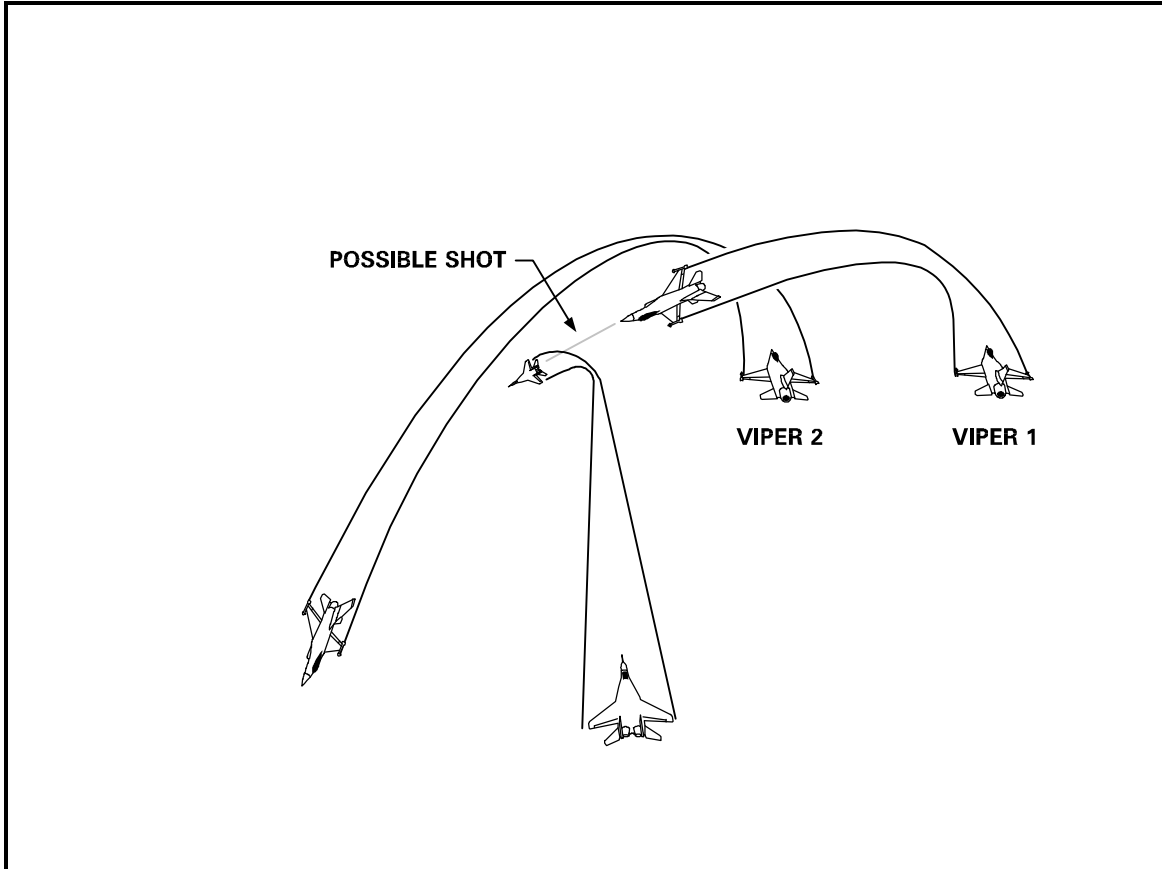


Figure 4.54 Sandwich

#### 4.11.5. Early/Late Switch

If the bandit is aware of the other fighter a "switch" is probable. The switch must be communicated so the engaged and supporting roles can be fulfilled and deconfliction can be assured. An early switch (bandit switch prior to turn circle entry) will enable the initially defensively engaged fighter to change to a constant turn defense or an extension since the bandit's nose will definitely come off and threaten the other fighter (Figure 4.55). The constant turn allows him to back off on the turn rate to keep the same airspeed, keep the bandit in sight, and continue to rotate his vulnerable area away from the bandit while he offsets his turn circle and looks for an entry or shot of opportunity. The extension attempts to regain tactical maneuvering airspeed before attacking the bandit. A late switch (bandit switch inside the turn circle) may allow the supporting fighter to meet the bandit at high-aspect and provide the flight an opportunity to separate from the fight (Figure 4.56). This all depends on the bandit's and defenders BFM. If the supporting fighter meets the bandit close aboard and the bandit's lead turn is denied, a separation opportunity generally is available depending on energy (>300 Kts) and bandit aircraft/ordnance capabilities. The supporting fighter needs to communicate the separation opportunity to the engaged fighter and get the flight going in the best direction (i.e. the way that maximizes the range between the fighters and the bandit.) It is imperative to keep the bandit in sight and to do your best extension. If the bandit chooses to turn and point at the fighters his range and ordnance capabilities must be assessed. If he still appears to be in range and /or you see missiles in the air another defensive reaction is required. If not, keep the tally and keep running until the tactical scenario demands you do something different.

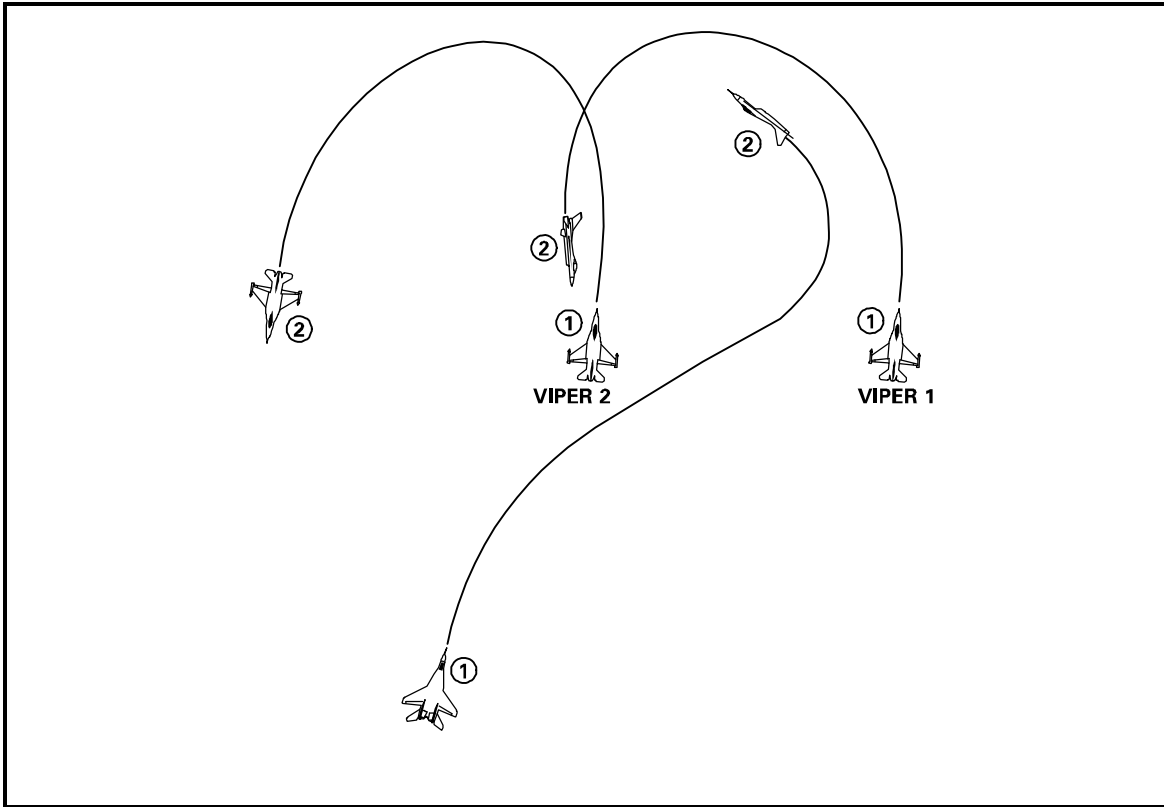


Figure 4.55 Early Switch

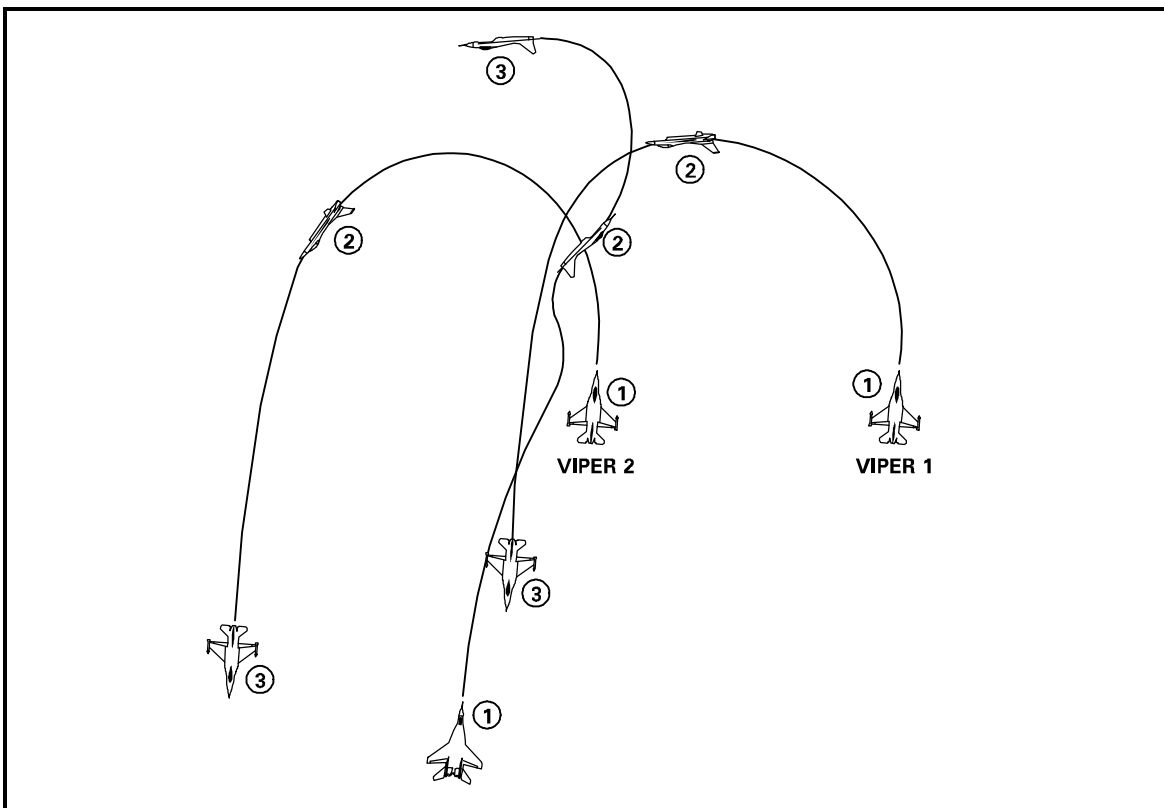
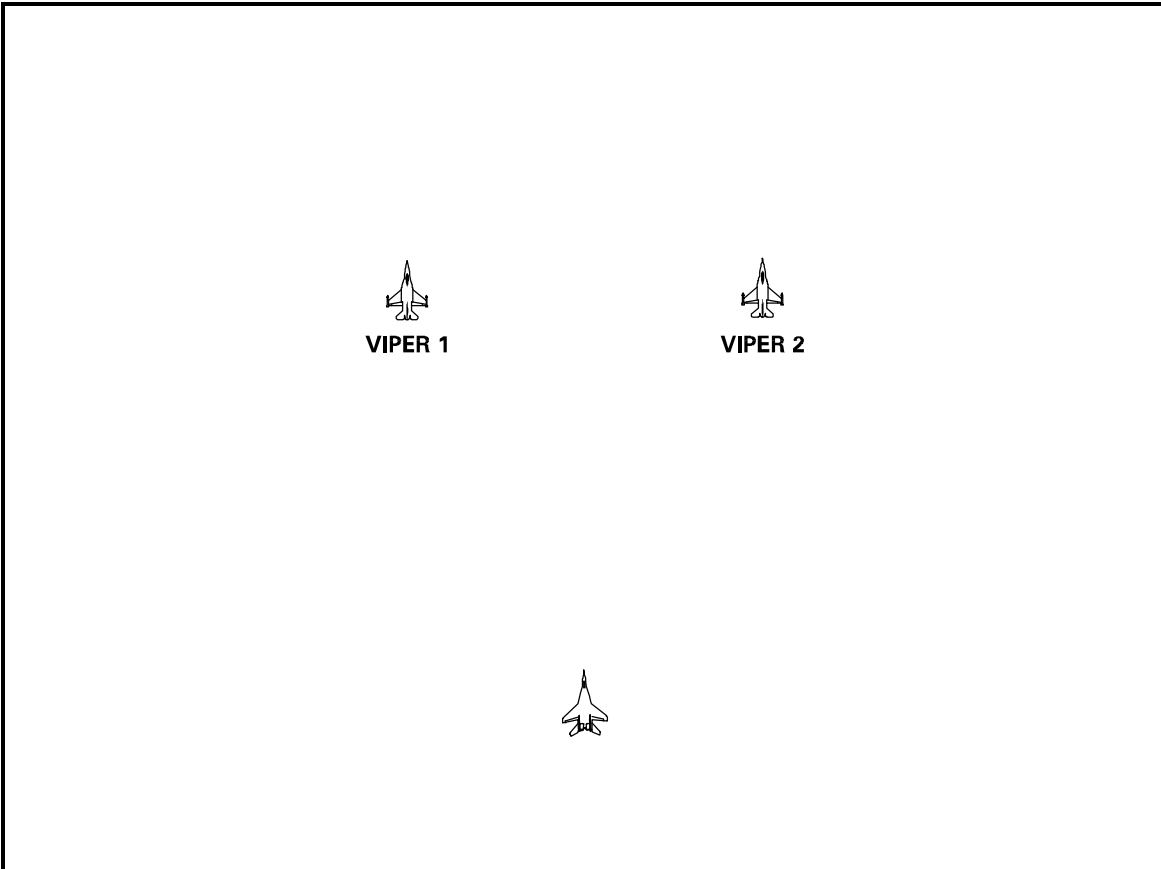


Figure 4.56 Late Switch

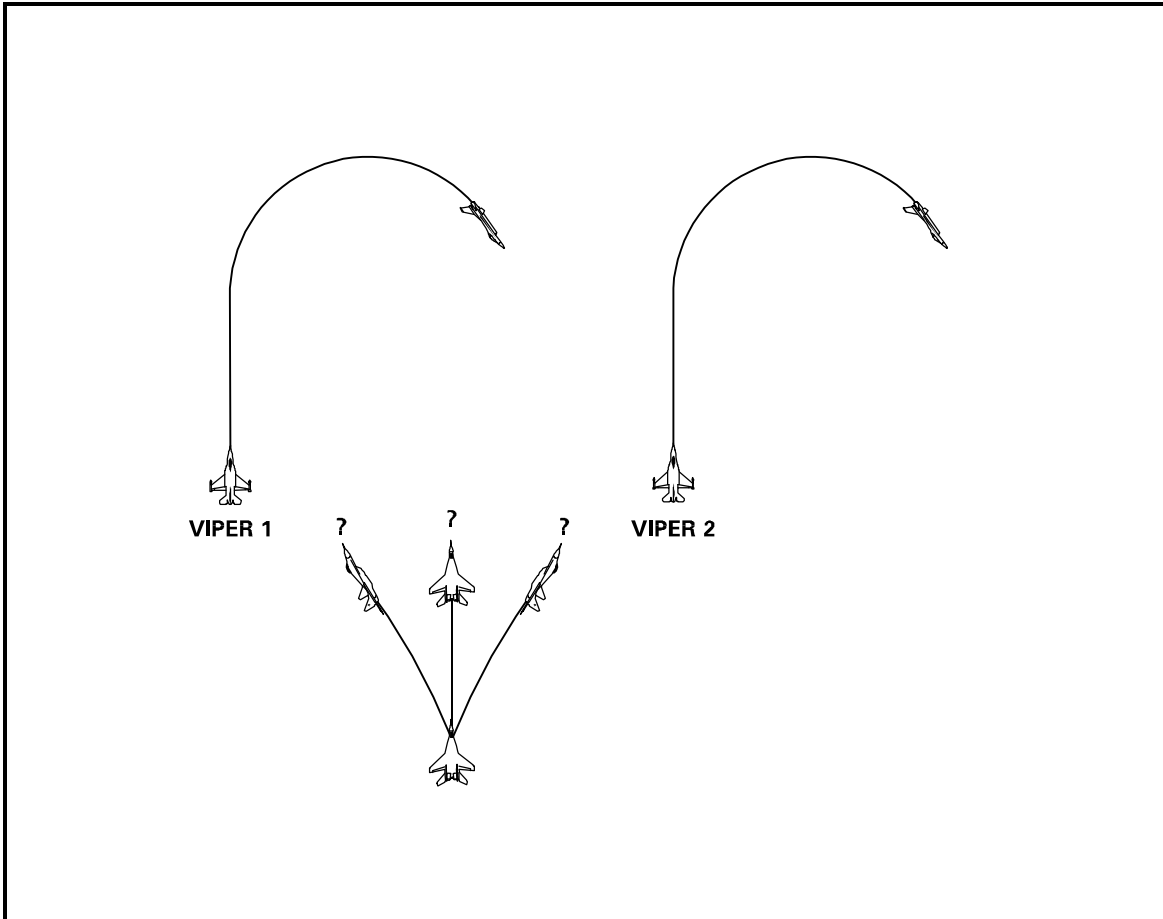
#### 4.11.6. Engaged Fighter Unknown/Uncommitted Bandit

The bandit's position may not clearly identify the F-16 under attack. The bandit can come from any aspect. A quick assessment of the bandit's lethality must be made based on range and nose position. If the bandit has not reached a WEZ, an extension (while monitoring the bandit) may be appropriate. If the bandit is a threat, or continues to close, a prompt flight reaction is required. This discussion addresses the principles valid for all potential bandit attack axes. The initial move should accomplish five things: deny a shot, present the bandit with maximum BFM problems, force the bandit to commit on one or the other fighter, maximize the element's offensive potential after the initial move, and clearly establish engaged and supporting fighter roles. In the example (Figure 4.57), the bandit enjoys a unique positional relationship in which his offensive potential against each fighter is identical. The element has two choices in their initial defensive reaction.



**Figure 4.57 Uncommitted Bandit**

The first option is to break the element in the same direction (Figure 4.58) This is the preferred option if the bandit is detected outside of weapons parameters, or has not yet closed inside either fighter's turn circle. If the bandit is allowed to close to either (or both) fighter's turn circle, the possibility the bandit can take a shot on Viper Two before Viper One can threaten the bandit is increased. The bandit may be in a better position on one fighter and may not allow the other to separate.



**Figure 4.58 Break in Same Direction**

Advantages to this option include:

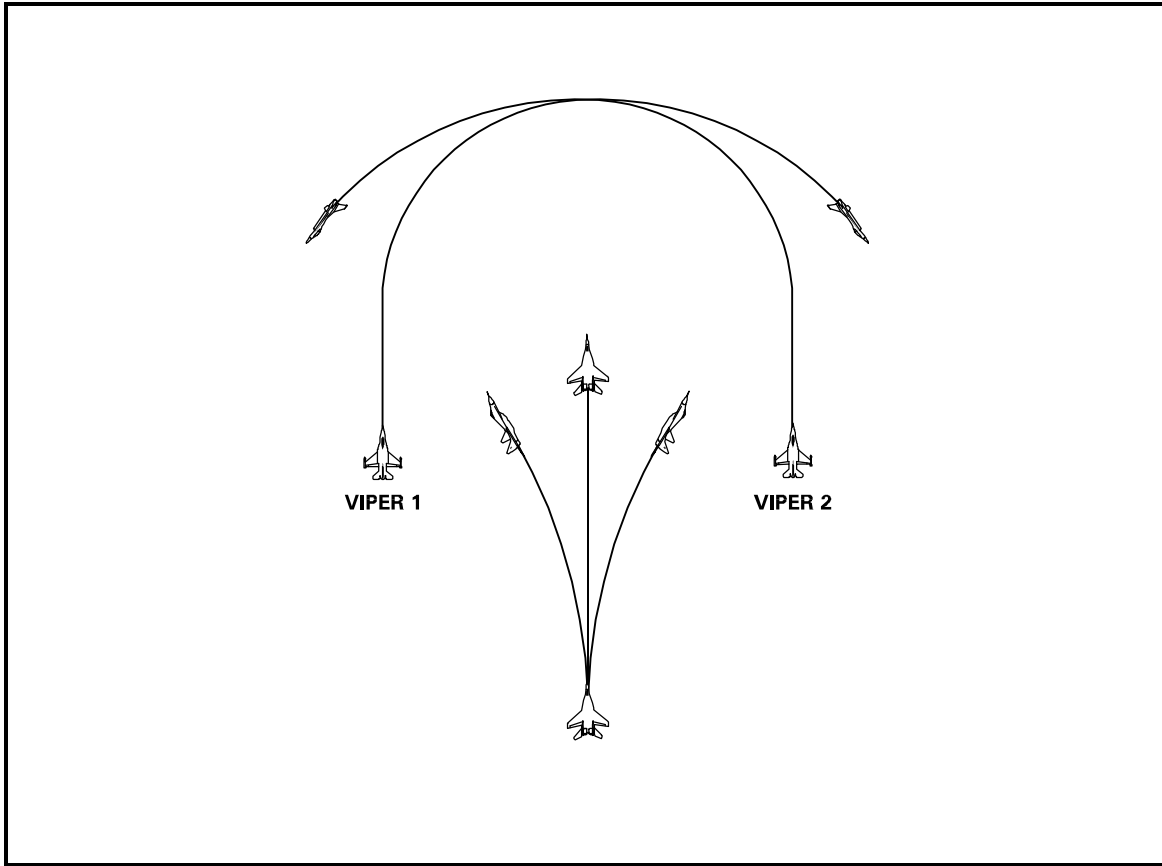
- Viper One is able to maintain tally throughout his turn.
- The bandit must immediately commit against one fighter or the other.
- His offensive potential versus each fighter is no longer identical.
- Each element member can isolate the threat axis on the same side of their respective aircraft.

The element is in a position to establish engaged and supporting fighter roles based on bandit reaction. Viper One can devote full attention to his best 1v1 BFM against the bandit. He does not have to be concerned with a flight path conflict with his wingman. Viper Two starts with the bandit's nose in lag and may be able to rotate his vulnerable cone completely through the bandit before the bandit can bring his nose to bear.

Disadvantages are:

- Viper Two may lose tally as he kicks the bandit across the tail.
- The bandit has a possible shot opportunity as Viper Two starts his initial turn.

The second option is to break the element toward each other in a cross-turn or hard-to-six turn. (Figure 4.59). This option is not the preferred one when the bandit is detected outside of weapons parameters or when the bandit is not inside either fighter's turn circle.



**Figure 4.59 Cross-Turn/Hard-to-Six**

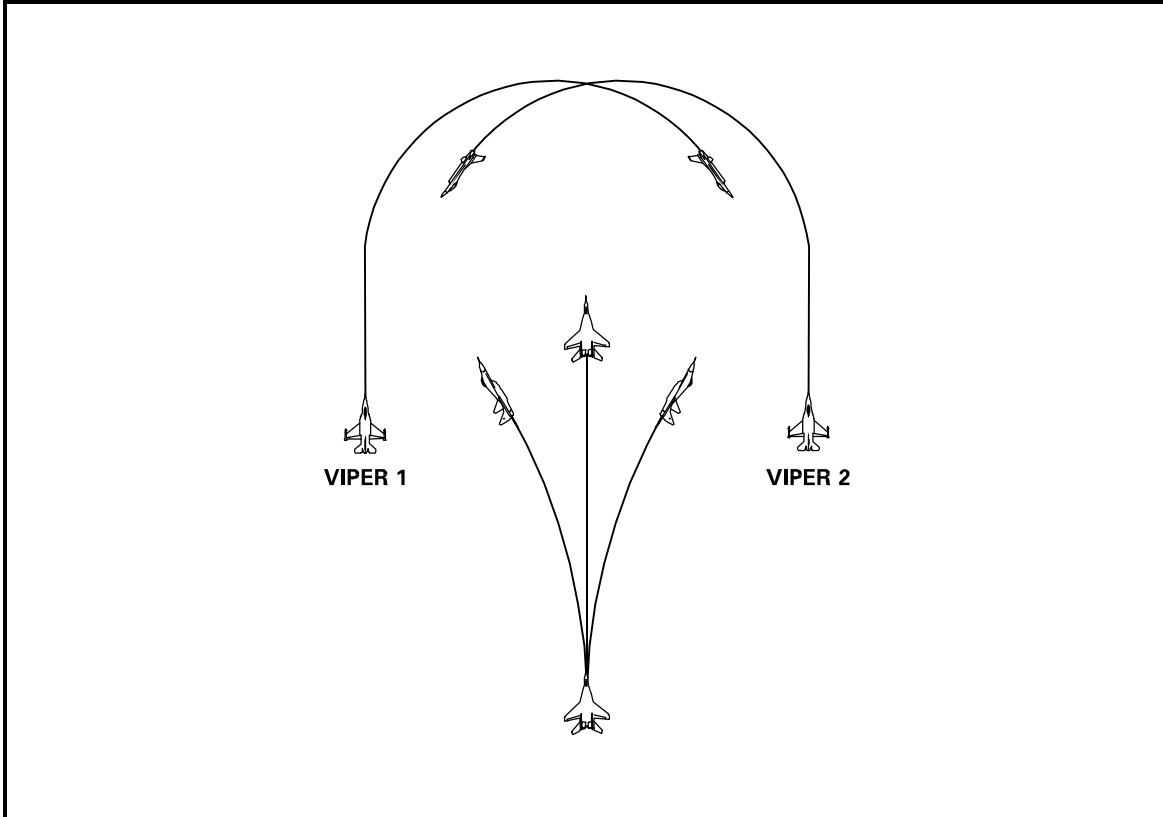
If the bandit is allowed to close before he is detected, the cross turn option becomes less viable (Figure 4.60). At ranges approaching turn circle diameter, the bandit retains the option to employ a gun shot against either fighter, to meet either fighter at high aspect and separate, or switch the attack from one to the other.

Advantages are:

- Each fighter maximizes the BFM problem for the bandit.
- Neither fighter rotates his vulnerable cone through the bandit's position.
- Both fighters have an increased probability of maintaining tally.

Disadvantages are:

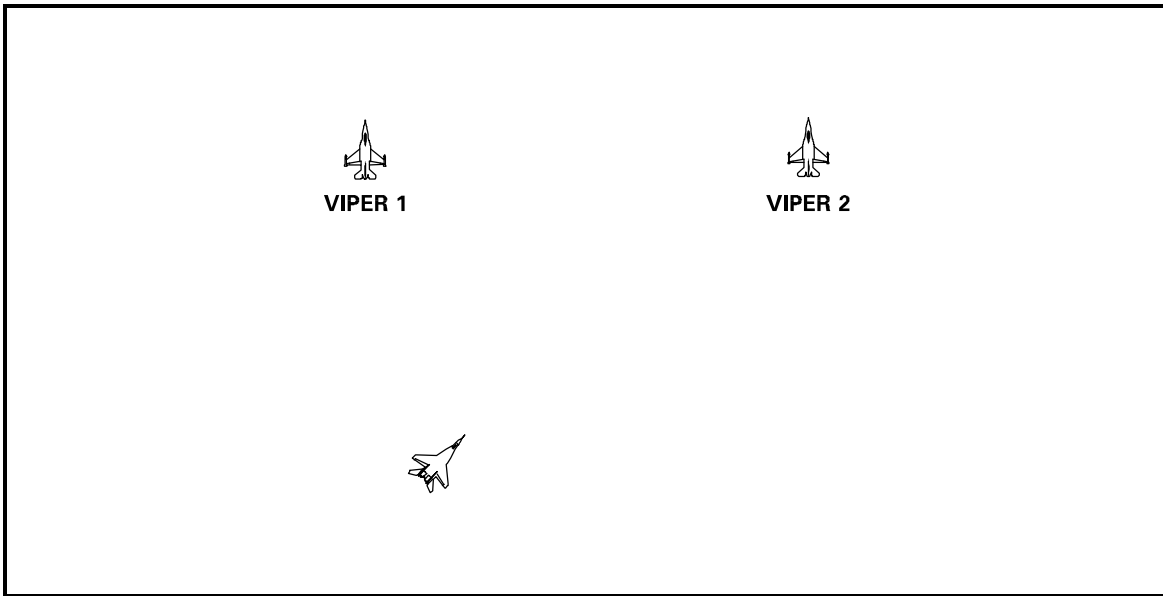
- The bandit is not forced to commit to either fighter.
- The bandit's decision to commit can be delayed until he is closer to (and perhaps inside) both fighters' turn circles.
- The bandit is able to meet one fighter at high aspect and isolate both fighters on one side of his aircraft.
- The assignment of engaged and supporting fighter roles within the element is delayed.
- If both fighters perform hard turns in the bandit's plane of motion, the potential for flight path conflict increases.
- If both fighters maneuver to isolate the threat axis on one side of their aircraft, their flight path vectors are in opposite directions.
- Mutual support is difficult to maintain.



**Figure 4.60 Cross-turn—Bandit Approaching/At Turn Circle**

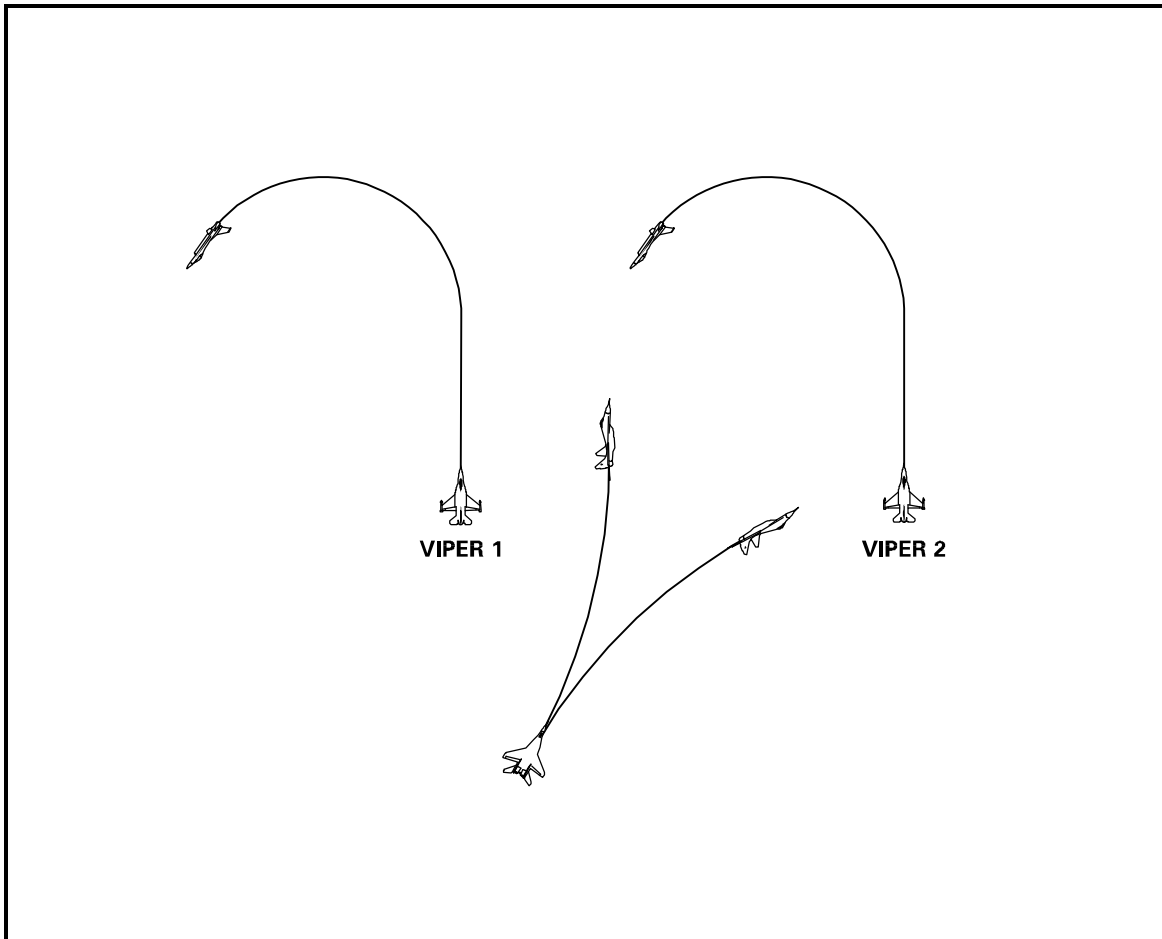
#### 4.11.7. Cross-Court

Bandit asymmetrically positioned between the fighters. In this case, the bandit is in a more threatening position relative to one fighter than the other, but is positioned between the fighters (Figure 4.61). Considerations are similar to the engaged fighter unknown or uncommitted bandit discussion and the options remain similar.



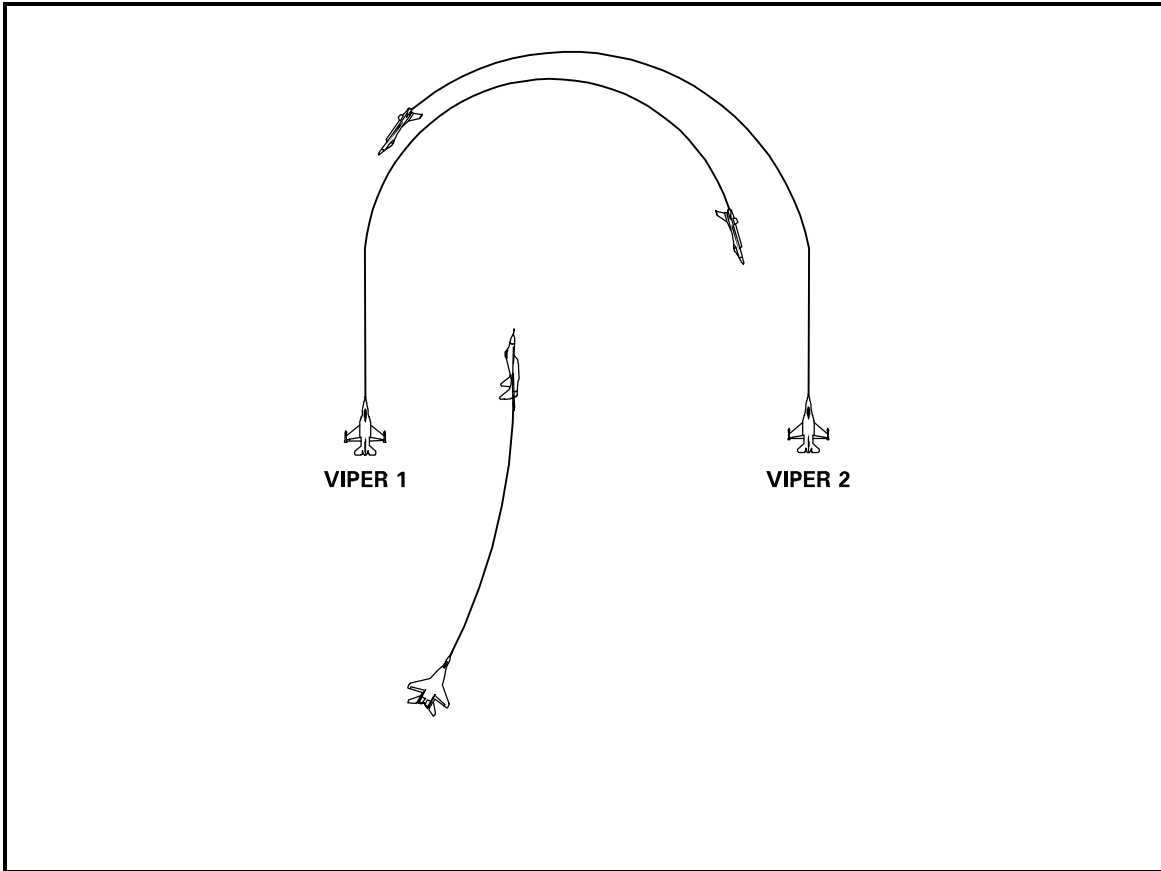
**Figure 4.61 Bandit Asymmetrically Positioned (Cross-Court)**

One option is to break in the same direction (Figure 4.62). The direction of break should be determined by the most threatened fighter. That fighter should be directed to break into the bandit. This option is preferred one if the bandit is detected outside of weapons parameters, or if both fighters have tally. Advantages and disadvantages are the same as previously discussed.



**Figure 4.62 Break in Same Direction (Asymmetric Bandit)**

The second option is to break the most threatened fighter into the bandit, and to also turn the other fighter toward the bandit (Figure 4.63). The advantages and disadvantages to this option are similar to those in the engaged fighter unknown/uncommitted bandit discussion. However, the bandit is probably already committed to the most threatened fighter. This makes the determination of engaged and supporting fighter roles easier. In the case where Viper Two is the only fighter with a tally, it **may** be viable for him to turn toward the bandit to maintain tally as Viper One begins his defensive turn. In this case, if Viper Two decides to turn into the bandit, the turn must be at a rate that will keep the bandit outside Viper Two's turn circle, if possible. Floating the turn when the bandit is at close range may allow the bandit to switch the attack and arrive inside two's turn circle. Viper Two should direct Viper One in his no sight defense and direct an extension if the bandit switches or is no longer a threat to Viper One. Additionally, Viper Two **must** default to Viper One during Viper One's defensive turn to preclude a flight path conflict from developing. This option is viable if Viper Two is the only one with a tally, or if the bandit is already established inside Viper Two's turn circle.



**Figure 4.63 Cross-turn/Hard-to-six (Asymmetric Bandit)**

#### 4.11.8. Re-Entry

Re-entry into a fight where a fighter is **defensive** is the highest priority of the supporting fighter. Place the fight at your 10 o'clock or 2 o'clock and strive to have at least a turn radius and a half of room (around 1 NM) between you and the bandit. Split plane maneuvering may allow you to get outside the bandit's FOV. If the bandit doesn't point at you and continues his turn a shot of opportunity should be available. Be ready to employ ordnance as soon as possible. If the fight has gravitated to a scissors you can expect extremely slow airspeeds. The AIM-9 is the weapon of choice. Allow the fight to drift aft to about 7 or 4 o'clock and then turn in to the fight looking for a low-aspect missile shot as the distance between the bandit and the engaged fighter increases and is greater than the HUD FOV. The entry is just like a Co-Flow or Counter-Flow entry. If winchester missiles and the only ordnance available is the gun then maintain at least over-the-top airspeed as you enter the fight and anticipate a high angle gun attack to a high reposition. You don't want to be co-air-speed with the fight and get anchored in the scissors. But being greater than 400 KTAS is also not advantageous to entering a scissors. It doesn't allow enough time for the shot. Refer to the section on role exchanges for additional information and comm procedures.

#### 4.12. High-Aspect ACM

An optimum entry against a high-aspect threat is the bracket. The goal is to sandwich the bandit similar to that discussed in the defensive ACM section. The only difference is that the bandit starts out ahead of the 3/9 line and with high aspect. A 2-ship spread out to 3-4 miles will allow the flight to maintain visual mutual support and determine which fighter will have the best advantage to engage offensively or take a shot of opportunity at the merge. Communications are critical to determine which fighter will be the engaged fighter. A going-in position that should be briefed is that the flight lead will be the primary engaged fighter. Here is a classic situation that allows for a pre-merge role change to allow the most offensive fighter the engaged role.



As the flight lead analyzes the aspect of the bandit and continues to the merge performing a single side offset intercept, the wingman maneuvers away from the flight to obtain turning room. If the aspect between the bandit and the flight lead remains high the flight lead should clear his wingman to engage the bandit. The fighter who meets the bandit high-aspect assumes the supporting role. As he approaches the merge he should still attempt to achieve a front quarter shot and then pass the bandit as close aboard as possible, preferably placing the bandit between himself and the engaged fighter. This should force the bandit to turn belly up to the engaged fighter. The engaged fighter maneuvers offensively to employ ordnance or pressure the bandit to make him predictable. Any fighter the bandit engages post merge should allow a shot of opportunity to the other.

Off axis bandits pose additional problems. We want to avoid letting the bandit meet both of us close aboard and then maneuvering to place both of us ahead of his three-nine line. The solution here is to have one fighter engage and get the bandit turning while the other maneuvers to a supporting position and subsequently into a shot of opportunity or a role swap when clearly able to be offensive.

#### 4.13. Intercepts

An intercept is the series of maneuvers, using a ground controlled intercept (GCI), Airborne Warning and Control System (AWACS), on-board systems, or dead reckoning, which places the aircraft in a position from which a weapon may be employed, visual identification (VID) can be made, or a visual engagement can be initiated. The tactical decision to "commit" to an intercept is based on guidance and criteria established in MCM 3-1. The type of intercept geometry utilized is based on experience, proficiency, avionics, weather/ night, ECM and tactical considerations. This manual will review intercept basics and the baseline intercept. Some tactical considerations will also be discussed, however reference to MCM 3-1 is necessary for a complete understanding of tactical intercepts.

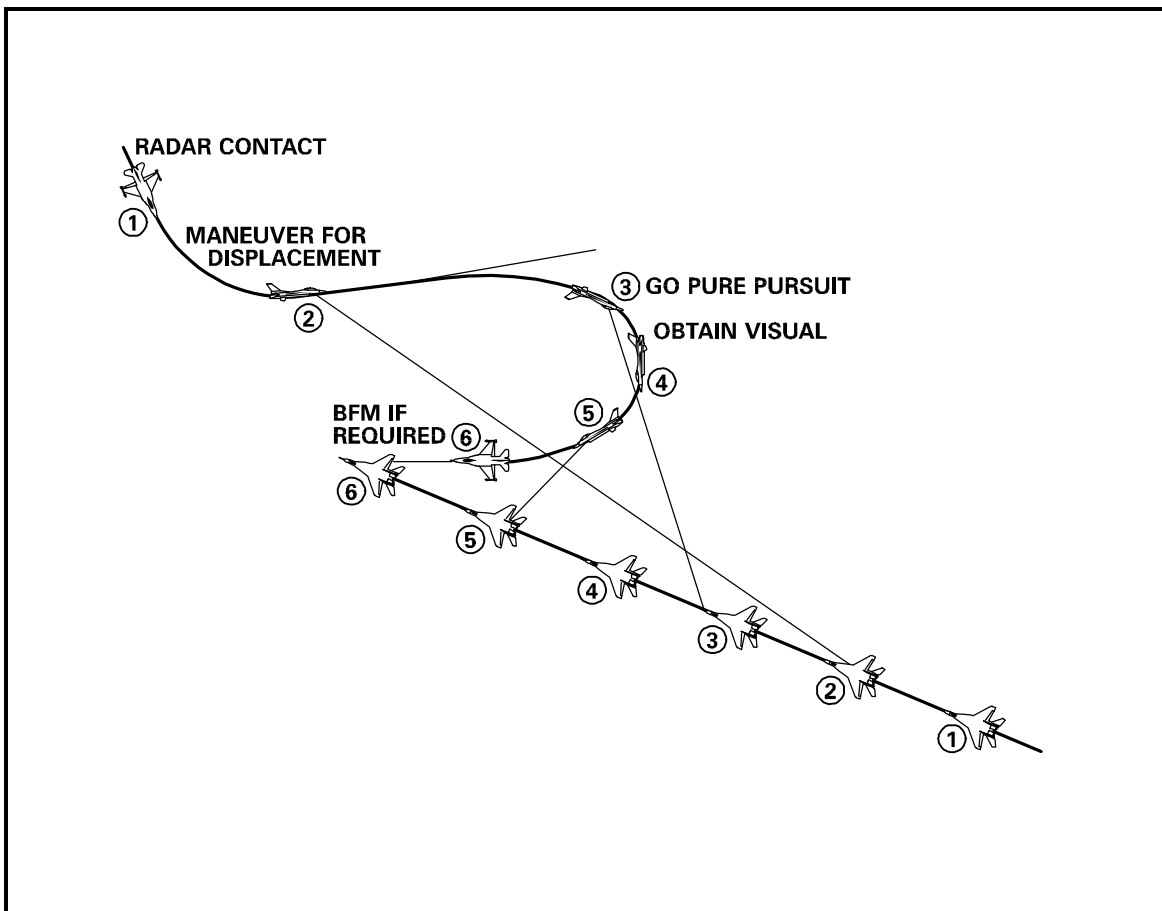


Figure 4.64 Intercept Basics

#### 4.13.1. Intercept Basics

In the F-16, the intercept problem involves using the radar to detect a specific target, then using the intercept geometry to arrive at a position from which the target can be identified (if required) and weapons fired. To achieve this, the fighter pilot must do these things (Figure 4.64):

- Close on the target.
- Establish ID (may be a continuous process).
- If a beam or stern conversion is required, acquire sufficient displacement from the target (room for the conversion turn).
- Go pure pursuit.
- Obtain a tally.
- Establish a VID if required.
- Maneuver to weapons parameters.

A popular technique for accomplishing these steps is the baseline intercept. This is the foundation upon which more complicated tactical game plans are built. Before discussing the baseline intercept, a few of the intercept terms will be reviewed.

#### 4.13.2. Intercept Terminology

Fighter pilots should be familiar with all the terms listed in attachments 1 and 2 of this manual. Listed below is a review of a few of the terms essential to intercept geometry.

*Aspect Angle (AA):* The angle between the longitudinal axis of the target (projected rearward) and the line-of-sight to the fighter, measured from the tail of the target. The fighter's heading is not a consideration.

*Antenna Train Angle (ATA):* This is the angle between the nose of the fighter and the radar line-of-sight to the target. ATA is referenced in degrees left or right of 0° azimuth on the MFD.

*Collision Antenna Train Angle (CATA):* CATA is the azimuth of the radar antenna when tracking a target that is on a collision course with the fighter. This is the fighter's quickest route to an intercept/collision/tally with the target. A target on a collision course drifts straight down the MFD. Its azimuth never changes. An easy way to determine CATA for a cospeed target is to subtract aspect angle from 180°. For example, the CATA for a target with a 150° aspect angle is 30° (180 - 150). Figure 4.65 shows these angular relationships.

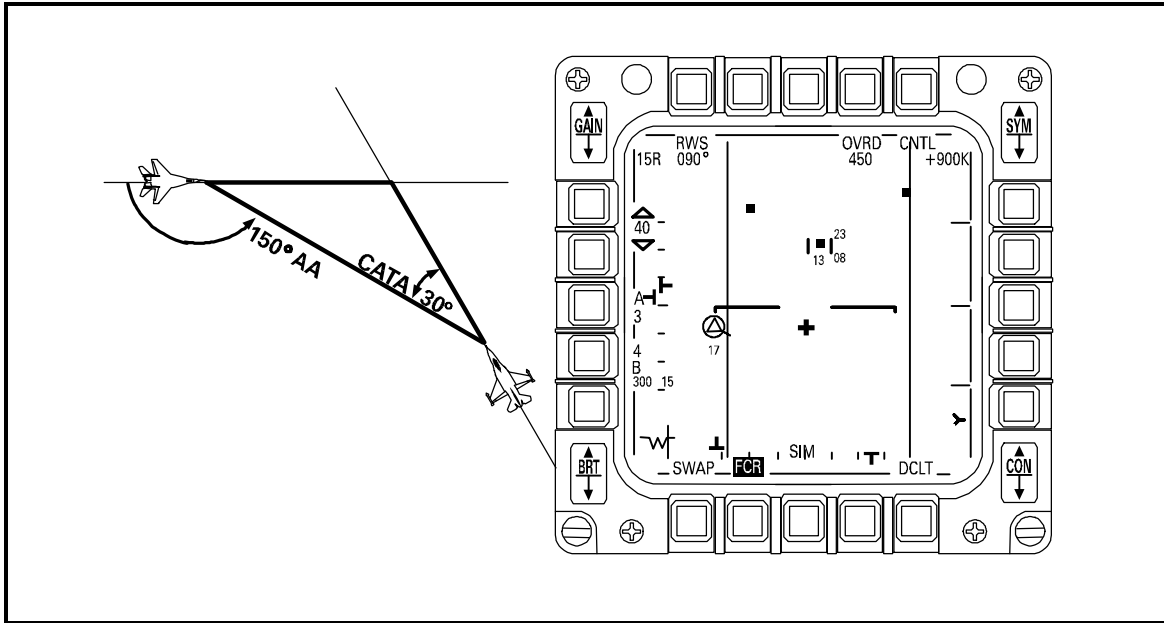


Figure 4.65 CATA

#### 4.13.3. The Baseline Intercept

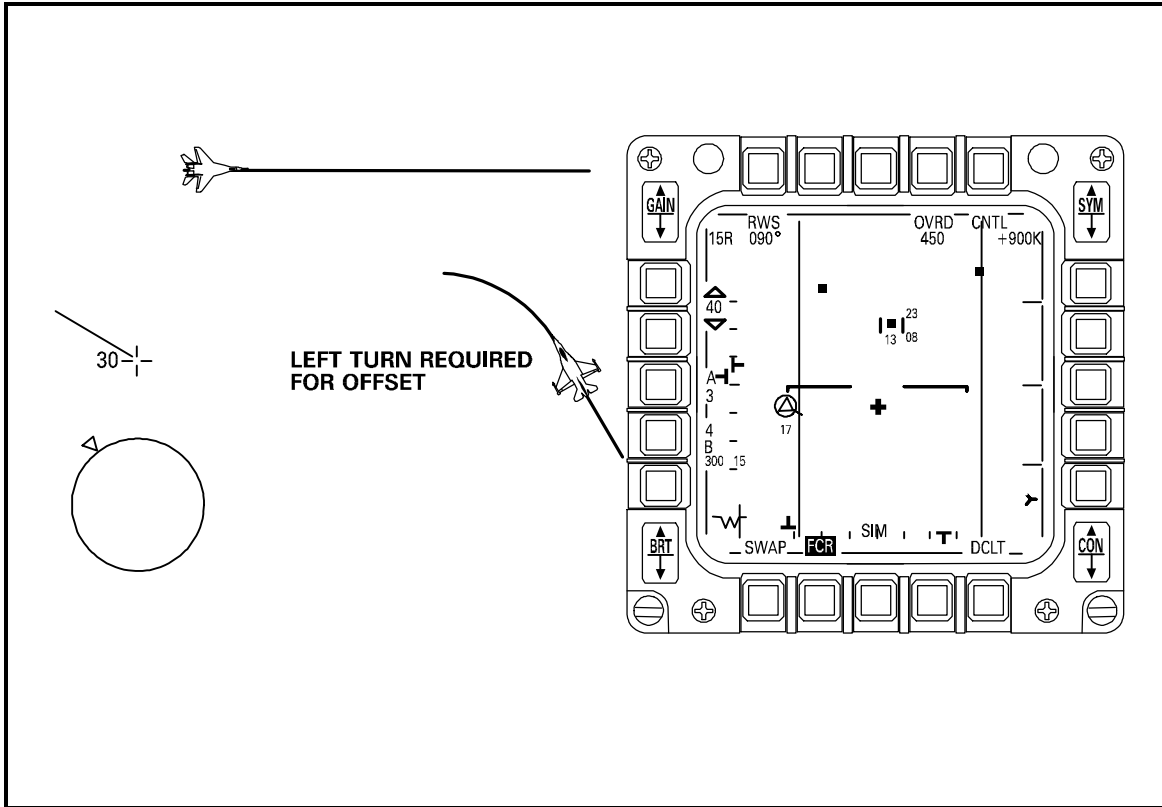
This section will provide a very basic and simple review of the baseline intercept. For this discussion, it is assumed that the intent is to acquire some turning room (offset) to complete a conversion turn to the target's beam or stern. There are six steps in the baseline intercept:

- Get on the CATA until 20 miles.
- Get some offset at 20 miles.
- Get a speed advantage.
- Monitor aspect.
- Go single target track (STT) at 10 miles.
- Go pure pursuit at 120° aspect (6 - 8 NM range for a high aspect setup).

*CATA Until 20 Miles.* The easiest method of getting on the CATA requires the radar to track the target (STT, SAM, or TWS tracked target). Simply turn toward the intercept steering symbol, or steering cross, until it is centered at 0° azimuth. The target is on the CATA when the cross is centered (Figure 4.65).

*Offset at 20 Miles.* Getting horizontal offset, or horizontal turning room, requires analysis of the target's aspect angle. The aspect angle is most accurately read from the MFD, although the aspect symbol in the HUD is also useful. In this discussion, it is assumed that the fighter has kept the target on the CATA until 20 NM, and then takes the following action:

- If aspect angle is more than 120°, turn to displace the target 40° - 50° off the nose (40° - 50° from center of the MFD). Which direction to turn is a common question for beginners!
- If aspect says "right" (e.g., 160R), turn to put target on the **right** side of the MFD.
- Look at the aspect caret in the HUD. If it is right of center, turn right, and if it is left of center, turn left.
- Look at the aspect readout in the MFD. Turn opposite of the letter at the end of the aspect readout (e.g., if the aspect says "15R," turn "L" or left). Figure 4.66 illustrates both HUD and MFD indications.



**Figure 4.66 Cues for Offset Turn**

In the case of a non-maneuvering target which began with high aspect ( $160^\circ - 180^\circ$ ), as range decreases, the target will drift further towards the edge of the MFD and small check turns into the target will be required to maintain it at  $40^\circ - 50^\circ$ . During this phase, avoid gimbaling the target off the scope (and losing contact) by constant reference to the HUD target locator line. Never let the target locator line exceed  $50^\circ$ .

If aspect angle is  $120^\circ$  or less, remain on the CATA and proceed to subsequent steps of the baseline intercept, always remembering the last step (go pure pursuit at  $120^\circ$  aspect angle). At aspects less than  $120^\circ$ , it is possible that the target will be driven off the MFD when turning to CATA. Do not gimbal the target in an attempt to center the CATA symbol. Keep the target at  $50^\circ - 55^\circ$  offset in this case.

Vertical offset, or vertical turning room, can actually be obtained as soon as you know the target altitude. You don't have to wait until 20 NM. Vertical turning room should be at least several thousand feet, weather/terrain permitting.

The following advantages of an altitude split may or may not apply to each tactical situation:

- To get out of his radar coverage vertically.
- To use the ground clutter to help hide from his radar.
- To get the most favorable background to pick him up visually.
- To get the most favorable background to hide your jet visually.
- To get an energy advantage.
- To hide in his blind areas.
- To reduce the horizontal turning room required; makes you less susceptible to a maneuvering target.
- To gain airspeed quickly by going low.
- Or to slow your closure by climbing above the bandit.

The disadvantages of an altitude split are:

- Elevation strobe control is more difficult at high look-up/down angles.
- If your radar breaks lock, it's harder to re-acquire the target at closer ranges.
- It is easier to lose radar contact on a no-lock intercept.

*Get a Speed Advantage:* A good rule of thumb is to have a 150 KCAS advantage if coming from below, and 50 - 100 KCAS advantage if coming from above. These rules of thumb are for medium altitude and may have to be adjusted for high altitude intercepts.

*Monitor Aspect:* Provided the target does not maneuver, aspect angle will decrease continuously after the fighter has taken the correct horizontal offset. An increase in aspect angle at this point means the target is turning into the fighter. A rapid decrease in aspect angle means that the target has turned away. How to handle a maneuvering target will be discussed later.

*Go STT at 10 Miles:* This will enhance the chances of retaining the lock through the conversion turn. One of the easiest methods of obtaining STT is moving the dogfight/missile override switch to a position programmed for ACM. Aircraft block differences and personal switchology techniques will dictate other methods.

*Go Pure Pursuit at 120° Aspect/6 - 8 NM:* The 6 - 8 NM is not a hard and fast rule, but in most head-on setups (initial aspect 160 - 180), the 6 - 8 NM point occurs at approximately the same time as aspect angle reaches 120°. The important thing to remember about this step is to go pure pursuit (get the TD box in the HUD) anytime the aspect reads 120°. No matter what the aspect, go pure pursuit not later than 5 NM. This is where the F-16 excels due to its avionics and small size. Use the HUD target locator line to bring the target into the HUD field of view. During conversion from a high-aspect setup, at 3 - 4 NM range there should be approximately 90° remaining to turn. The fighter may already have a tally and be in parameters for a missile shot. Use BFM as required to maneuver into weapons parameters.

#### 4.13.4. **Night or IMC Intercepts**

Reference night or IMC intercept discussion in Section 8.

#### 4.13.5. **Wingman Responsibilities**

The wingman's primary job during an intercept is to support lead to the merge. This includes: checking six o'clock for the flight, targeting threats to lead's merge, engaging bandits not targeted by lead that are a factor, or calling lead off an engagement to deal with a higher threat. To perform these functions, the wingman must be able to do three things: (1) maintain formation, (2) communicate on the radio, and (3) employ valid weapons to kill.

##### 4.13.5.1. **Maintain Formation**

A typical deployed formation for a tactical intercept is 5000' to 7000' out, 30° to 45° back with an altitude stack (see trail formation). If deployed to the inside of the turn, stacking high may cause loss of visual under the canopy rail during the conversion turn. A low stack solves this problem. If deployed to the outside, strive for the most forward position possible and maintain an energy advantage by stacking high. As lead converts on the bandit, flying in the low/inside position requires caution to not be pushed out in front of lead's 3/9 line. On the other hand, the high/outside position requires anticipation to use altitude to accelerate and avoid being trapped at lead's six o'clock as the merge occurs.

##### 4.13.5.2. **Communicate on the Radio**

Efficient communications mean a rapid, meaningful **exchange** of information occurs to enhance everyone's SA on the problem at hand. When GCI talks to the flight, lead should answer. If all he can say is "Viper One, clean", then at least GCI knows comm is good. When interflight communication occurs, both element members must say what they know or don't know. "Viper One, contact two groups, 10 NM west bull's eye," followed by silence is not communication. Viper Two must respond with "Viper Two, clean/same" or whatever he has. As the intercept progresses, any changes in what the element sees must be communicated **and** acknowledged. The ability to intercept what is on the radar is a prerequisite to communicating what you see. Target formations, maneuvers and tactics are explained in MCM 3-1, Volume 2. Remember, when lead talks or something changes in the radar scope, a radio call is required. Radio calls should be as complete as possible. "Viper Two, contact" tells lead nothing about the contact's

position, altitude, formation, maneuvering, or possible intentions. Often a wingman will only give part of the information available in an attempt to be brief. An incomplete radio call that begs a question will require extra radio calls.

#### 4.13.5.3. Weapons Employment

Valid weapons employment is the only thing that will kill threats to the formation. A precise knowledge of the weapons envelopes, as well as the leader's criteria for engaging, will allow efficient weapon employment. For example, lead may brief the wingman to shoot any confirmed target within 45° of the nose and 5000' of altitude. This rather restrictive criteria allows the wingman to engage threats within those parameters while maintaining formation integrity.

### 4.14. Gun Employment

The F-16 is one of the most lethal fighting machines in the world today. The combinations of missile technology and F-16 avionics make weapons employment in the tactical arena more effective. Missile employment is contained in MCM 3-1. The following discussion will center on gun employment.

Gunshots range from very controlled tracking opportunities to very dynamic snapshot situations. Apparent LOS relative to the shooter and the defender's turn rate capability dictate which type of shot is available; tactical considerations dictate which is the most feasible. Every gun opportunity must be judged and handled with proper concentration given the trade-off between target destruction and your survival. How predictable can you be? How much energy can you expend and what will you do after the shot? Can you afford the time to take the shot?

#### 4.14.1. Tactical Considerations

There are two basic situations where gun use is required: when the gun is the only available weapon, and when a target of opportunity (inside the missile minimum range/angle envelopes, but within gun parameters) presents itself. Gun solutions, especially in a dense air-threat environment, are fleeting in nature. You must see the situation approaching, react quickly to "fine tune" the gun solution, then kill or damage on the first attempt. But think twice about the time and energy dissipation required to generate such a situation if it does not already exist.

#### 4.14.2. Attack the Cripples

Ideally, this would be an inexperienced pilot separated from his flight, low on fuel and energy, with no tally. Time to kill will be minimum in this situation. The bogey you would not choose to gun will be on the opposite end of the spectrum; he is experienced, has energy, fuel, and a tally, and his flight is with him. Minimize all solution errors which are controllable. There is one parameter which minimizes ALL errors associated with a dynamic air combat gun solution range. Get in close to improve your Pk.

Gunshot opportunities in combat are rare. Don't save rounds for other bandits, fire a lethal burst (generally 1 - 2 seconds) on the one you're engaged with, then immediately reposition to avoid the resulting fireball. Once separating, assume you've been targeted by a new threat (you've been very predictable and not checking six while getting your guns kill) and maneuver your jet accordingly.

#### 4.14.3. Gunsights

Four different sighting references are available for use. The gun cross, the lead computing optical sight (LCOS), and the snapshot sight (SS) are available in all F-16s and the enhanced envelope gunsight (EEGS) is an added option in the F16C. Refer to T.O. 1F-16-34-1-1 for information on HUD symbology.

The gun cross is always available and easily used. You can effectively imagine the gun cross as being where the gun barrels are pointed. Proper aim is achieved by positioning the gun cross in the targets plane of motion (POM) with the proper amount of lead. The gun cross is a very good reference to use to initially establish yourself in the target's POM with some amount of lead. As range decreases, you can then refine the lead angle by referencing the LCOS/EEGS pipper before firing. Without EEGS, the gun cross is the only usable reference during very dynamic, high aspect angle shot attempts.

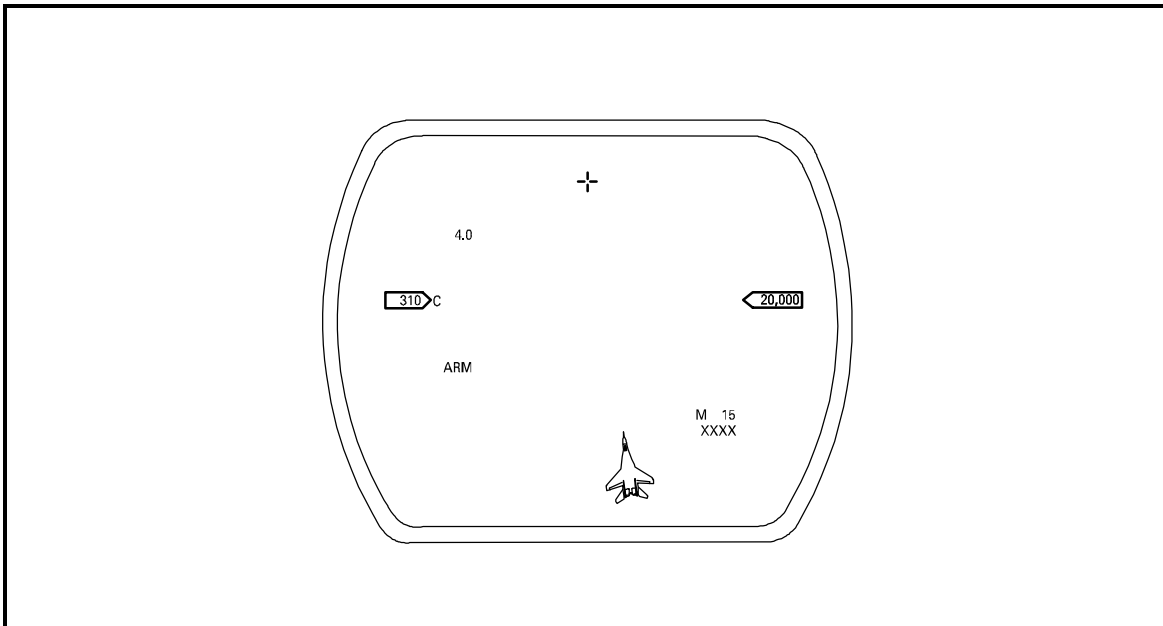
The LCOS pipper represents a sighting reference for which the gun is **now** properly aimed. This pipper helps the pilot establish the proper lead angle to kill the target. The key LCOS assumption is that the pilot is tracking the target with the pipper. In addition, target acceleration and shooter parameters

(airspeed, G, range, and POM) remain constant during one time of flight (TOF). If any of these parameters are changed during the bullet TOF, the pipper will be moving to its new "sight reference" and a solution settling time of one TOF is required.

The snapshot display is a historic tracer gunsight. The principle of the system is to let you see where the bullets would be once they have left the gun. The snapshot algorithm functions completely independent of target parameters except range, which it uses to place the pipper on the continuously computed impact line (CCIL). The key is that the system is historic and not predictive in nature. It is very hard to use as an aiming reference and is not recommended because of the TOF lag in the presentation and the difficulty in managing the sight. However, it does provide an excellent shot evaluation capability. The accuracy of the sight is within 4 - 5 mils at 2000' range as long as you haven't been doing any rapid rolling maneuvers. LCOS and snapshot should always be called up together when employing the gun; use LCOS to aim with and snapshot to evaluate the shot.

The EEGS is a combination LCOS and director gunsight available in F-16C. It provides the capability to accurately employ the gun at all aspects, with or without a radar lock, against an evasive or predictable target, and out to maximum gun effective range.

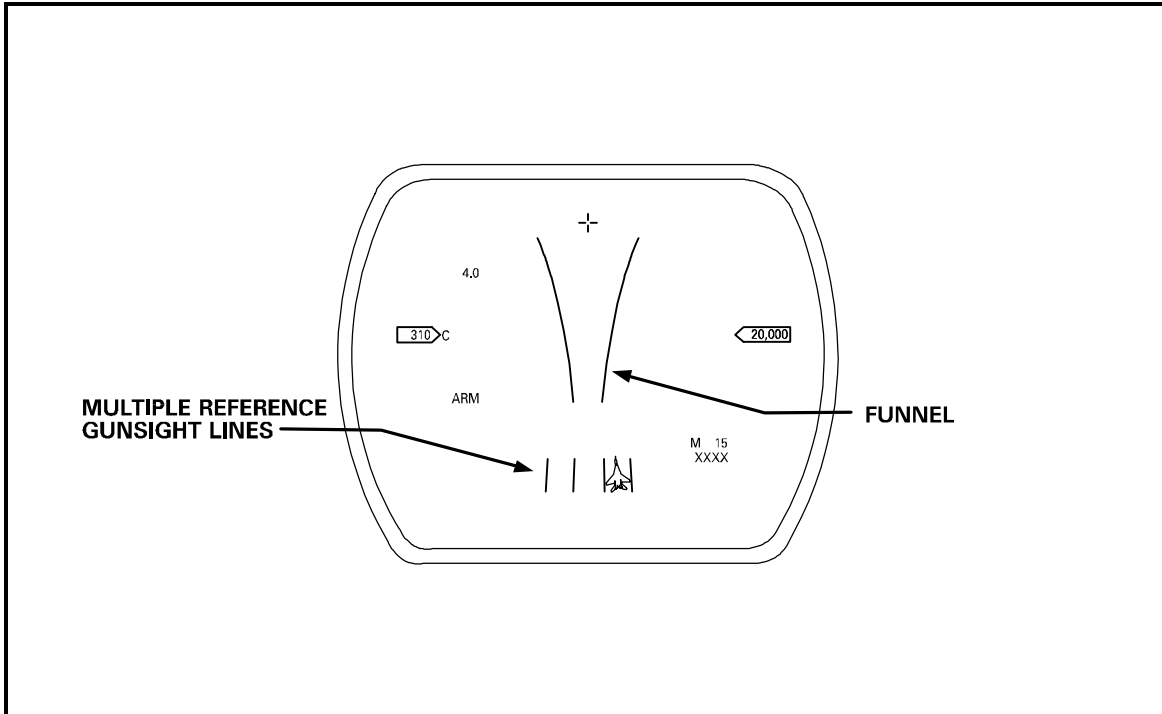
The EEGS consists of five levels of displays, each providing an increasing level of capability depending upon radar knowledge of target parameters (range, velocity, and acceleration). As the radar locks on to the target, the sight symbology smoothly transitions from Level II to Level V, without any large transient motions typical of LCOS mechanization.



**Figure 4.67 Level I Pipper**

#### 4.14.3.1. EEGS Level I

The lowest level of symbology, Level I, consists of the gun cross and is used in the event of HUD or system failure. This symbol is the same as the current LCOS gun cross (Figure 4.67).

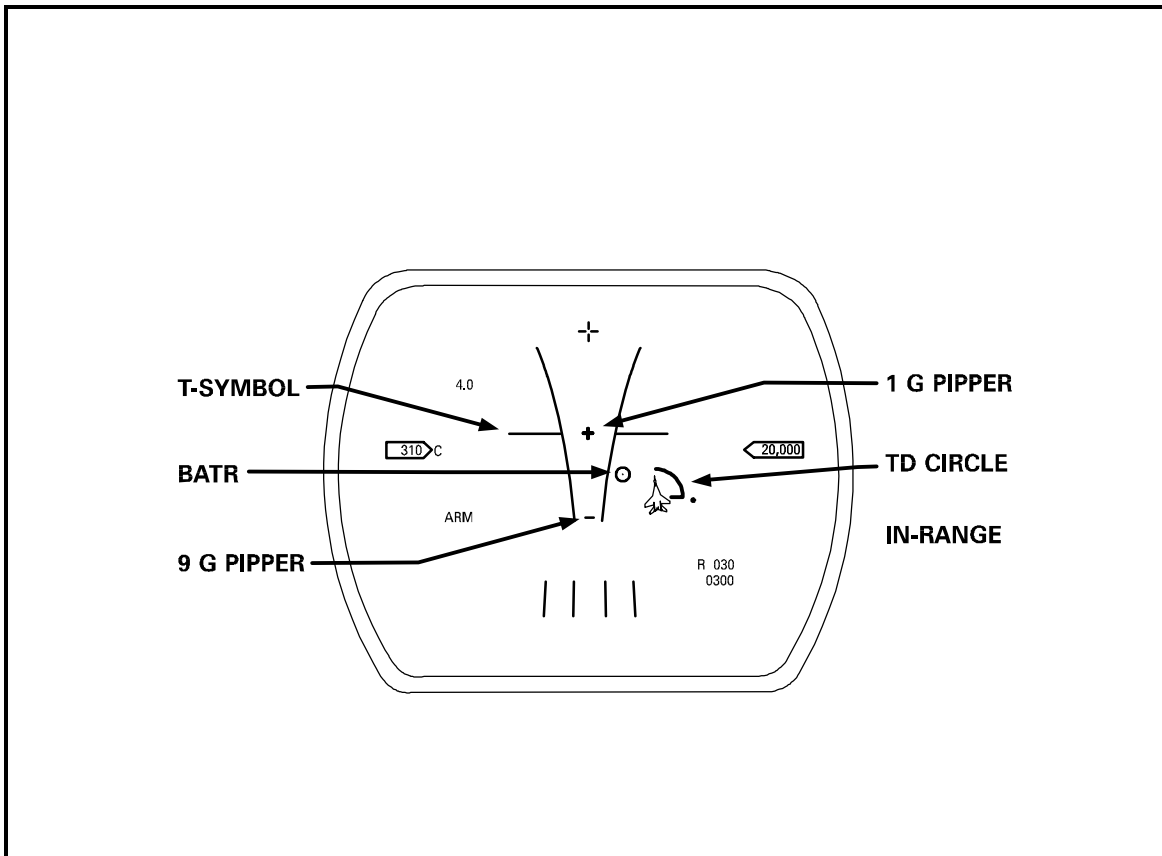


**Figure 4.68 Level II Pipper**

#### 4.14.3.2. EEGS Level II

Level II is the basic no lock symbology (Figure 4.68). It consists of the funnel and the multiple reference gunsight (MRGS) lines. In Levels II and III, the dynamics of the funnel are based on a traditional LCOS system. Ranging can be obtained from wingspan matching. The funnel is used in low aspect (up to 50°) or high aspect (130° to 180°) shots to establish your aircraft in the proper POM and to track the target. The top of the funnel is 600' range and the bottom is between 2500' and 3000', depending upon altitude. An accurate aiming solution exists when (1) the target is being tracked at the point in the funnel where the wingspan is equal to the funnel width (assuming the proper wingspan is set in the DED), and (2) the shooter rate of turn approaches that of the LOS to the target. The only assumption here is that the target is turning into the attack. The pilot is thereby provided a sight with a good estimation of proper lead angle out to approximately 1500', where the width and slope of the funnel decreases to the point where wingspan matching is no longer accurate. The MRGS lines are used in high LOS rate attacks (such as beam aspect against a high speed target) to establish yourself in the targets POM with excess lead. Finally, Level II symbology includes the firing evaluation display system (FEDS), simulated rounds which are fired at the rate of five per second while the trigger is depressed and are displayed on the HUD as dot pairs. The dot pairs move downward across the HUD in the same way that tracers would move had they been fired, and their width corresponds to their current range in mils (based on the DED entered wingspan).

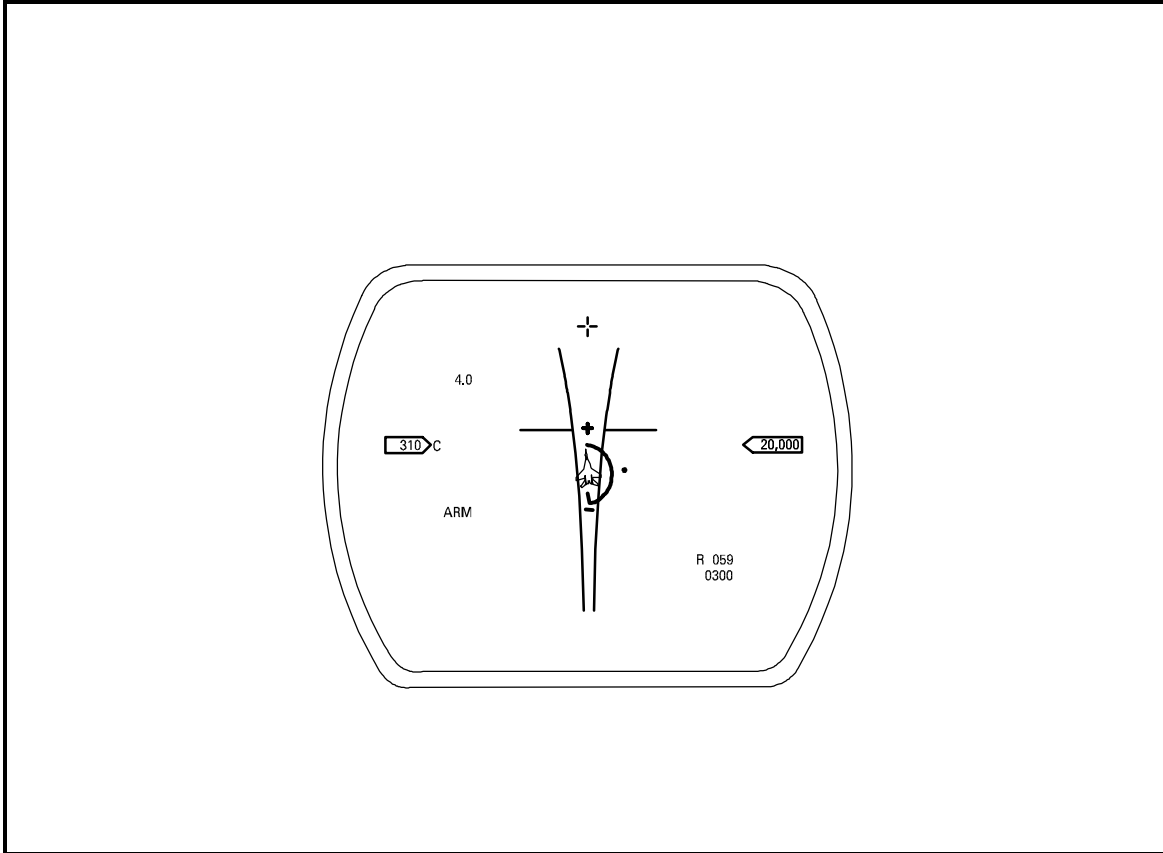




**Figure 4.69 Level III Pipper**

#### 4.14.3.3. EEGS Level III

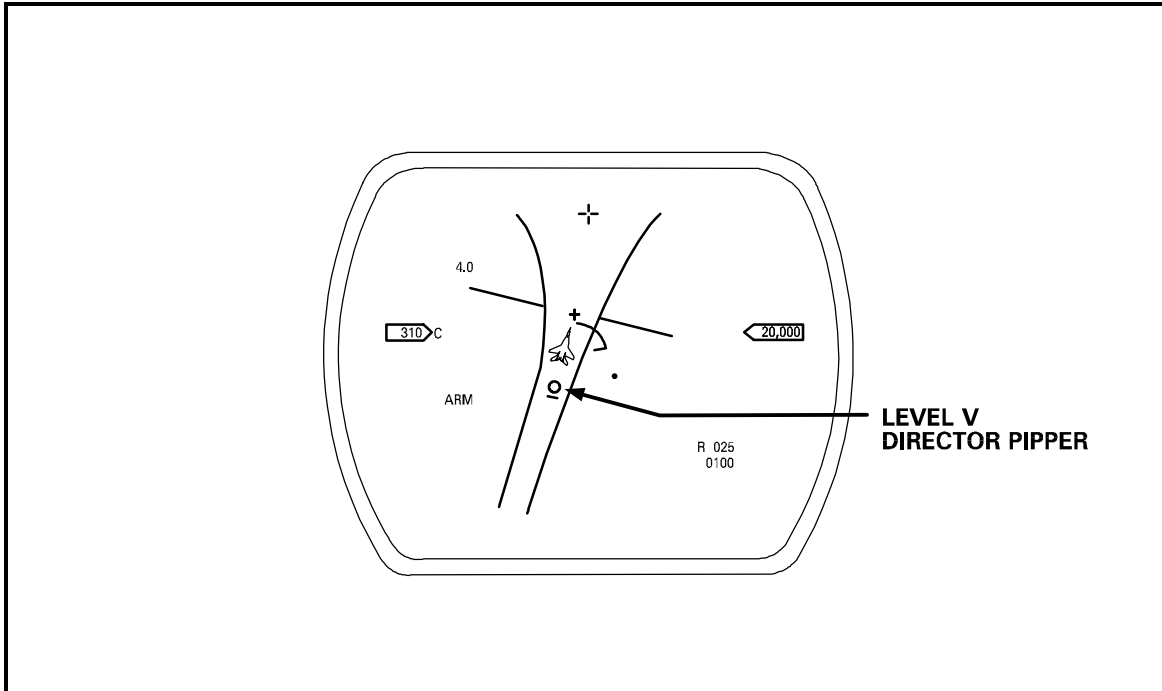
When radar lock-on occurs, target range is the first information available and is the only information needed for the system to smoothly transition to Level III (Figure 4.69). The funnel and MRGS lines are retained and function as in Level II. Four additional references are now also displayed: (1) a target designator (instead of the TD box) is centered on the target and displays a clock analog of target range; (2) a maximum range cue is displayed as a dot on the periphery. It shows the range which corresponds to a 1.5 second bullet time of flight (this ensures the 800'/second bullet impact velocity needed for HEI fuze function); (3) three aiming references are displayed. The small cross is the 1 G pipper and indicates proper lead angle for a constant velocity (straight and level) target. The 9 G pipper is the in-plane maneuver potential line and shows proper lead angle for a target turning at maximum instantaneous rate. The algorithm assumes a maximum G of 7.3 and a corner velocity of 350 KCAS in order to determine this value. This reference (the bar) gives the pilot a well defined lead angle boundary that he can use as a reference in estimating the correct lead angle. Abeam the 1 G pipper are the out-of-plane maneuver potential lines which provide an aiming reference for an evasive target. The end of these lines indicates the potential movement by the target in 1 bullet TOF. Here the algorithm assumes a maximum sustained turn rate of 20°/second at sea level. This turn rate decreases with increases in altitude and airspeed; (4) to assist in shot evaluation a 6 mil circle (corresponding to the gun dispersion) is displayed after squeezing the trigger and show the location of the bullets as they go through the target's range. This bullets at target range (BATR) symbol is used instead of the FEDS whenever valid target range is available and is displayed on the HUD from one TOF after opening fire to one TOF after releasing the trigger.



**Figure 4.70 Level IV Pipper**

#### 4.14.3.4. EEGS Level IV

Shortly after lock-on, the radar will obtain target velocity and the sight will advance to Level IV (Figure 4.70). The sighting references now transition from a pure LCOS sight to a blended LCOS and director sight. A pure director sight is not feasible because at short ranges, radar tracking errors cause the sight to jump around with a random, noisy motion, making it unusable. To smooth out the sight, the system behaves as an LCOS system inside 500' and a combination of LCOS and director systems outside 500'. The entire system, therefore, behaves as a mix of an LCOS solution within 500' and a director solution from 500' out. What this filtering means is the pilot must track the target for about 1/4 second before shooting, or shoot about 1/4 second before the pipper is on the target. The funnel retains its original shape but now responds to target maneuvers and is parallel to the target's POM. The MRGS lines are removed because the funnel now extends to the bottom of the HUD and can be used as an aiming reference at all target aspects. All remaining symbology is the same as in Level III.



**Figure 4.71 Level V Pipper**

#### 4.14.3.5. EEGS Level V

Several seconds after lock-on, the radar can determine target acceleration and the sight will transition to Level V (Figure 4.71). Once range is inside the computed maximum range, a 4 mil Level V pipper appears in the funnel. The Level V pipper uses the radar's estimate of target acceleration and the same LCOS/director blending as the funnel (LCOS lateral aiming error has been eliminated). The Level V pipper is a true "death dot" only in a stabilized solution (remember the 1/4 second settling time) against a target on a **PREDICTABLE FLIGHT PATH** (constant POM, velocity, and G). The funnel and the other symbology remain and are the same as in Level IV.

#### 4.14.4. Employment Considerations

Gunnery errors can be separated into three categories, dispersion, systemic, and pilot controlled errors.

Dispersion is different for each bullet and accounts for the shotgun type of pattern. The dispersion for our gun is six mils, meaning 80% of the bullets can be expected to hit inside of six mils.

Systemic errors result from boresight inaccuracies, radar angle tracking inaccuracies, or any other nonpilot errors. These errors vary from day to day and from aircraft to aircraft and result in a movement of the center of the burst some unknown distance from the aimpoint. In the F-16, the dominant systemic errors come from boresight and radar tracking errors. Boresight errors can be reduced to less than the six mil dispersion with a good boresight program. Radar tracking errors arise from the radar tracking different parts of the aircraft which induces errors in its estimate of velocity and acceleration. However, these errors typically lie along the targets flight path, producing a miss in front of or behind the target. Therefore, the best shooting technique to ensure at least some hits is to strafe the target along its flight path.

The final kind of errors concern pipper position relative to the target, the pilot controlled errors. It is obvious that the pipper must be near the target to get a hit; however, systemic errors may cause a very precise track of the cockpit with the pipper to result in a very precise miss just forward of the nose.

The bottom line regardless of which sighting system is used is that strafing the target along its flight path and firing a lethal burst will compensate for systemic errors and result in a higher probability of hitting and killing the target.

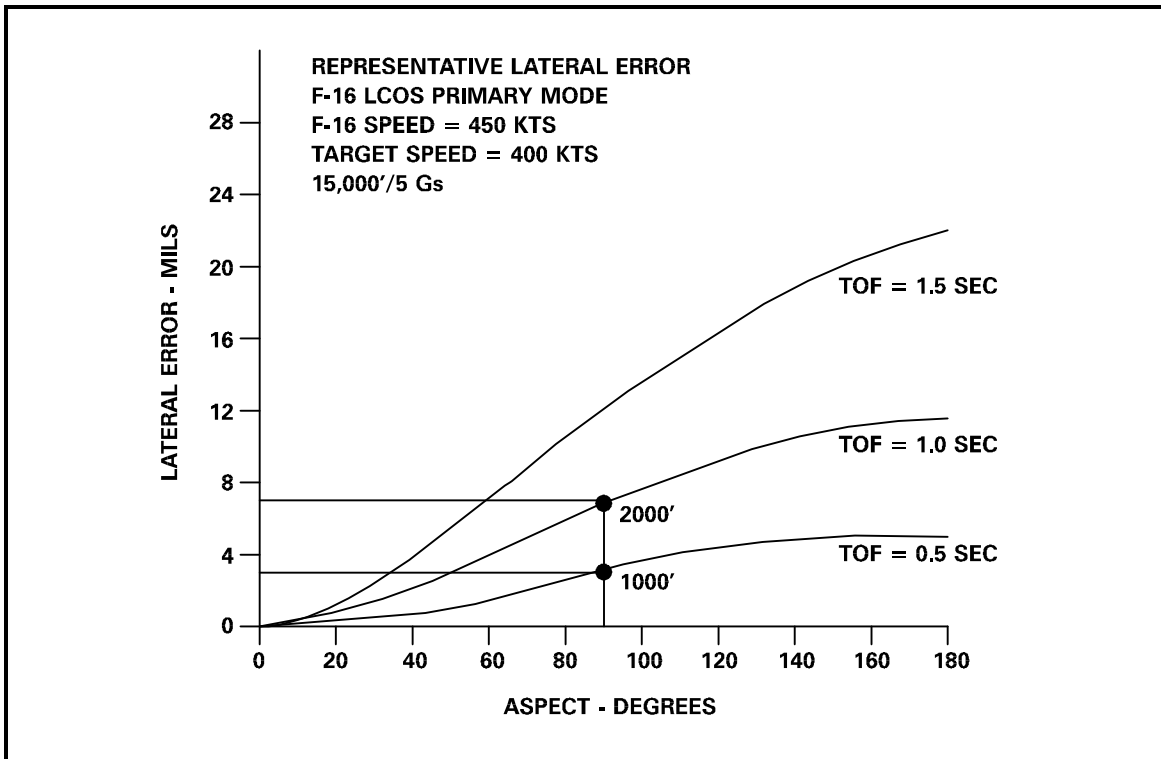
Effective gun employment requires practice and, most of all, mental preparation. The gun must be in the target's plane of motion, gun cross in lead, and in range. Instead of trying to fly the pipper to the target, concentrate on establishing the gun cross in front of the target and in the target's POM. Then, using the LCOS/EEGS pipper as an indicator of the proper lead angle, make small plane and lead angle changes to superimpose the pipper on the target. Open fire before the pipper reaches the target, then strafe the target from one end to the other. If variables change, reposition and press again if the threat allows:

- Watch the target and not the sight. Learn to anticipate sight and target coincidence and open fire one TOF before.
- Do not wish the pipper onto the target. Discipline yourself to fly it to a precise point, open fire, then let it slowly drift through the target.
- Anticipate a target reaction. If the defender maneuvers out-of-plane, accept a snapshot and separate or reposition for another attempt.
- Fire at close range; commensurate with safety and training rules. The shorter the bullet TOF, the more accurate the pipper placement is, and the less reaction time the target has to defeat the shot.
- At cease fire, have a plan. Be ready to reposition or separate if he doesn't blow up.

#### 4.14.5. LCOS Considerations

In LCOS, pipper drift indicates miss vector. This can occur if the pipper is moving in the HUD or if the pipper (stationary in the HUD) is moving in relation to the target. The lag line in LCOS only mode is an indication of this movement. A pipper that is drifting across the target is telling you that you are going to miss the target in the direction of the drift, even if you open fire with the pipper on the target. Pipper drift is a good indication of the miss vector in both direction and magnitude. Settling of the sight is very rapid initially and then slows as it nears the solution. Beyond 2000', LCOS settling time greatly increases, making a stabilized solution more difficult to achieve.

With a full system lock, the LCOS algorithm produces a lateral aiming error at beam aspects. The primary factors in the algorithm induced error are aspect angle and bullet TOF. This error can be reduced by firing at low aspect or from short ranges. Figure 4.72 shows that even at 90° aspect, a 0.5 second TOF shot (approximately 1000') produces only a 3' mil (3') miss, well within tolerance. The same shot, however, at a 1.0 second TOF (approximately 2000') is a 7 mil (14') miss which could be significant.



**Figure 4.72 Lateral Error—Aspect and TOF**

During radar lock transitions, the LCOS pipper jumps to the gun cross while the target state estimator settles. At short ranges, an ACM lock just prior to shooting may cause enough distraction to miss the shot opportunity. A false lock will also cause the pipper to be improperly placed. One technique is to have NAM/RWS selected in DGFT to preclude short-range radar lock and to avoid these undesirable effects.

Without a lock, the system assumes that target G and velocity are equal to shooter G and velocity, that aspect is 0°, and that range to the target is either 700' or 1500' to predict the required lead angle. The aspect and G assumptions produce an overlead situation that is minimized at low aspect and short ranges. The range error caused by the assumption of the preset range can be either overlead or underlead. However, the 1500' option offers more flexibility throughout the entire envelope of typical gun shots (Table 4.1) and should be initially set in.

SIGHT SETTING	TARGET RANGE		
	700'	1500'	2000'
700'	0'	16' AFT	41' AFT
1500'	8' FWD	0'	18' AFT

**Table 4.1 Range Error Miss Distance (700' vs 1500' Range)**

The proper technique when aiming with the LCOS pipper is to establish yourself in the plane of motion early, open fire one bullet TOF prior to the pipper being on the target, then let the pipper drift slowly through the target and cease fire when it reaches the other end.

- Shoot with dual mode LCOS and snapshot. Try to learn to use the LCOS while assessing the snapshot pipper simultaneously.
- Out-of-plane snapshots require the use of the gun cross, **NOT** the LCOS pipper as your primary aiming reference.
- Put the gun cross in front of the target in his plane of motion, then fly it halfway through his top wing.
- Squeeze the trigger when the target is outside 30° of your nose/gun cross to allow for enough lead.

- The more lead you pull, the faster you'll close with the target (watch the training rules).
- Never lose sight of the target. If you have to pull him below the nose to establish lead, you either waited too long or he has too much energy to gun.

#### 4.14.6. EEGS Employment Considerations

For low aspect shots with a radar lock on, a simple technique is to use the 1 G piper to track the target when outside max range. This will establish the plane of motion and solve the majority of the lead angle requirements (remember from basic gun theory that of the total lead angle, about 85% is lead for target velocity and 15% for target acceleration). Using the 1 G piper initially makes it easy to transition to either the in-plane or out-of-plane maneuver lines once you're in range. The pilot then opens fire and strafes the target along its lift vector, using either the in-plane maneuver bar or the out-of-plane maneuver lines as a reference for the lead angle boundary (Figure 4.73).

By using this technique, we are using the best qualities of each part of the system. The radar can get a quick, accurate measurement of target range and velocity but lags in its estimation of acceleration. The pilot is a poor estimator of target range and velocity, but can very quickly perceive a change in acceleration by watching the target's planform and motion. Therefore, by using range and velocity inputs from the radar and acceleration and POM from the pilot's perception, and then strafing the target over the area of uncertainty, we can shoot and even hit targets.

With a full system lock and the Level V piper displayed, the above technique is still valid. The 1 G piper is less noisy than the Level V piper and is much easier to track the target with. Noise can be caused by ECM, chaff, large target size causing pinpoint track confusion, etc. Once in range, if the pilot sees the target remaining predictable, he can then transition to using the Level V piper. You should open fire about 1/4 second before the piper is on the target and then increase G to strafe it from tail to nose (tail aspect).

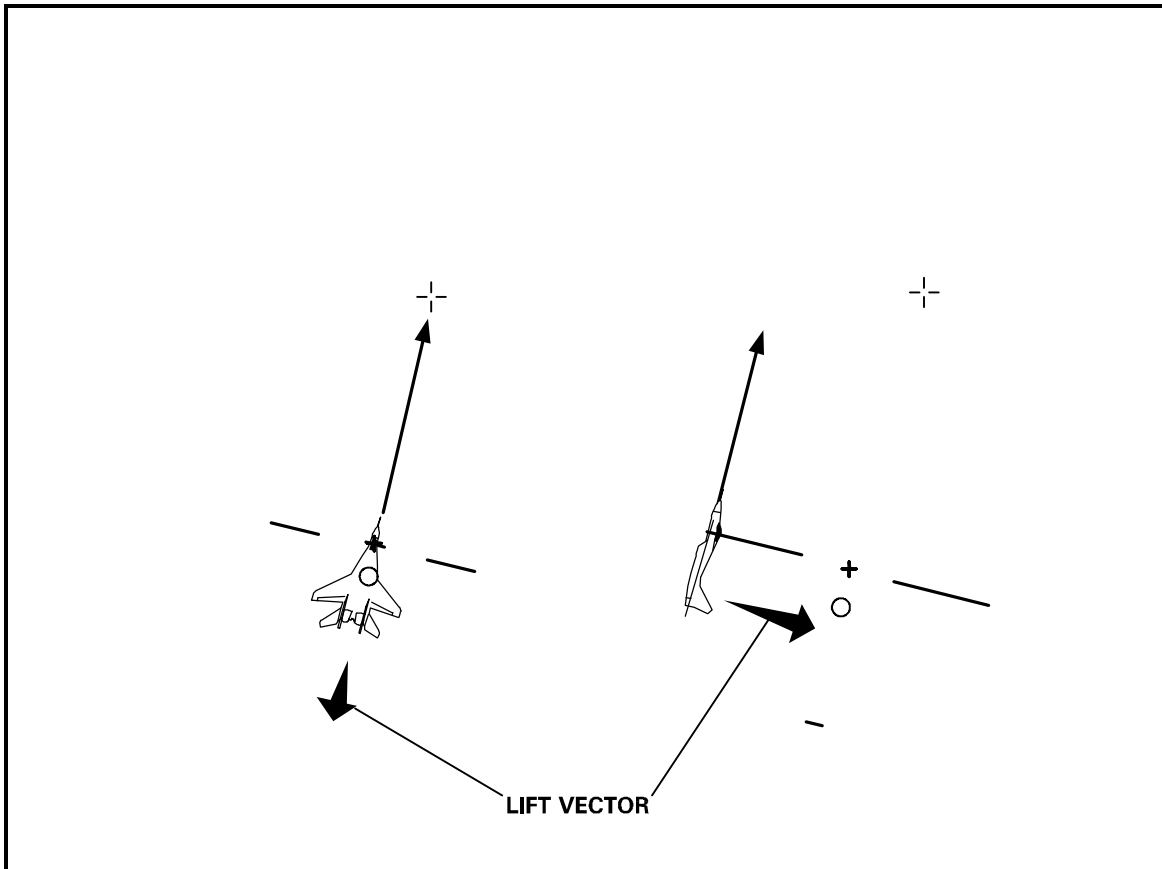


Figure 4.73 Use of 1 G Piper Against Maneuvering Targets

Without a lock, the pilot must use funnel width in relation to the target's wingspan to determine the proper lead angle. An accurate firing burst can be obtained by first centering the target in the funnel. Next, open fire with the wingspan slightly larger or smaller than the funnel, let the target slowly track up or down the funnel, and cease fire when the wingspan is equal to the width of the funnel. It is important to remember that whenever relative motion exists between the funnel and the target, the gun is properly aimed before the target wingspan reaches the width of the funnel due to the LCOS filtering properties.

Next, consider beam aspect shots. The dynamics of beam shots require large lead angles and are difficult because the required turn rate to track the target exceeds the aircraft's turn capability at short ranges. In the 1v1 engagement, a beam shot could result in an exchange of 3/9 line if the shot is missed. However, in a multi-bogey environment, it may not be sound to slow down and anchor in an attempt to achieve a low aspect shot. Against a bomber with a tail gun, a beam/front aspect shot is the best option. For whatever the reasons, a beam aspect shot requires that you establish yourself in plane with excess lead angle early on. In Level II and III, the MRGS lines are used initially to accomplish this by tracking the target on or between any of the MRGS lines. This puts the gun in lead and eliminates lateral error as you close. In Level IV and V, the funnel extends to the bottom of the HUD and is easily used to accomplish this initial lead requirement. This lead angle is maintained until range has decreased to the point where G forces are as high as the pilot is willing to accept or until lateral control is too difficult. Aircraft G is then held constant as the gun is fired and the target moves up in the HUD. In this way, bullets are passing from in front of the target to behind it. Controlling lateral error (keeping the target centered in the funnel) becomes the critical factor, not lead angle.

High aspect shots are very fleeting in nature and are currently restricted above 135° aspect angle. However, in a multi-bogey environment, a high aspect shot and a separation may be the best alternative if you're unable to get a missile shot and are merging at high aspect. Employing the gun in a high aspect attack first requires that the pilot recognize the opportunity for such a shot early on. A pursuit course with the target near the top of the funnel should be initiated so that the shot does not take place with too small a heading crossing angle for a separation during the disengagement. As you approach maximum range (about 5000' at 120°), you should now establish the required lead and open fire. Open fire with the pipper (either Level V pipper or 1 G pipper) coming up from behind the target, pull the pipper through the target, then relax your G's so as to let the target now track back through the pipper. This will create a burst pattern from behind to forward to behind the target. This technique will compensate for any lead angle errors and again make lateral control the critical task. Without a radar lock, the pilot must now analyze range to determine when to open fire. This can be approximated by keeping the target near the lower third of the funnel until the wingspan approaches the size of the bottom of the funnel (approximately 3000'). Now open fire and track the target until the wingspan is larger than the funnel, then relax the G and let the target track up the funnel to ensure sufficient separation.

The gun is an effective, short-range, all-aspect weapon if properly used. You must be mentally aware of what you want to see in terms of gunshot opportunities and take advantage of them as they arise or when you make them happen. Target aspect and geometry are prime players. Know the logic and inherent errors of your gunsight and where to put it for maximum effectiveness.

---

## Chapter Five

### AIR-TO-SURFACE

#### 5.1. The Air-to-Surface Mission

The surface attack mission is the "bread and butter" mission of the F-16. "Hauling iron" is a challenging mission that requires complete knowledge of your aircraft systems, handling characteristics, and ordnance. Given current surface-to-air and air-to-air threat capabilities, the surface attack role is demanding. This chapter presents discussions on premission planning, delivery parameters, surface attack checks, low and medium altitude considerations, visual and non-visual bombing, controlled range patterns, and pop-up deliveries. MCM 3-1, Dash 34 series, and appropriate 55 series manuals should be consulted to further supplement this manual.

## 5.2. Preparation

Contact the flight lead the day prior to the mission and arrive well before brief time ready to mission plan. The game plan and subsequent execution is a direct reflection of the effort put into mission planning. Considerations include but are not limited to:

- Target and desired objectives.
- Threats (surface, air, en route and terminal).
- Aircraft configuration and ordnance load.

With this information, the planning phase can begin. It's important that everyone in the flight participates in the mission planning. Expect duties to be delegated to each member of the flight. Data required to be gathered and produced include the following:

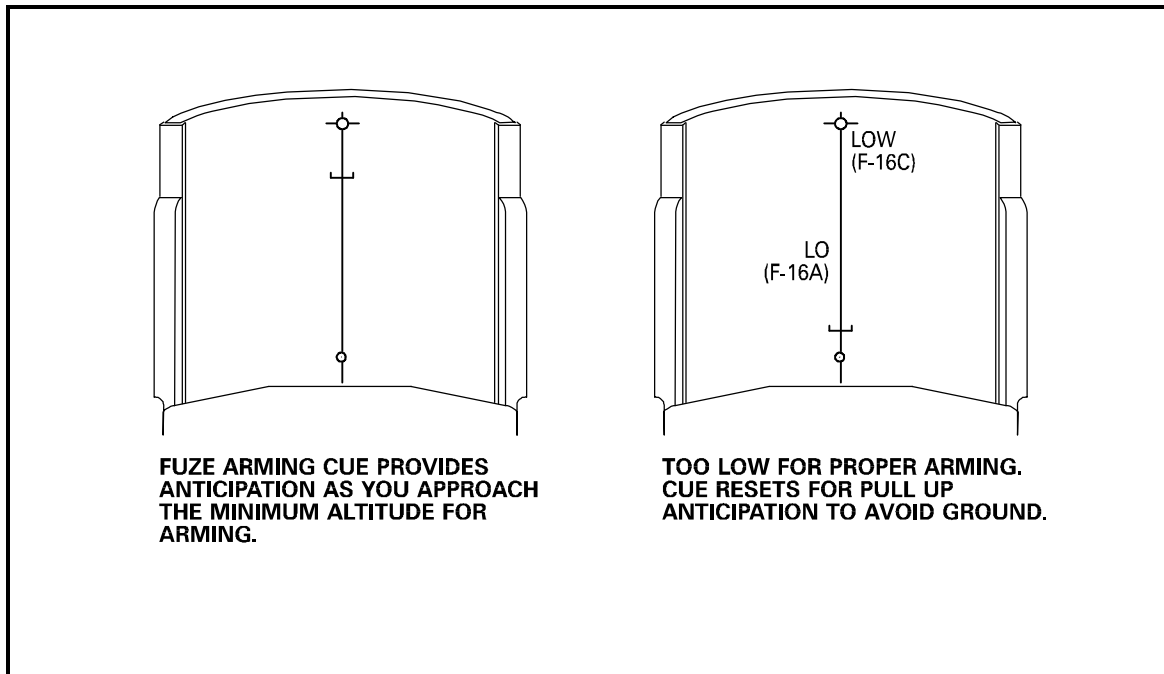
- Weather. Note winds, ceilings, visibilities, and sun angles for the target area and route. Obtain Tactical Decision Aid (TDA) for EO weapon planning and employment.
- Takeoff data should reflect the increased weight and drag of the loaded aircraft.
- Review aircraft and pilot bomb footprint logs to determine if there are any trends that would effect bombing accuracy. For the F-16C/D aircraft, make a note of the aircraft camera coefficients for later comparison.
- Weapons employment data.
- Route and target maps.
- Attack parameters.

## 5.3. Air-To-Ground Mission Planning

Several factors must be considered when planning air-to-ground weapons employment. First, target-munition compatibility must be determined. For example, dropping CBU to destroy a concrete bridge won't work. Second, the delivery must be compatible with the desired weapons effect. If 60° impact angle is desired, its easy to see that a 5° LDGP delivery won't suffice. Refer to the JMEM or ACE planning guide for further weapons effects considerations.

Delivery parameters must be planned with several factors in mind. The release altitude is based on meeting fuze arming requirements, avoiding frag damage/ safe escape, preventing ground clobber and/or adhering to AFI 11-F16 Vol 1 (previously MCR 51-50) restrictions, and avoiding the threat as applicable. Refer to Dash 34 series for an in-depth discussion on these topics. In addition, the Dash 34 will describe the available escape maneuvers: level straight through, climbing, turning safe escape maneuver(s), lateral toss bomb, and backup safe escape maneuvers.





**Figure 5.1 Fuze Arm Warning**

### 5.3.1. Fuze Arm and F-16 Avionics

For impact fuze weapons, the value of the arming delay (AD) entered into the SMS should be the fuze arm time plus tolerance. For example, using a fuze arm time of 4.0 seconds plus 20% (0.8) tolerance, the AD entered in the SMS would be "0480." (AD values are four digit numbers to the nearest hundredth of a second.) If the FCC computes a bomb TOF less than 4.8 seconds, the pull-up anticipation cue resets to provide ground clobber information and "LOW" flashes next to the FPM in the F-16C or "LO" in the left center of the HUD for the F-16A (Figure 5.1).

As long as release (of the last bomb in case of a ripple delivery) occurs prior to the "LO/LOW" indication, the fuze(s) should have time to arm before impact. It is possible that the fuze(s) may arm with less TOF or that bombs may go off "low order," so prudence dictates that safe escape criteria be met. Don't depend on the fuze not arming as a means to frag avoidance.

Arming delay (AD) and burst altitude (BA) values can also be used to provide the FCC with information as to where the weapon ballistics will change. Various fuze categories are shown in Table 5.1

The FCC assumes the weapon(s) will fall in a certain trajectory until the AD or BA conditions are met and the fuze functions to change the ballistics (Figure 5.2). The values of AD or BA in the SMS must be the same as the values set on the weapon fuze to ensure accuracy.

*F-16A (Z1A/Z1B):* AD + fuze arm tolerance + ripple time = SMS time

*F-16C (SCU 2/3, 40T4/5, 50):*  $(N-1)/2 \times \text{INTV} + \text{AD} + \text{fuze arm tolerance} = \text{SMS AD time}$

Now, let's assume that you want a CBU to function at 1800' AGL and the safe separation timer is set at 3.0 seconds on an FMU fuze. To get the ballistic trajectory correct, an 1800' BA must be loaded in "BA" in the SMS. If you also load a 3 second fuze delay time in the "AD" value, the pull-up anticipation cue will indicate when you are approaching minimum altitude to get a 3 second time of flight prior to 1800' AGL height of burst. The big thing to remember is that the values of AD or BA in the SMS must be the same as the values set on the weapon fuze.

If you are using a weapon such as CBU or Rockeye for instance, the SMS is smart enough to know that the AD value you load is really what's on the weapon. If you want the munition to function at a particular burst altitude (BA) to optimize coverage, you need only load that altitude in the SMS and the pull-up anticipation cue will function to let you know when you reach that (minimum) altitude. In this sense, the

pull-up anticipation cue is not trying to satisfy a minimum fuze arm constraint, but is trying to indicate the optimum release point to ensure the correct function altitude.

FUZE CAT 1		FUZE CAT 2		FUZE CAT 3		FUZE CAT 4	
WEAPON	ID	WEAPON	ID	WEAPON	ID	WEAPON	ID
MK-36	050	BSU-49B	072	BL-755(AD)	094	MK-20(AD)	090
M-192E2	052	BSU-49BL	074	CBU-52(AD)	098		
MK-106	054	MK-82BA	076	CBU-58(AD)	102		
BLU-27	060/061	MK-82SBA	078	CBU-71(AD)	106		
BLU-52	062	MK-82BALD	080	CBU-87(AD)	110		
MC-16	063	BSU-50B	082	CBU-89(AD)	112		
BDU-33	065/066	BSU-50BL	084				
MATRA-250	070	MK-84BA	086				
BSU-49	071	MK-20(BA)	091				
BSU-49L	073	BL-755(BA)	095				
MK-82	075	CBU-52(BA)	099				
MK-82S	077	CBU-58(BA)	103				
MK-82SLD	079	CBU-71(BA)	107				
BSU-50	081	CBU-87(BA)	111				
BSU-50L	083	CBU-89(BA)	113				
MK-84	085						
GBU-10	180/183						
GBU-12	186						

Table 5.1 Weapons by Fuze Category

Finally, if you have Rockeye (MK 20) munitions, you can load two separate values of AD corresponding to the primary (AD1, NOSE) or secondary (AD2, NSTL) option timers. As you cycle between NSTL and NOSE, the function times change to reflect this.

Note that if "TAIL" is selected for CBU type munitions, the weapon will DUD. The significance of the "TAIL" entry in Figure 5.2, fuze category 2, is to let you know that if you want the pull-up cue to be responsive to changed parameters, select the "TAIL" option, load in the new parameters, and then go back to "NSTL" or "NOSE" as appropriate. Sounds complicated, but the first time you use the system in flight, you'll get the hang of it.

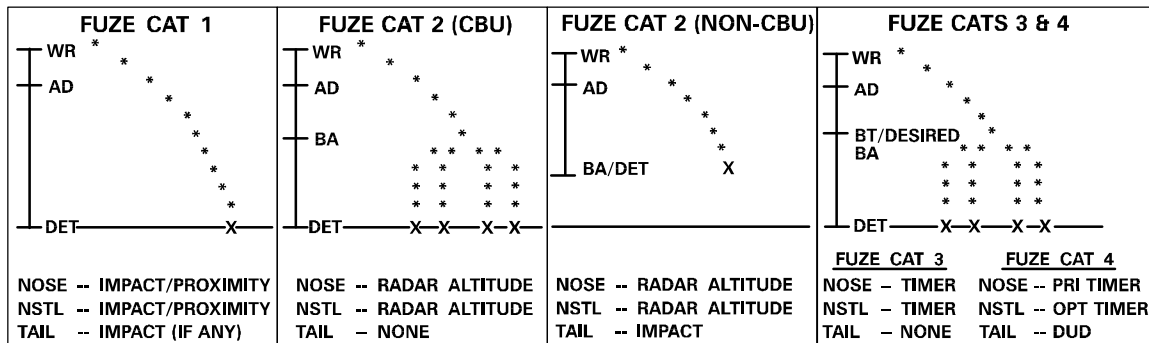


Figure 5.2 Fuze Categories

### 5.3.2. Safe Escape And F-16 Avionics

The F-16 HUD and radar displays will provide an indication of when a recovery is required to avoid ground clobber. You can also load an AD/BA in the SMS to provide a HUD display ("LO/LOW") when release parameters result in bomb TOF less than that required for fuze arm/function. What the FCC does NOT do is compute a minimum altitude for safe escape. This is the pilot's responsibility and can be done only by reference to the safe escape tables in the Dash 34. For example, if an AD of 4.4 seconds was loaded into the SMS and a ripple six level delivery (straight and level escape maneuver) was performed at 500 KTAS and 500' AGL, the delivery would be below minimum frag clearance criteria but there would be no HUD indications because the fuze would have sufficient time to arm prior to impact.

This discussion of fuze arming, safe escape, and ground clearance may have seemed complicated, but we can't stress its importance enough. When the weather's good, the F-16 circular error of probability (CEP) will usually get the job done without requiring you to get very low. But, with low ceilings, we might not have a choice but to deliver visually underneath. In this context, this discussion is very pertinent.

## 5.4. Surface Attack Checks

### 5.4.1. Ordnance Preflight

Allow extra time for ordnance preflight. If you find a problem, you'll need the time to have weapons correct the problem and still make your start engine time. Since munitions problems are not uncommon, you may want to do your weapons preflight as soon as you arrive at the aircraft. Contact the weapons supervisor immediately and inform your flight lead of any problems.

- Be sure the load matches the planned configuration.
- Use your Dash 34 checklist to preflight ordnance.
- If you plan to use the gun, make sure the gun electrical safety pin is installed outside the purge door, the safety tool/wire is removed, rounds counter set, rounds limiter switch turned on (peacetime only), and AFTO 781 form is annotated "HOT GUN."
- Note canopy coefficients prior to start and confirm they're loaded correctly in the FCC.
- After engine start, verify the SMS inventory. Weapon/stores (quantity zero) can be entered on empty stations for simulated deliveries or system checks.

### 5.4.2. After Start Checks

#### 5.4.2.1. INS "Swing" Check

When the INS alignment is complete, it is a good technique to run through all the programmed destinations and compare bearing and distance from present positions with precomputed values on your card.

#### 5.4.2.2. Accelerometer Check

Errors in the INS horizontal and vertical accelerometers will result in navigation and bombing errors.

#### 5.4.2.3. Ground Speed (GS) Check

GS on the INS should read zero after alignment. Any GS reading other than zero when you are still in the chocks indicates errors in the horizontal accelerometer(s). These errors will result in navigation and bombing errors. If GS reads greater than zero immediately after alignment, do another alignment.

#### 5.4.2.4. Vertical Velocity Indicator (VVI) Check

Note the position of the VVI in the HUD. Any reading other than zero indicates a bad vertical accelerometer which will result in erratic twelve and six o'clock errors.

#### 5.4.2.5. Camera Check (F-16C)

In order to verify proper camera coefficients, a ground stabilized camera check is recommended on every sortie in which VTR assessment will be used. Turn the VTR to HUD, switch on, turn the master arm switch to SIMULATE, and select A-G master mode with DTOS symbology displayed. Also display

the HUD and camera coefficients. Move the DTOS box to various easily seen ground references in the HUD FOV and aurally document pipper placement. Place the DTOS box in the lower portion of the HUD, approximately 5°–10° nose low and within the airspeed and altitude scales. This is where most of the A-G bombing takes place. Post-flight review of this check will enable the pilot to determine mil displacement if the camera coefficients are in error.

#### 5.4.3. End Of Runway (EOR) Check

After stopping at EOR, confirm all weapons switches safe and keep hands in full view during arming. Remember that aircraft should not taxi in front of aircraft with forward firing ordnance being armed or dearmed.

- As soon as you stop in the arming area, check your GS and HUD VVI.
- If GS is zero or one knot, the INS platform is good. Press on.
- If GS is two or more, the platform alignment is bad. If possible, accomplish another alignment.
- RLG-equipped aircraft can perform an extended interruptive alignment (EIA) if desired.
- Verify or correct your system altitude after the EPU check.

#### 5.4.4. Airborne Ordnance Check

The bomb check or battle damage check is normally done shortly after takeoff and when leaving the range. It is done only in daytime and is a visual confirmation of bomb condition/expenditure. The checking pilot visually inspects each aircraft for hung ordnance, "spinners," and battle damage. After completing the inspection, he returns to his original position and is inspected by another pilot in the flight. A battle damage check should also be done on every sortie when clear of the target area.

#### 5.4.5. Airborne Computed Checks

##### 5.4.5.1. Air-to-Air System Check

While performing an air-to-air system check, the pilot should note the position of the target aircraft in the TD box. A target not appearing in the TD box could indicate either a bad radar boresight or a bad HUD boresight.

##### 5.4.5.2. Radar Ranging Check

If time permits during the descent to a low level, or on one of the early legs of a low level, the pilot should check whether or not the air-to-ground ranging (AGR) function is working. With the master arm in SIMULATE, select CCIP and observe the CCIP pipper while flying over relatively smooth terrain. The pipper should track smoothly. If movement is jittery, the AGR is probably breaking lock and the system reverting to barometric (BARO) ranging. The FCR should indicate a valid lock-on to the ground by displaying a diamond symbol on the REO/MFD. Slant range should be displayed in the HUD and remain relatively constant. If the tactical situation allows, a roll in can be simulated to determine how quickly the AGR is locking on.

##### 5.4.5.3. Dive Toss Check

During the initial descent to low level, a check of the DTOS can be made. As in the CCIP mode, the pilot can assess the AGR capability of the system. The pilot should designate a target and begin a pull-off, noting the reaction of the TD box. Usually it will move toward twelve o'clock as the pilot begins his pull, then back toward the target. Motion back toward the target indicates the vertical accelerometer is functioning correctly. Continued motion towards twelve o'clock means problems. Vertical accelerometer errors can be minimized by delivering at closer slant range to the target. The steeper the bomb impact angle, the less the effect of system altitude and vertical velocity errors.

##### 5.4.5.4. GS and Winds Check

Comparison of these values among flight members may provide valuable data concerning a grossly malfunctioning system.

- GS should be within two knots.

- Winds should be comparable; however, if winds are light, direction and magnitude may vary considerably and be of little use.
- If GSs are similar but winds are different, suspect a CADC problem.

#### 5.4.5.5. Altitude Calibration (ACAL)

Anytime you suspect errors in system altitude, an ACAL should be performed before bombing. However, avoid using the FCR for an ACAL if you have known AGR radar problems.

#### 5.4.5.6. G-tolerance, Loss of Consciousness, and Preparation

A dedicated G-awareness exercise should be conducted IAW Chapter 9 on all missions when required IAW AFI 11-214.

### 5.5. Ingress/Egress

#### 5.5.1. Fence Check

Certain items should be checked to ensure that switches and avionics are set up properly prior to entering a hostile area. This may be just beyond the field boundary, so it may be necessary to do some of these checks prior to takeoff. Others may be delayed until just prior to the push out of the orbit, mission dependent. The following items should be checked as a minimum. Whether you use the following example is not the point, accomplishing the items is. One way to assure you make a thorough check of your combat capabilities and are ready to fight, is by using the word FENCE as an acronym:

- **F** Fuel. Check balance, total, NORM feed and tank inerting selected. *NOTE:* Tank inerting may cause slow external fuel transfer.
- **E** Emitters. Use the acronym TRAIL
  - **T** TACAN. Check operation. A/A set as briefed.
  - **R** Radar. Set CCR and altitude coverage as briefed.
  - **A** ALQ & ALR. Set proper ECM technique and RWR as required.
  - **I** IFF. Set modes, codes, and Auto/Man as required.
  - **L** Lights. All exterior off.
- **N** Navigation. INS check/verify steerpoints. Confirm GPS/Nav status High/High (Block 40/50). Accomplish update (FIX/ACAL) if necessary on preplanned point.
- **C** Chaff and flares. Check programmer prior to strapping in. ARM and check operation airborne.
- **E** Employment. Recheck SMS programming to include DGFT, MSL OVRRD, AIM-120 BIT and ID set as briefed, AIM-9 cooling/tones, and rail priority. Check arming options to include weapon, fuze arming option, release pulses, spacing, and delivery modes. Ensure Master Arm is set as required, HUD has correct symbology, proper arm indication, and SOI/SOR in proper place. Confirm TGP laser code is set IAW mission requirements and Arm as required. Turn up volumes on missile, RWR, UHF, VHF, and secure voice to desired levels.

As you can see, a complex mission will also have a complex FENCE check. Omission of even a single item could result in a dry pass, a missed shot opportunity, or even risk being shot down due to no flares or ECM. It may be helpful to write down critical FENCE check items on your mission card.

#### 5.5.2. Low Altitude Considerations

The use of the low altitude structure is one method of target area ingress and egress. How low to fly and how long to fly there is determined by the objective for using the low altitude structure. Flying low reduces the lethal engagement zone of some surface-to-air threats. Flying low reduces some early warning capabilities and offers a degree of tactical surprise. Selective use of the low altitude structure is an effective method of getting to and from target areas, when thoroughly planned and executed. Flying low is not a panacea for every tactical problem. Do not fly lower than the altitude where you can safely and effectively perform all assigned tasks. Refer to MCM 3-1 Vol II for specific threat capabilities. Refer to Chapter 7 for low altitude navigation operations.

Depending on the threat scenario, fly at an altitude that safely balances detection, threat avoidance, and cockpit operations. This regime allows the flight to avoid the ground, navigate, and conduct visual look out. Maneuvering tactical formations at low altitude is a difficult task requiring a high degree of skill and proficiency. Checking six, monitoring the radar, and interpreting defensive systems are difficult and become degraded when compared to these activities at higher altitudes. The advantages of operating at low altitude must be weighed against the inherent disadvantages when deciding to maneuver in this regime. Flying at extremely low altitude (100 feet AGL) should only be performed when absolutely necessary.

Advantages of low altitude operations:

- Detection by threats may be delayed.
- Exposure time to surface-to-air threats is reduced. Threat systems are restricted to line-of-sight. Terrain degrades the detection and tracking capabilities of many systems.
- Many air-to-air threats have little or no radar and missile capability at low and very low altitudes. Look down/shoot down fighters provide a low altitude capability, but all weapons systems have reduced effectiveness at low altitude.
- Below the weather operations are possible if the threat allows.

Disadvantages of low altitude operations:

- Proximity to the ground is the most significant disadvantage. Demand on your flying skills is greater than at higher altitudes.
- Navigation can be more difficult. You see much less of the "big picture" and can quickly become disoriented regarding your position, or confused by intentional alterations of the target area. Task saturation, due to low altitude operations, degrades time available to concentrate on position analysis.
- Fuel flow increases significantly at low altitude. As such, combat radius is reduced. Missions requiring extended periods of low altitude operations require thorough mission planning to ensure sufficient fuel is available. Tankers may or may not be available.
- Low altitude operations put you in the heart of AAA engagement zones.

### 5.5.3. Medium Altitude Considerations

Flying at medium altitude is another viable option for target area ingress and egress in certain circumstances. The same planning process must occur when selecting the altitude flown. Threat avoidance, early warning detection and aircraft performance are but a few considerations.

The same techniques for dead reckoning and map reading at low altitude apply at medium altitude with the exception of these qualifiers at higher altitudes. It's easier to see the "big picture" in front of the jet. However, the road/bridge turnpoint may be difficult to see from medium altitude. Turnpoints must be selected on the basis of distinct identification from higher altitudes. For example, choose the major highway interchange versus the dirt road/railroad intersection, or the mountain peak versus the small ridge. Weather must be considered as well (for example, low fog).

Medium altitude ingress allows the pilot, based on task load, to look inside for longer periods of time. Radar work will be easier because more time is available to monitor the display. Medium altitude may be the correct option when the major threat is AAA.

Advantages of Medium Altitude:

- Better range/endurance potential.
- Threat avoidance from certain systems; especially light AAA.
- Easier navigation when weather is not a factor.
- Higher potential energy.
- More time available to work aircraft systems and to interpret and recognize details from target study.
- Simpler attack geometry is possible.

Disadvantages of Medium Altitude:

- Vulnerable to certain threat systems.
- Easier detection by threat due to radar LOS.
- Threat is not isolated above you; 3D threat attack axis exists.
- Less aircraft performance dependent on configuration.
- A-A missiles have longer ranges.

### 5.6. Computed Visual Bombing

Although the computed weapons delivery capability of the F-16 can make up for sloppy pilots, the system can get bombs closer to the target by flying smooth, accurate parameters. The planned parameters ensure frag clearance, desired impact angle, fuze arming, or burst/function altitude for weapons. Varying dive angles changes fuze arm, safe escape, and minimum recovery altitudes. A running aim-off distance (AOD) due to improper dive angle G can produce an excessively fast piper ground track and prevent a good bombing solution. Holding AOD slows the piper ground track rate and provides a better bombing solution which improves accuracy.

#### 5.6.1. Choosing a Delivery Option

The F-16, with its sophisticated avionics package, gives the pilot several visual bomb delivery options. The method of delivery is dependent upon the aircraft systems available. Specifically, the ordnance can be released in the following ways:

- Computed Delivery
  - CCIP
  - DTOS/Backup DTOS (F-16A)
  - STRAFE
- Manual Delivery
  - Manual delivery with HUD and computer.
  - Manual delivery with HUD and without computer.
  - Manual delivery without HUD or computer.

Full computed delivery is preferred due to its accuracy and independence from precalculated dive angles, airspeeds, altitudes, and winds. Computed delivery is dependent, however, upon the following:

- An operable computer.
- Accurate INS fine alignment (good INS velocities).
- An accurate ranging reference (radar or system altitude).

If the FCC computer is inoperative, there is no choice other than to deliver manually. This can be done with the help of the HUD, which will still provide airspeed and altitude scales along with pitch lines and FPM. If AGR is bad (or the FCR has failed), go BARO by turning the FCR to STBY. BARO requires an accurate system altitude. Perform a RALT ACAL if so equipped.

#### 5.6.2. DMPI Selection

Potential adversaries have the capability of employing camouflage, concealment, and deception (CCD) techniques to confuse the attacker, causing him to miss the DMPI or even abort the attack. These are particularly effective against visual attacks where viewing time is very restricted. Typical of inexpensive, easily employed disruptive techniques are tonedown, disruption of geometric shapes and patterns, and the introduction of a false aimpoint in the target vicinity. Expect to encounter a combination of these techniques protecting fixed or relocatable ground facilities.

#### 5.6.3. Dive Recovery

Any ordnance delivery requires a proper recovery for two basic reasons: (1) to avoid the weapon frag envelope and (2) to avoid hitting the ground. Perform the correct planned recovery maneuver on every pass, as described in the Dash 34. If you release below the planned altitude to compensate for incorrect

release parameters, the standard recovery may no longer be valid. You will have to use more G to effect a safe recovery, and this is not the right answer. Plan to release at or above the minimum release altitude or abort the delivery.

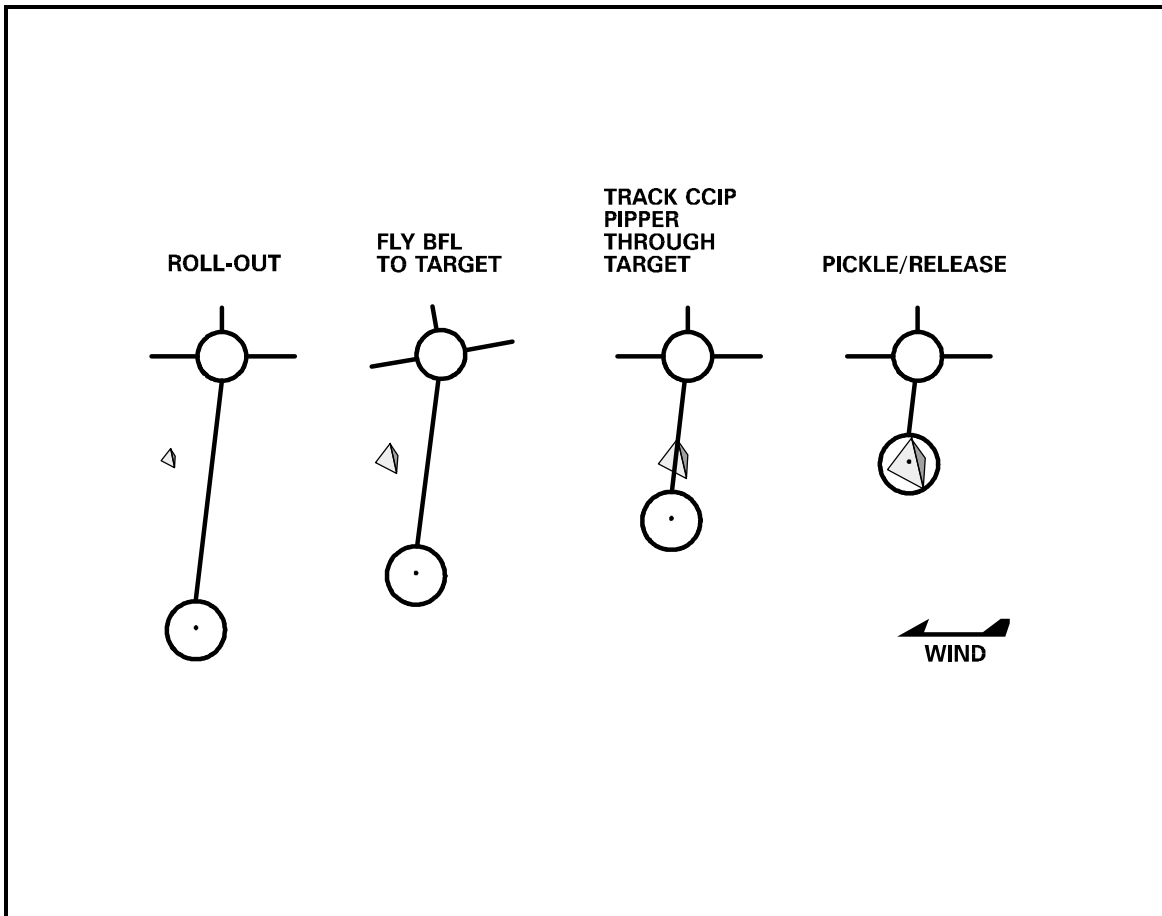
#### 5.6.4. **Continuously Computed Impact Point (CCIP)**

Initiate the CCIP delivery mode by selecting air-to-ground, the appropriate attack profile, and CCIP. If you're in another delivery mode, you can select CCIP by depressing the NWS button as required. Verify the correct weapon, single/pair option, number of release pulses, spacing, and fuzing selection. Place the master arm switch to MASTER ARM and check for a SMS RDY indication and CCIP and ARM in the HUD. Select the target steerpoint to ensure correct target elevation if the system reverts to BARO.

Use a smooth roll in and roll out, compensating for the wind and turn radius. Disregard the bomb fall line (BFL) and CCIP pipper during the roll in. Concentrate on rolling out with the gun cross close to your aim-off point (no wind), for crosswind conditions, aim slightly upwind of the aim-off point. After roll-out and HUD symbology settles, set the aim-off distance (AOD) by the target-to-BFL relationship. This will pay off in the tactical environment. Once the initial pipper placement/aim-off point has been set, hold the FPM on that spot and allow the CCIP pipper to approach the target as you steer out any azimuth errors. Don't pull the FPM up in an effort to rush the pass. This "banana pass" will result in a higher than planned release, and degrades delivery accuracy.

Remember, 3 to 5 seconds on final is fast enough, don't rush it any more than that by "pulling" the pipper up to the target (Figure 5.3). If you find the pipper will not get to the target prior to minimum release altitude, decrease the dive angle by raising the AOD to ensure pickup by the minimum release altitude. Once established wings level with the FPM at twelve o'clock to the target, the BFL should be near the target. Fly the aircraft to put the target under the BFL. Correct as necessary to keep the BFL through the target and allow the CCIP pipper to smoothly track up to the target. Avoid the common error of allowing the nose to rise and thus move the FPM beyond the desired aim-off point.

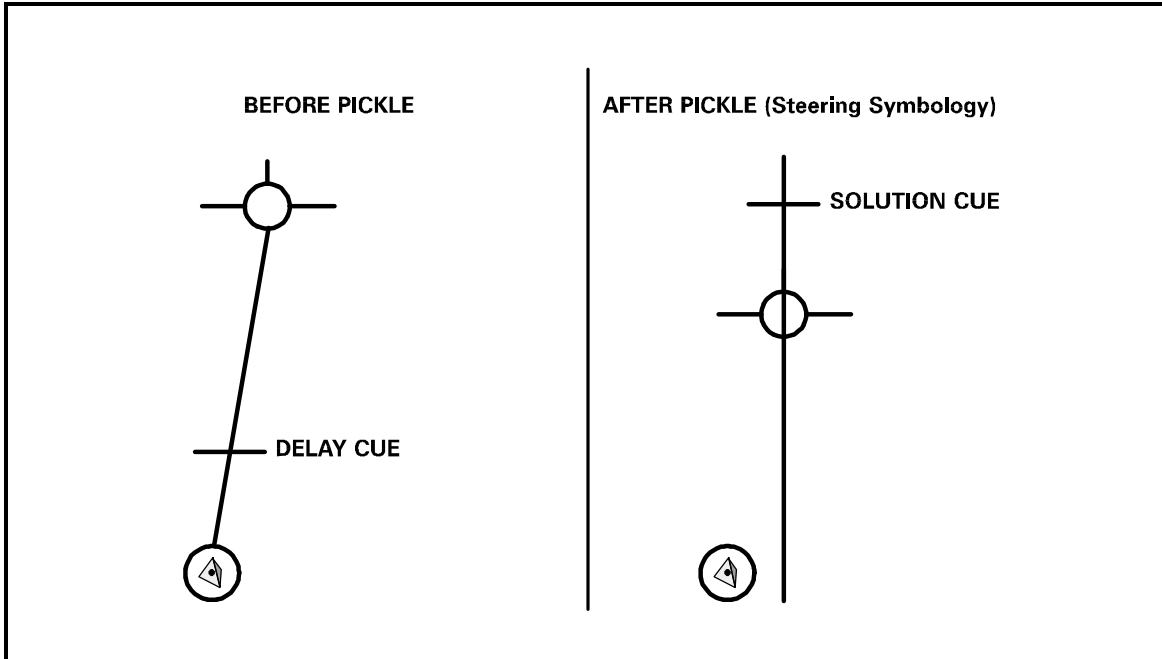




**Figure 5.3 CCIP**

Pickle when the CCIP pipper reaches the target. Pickle and hold your release G until all bombs are released. Avoid the tendency to “quick pickle” as this could inhibit release with a delay cue or result in a partial release.

Since the CCIP mode is a computed bombing mode, the effects of winds are automatically compensated for by the wind model in the FCC. Your job as the pilot is to get the pipper over the target and to do that, you need to consider the winds. The headwind/tailwind component is corrected for in the computer by moving the CCIP pipper up or down along the BFL and thus is not of main concern to the pilot. Most of the crosswind correction is made by drift stabilization of the FPM and associated symbology. As long as the drift cutout switch is in the NORM position, the technique of placing the FPM upwind, and the BFL through the target will cause the nose of the aircraft to be crabbed into the wind. This crabbing causes the aircraft to fly over the target, thus compensating for most of the crosswind. However, with strong winds and/or high drag weapons, there will be additional corrections required to account for bomb trail. The BFL will be sloped to the downwind side. Under these conditions you may wish to place the BFL slightly upwind of the target on the initial roll out. Do not use drift cutout while in the CCIP mode. If drift cutout is selected, the FPM and BFL will not be displaced downwind; however, the pipper will still show the impact point. Thus, the line between the FPM and pipper will be angled excessively and you'll find yourself in a near-constant bank to keep the target under the BFL.



**Figure 5.4 Delayed Release**

#### 5.6.4.1. CCIP Delayed Release

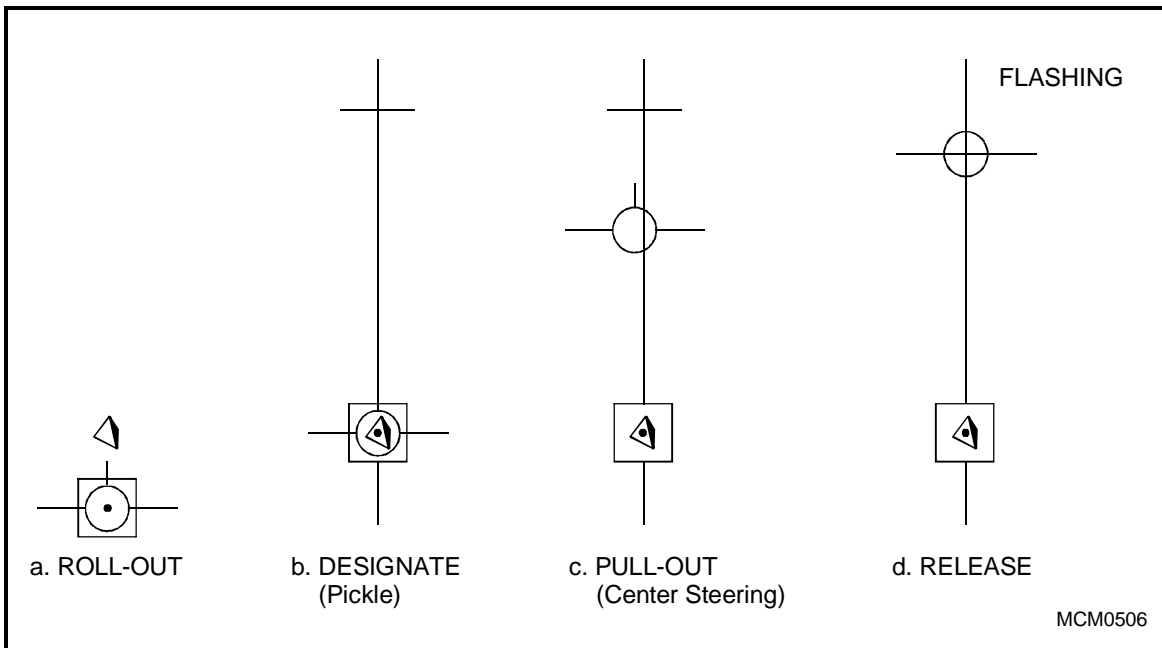
For release conditions where the bomb impact point is under the nose of the aircraft, the CCIP piper cannot be positioned low enough in the HUD at the instantaneous impact point. In this situation, the CCIP piper is positioned approximately  $14^\circ$  below the boresight cross and a time delay is computed, based on the difference between the piper position and the actual impact point. The presence of the delay cue indicates that this situation exists. This delivery is exactly the same as the normal release up to the point of pickle. If the time delay cue is present, hold the pickle button depressed. Steering symbology, similar to postdesignate DTOS steering symbology, will appear except the CCIP piper will replace the TD box (Figure 5.4). Fly the FPM to the steering line to null any steering error (just as in a DTOS delivery) while holding the pickle button down. Release will occur when the solution cue reaches the FPM. In most situations the delay will be very short, i.e., less than 1 second, and you may even miss the postdesignate symbology prior to release. Your indication that release has occurred is a flashing FPM. It is a good habit to hold the pickle button down until well after the FPM flashes. This ensures that you will get all bombs off when rippling a string of bombs. **WARNING:** Release the pickle button before switching to an air-to-air mode. If live missiles are loaded, you will fire the selected AAM.

#### 5.6.5. Dive Toss (DTOS)

The DTOS mode is used primarily to accomplish Low Altitude Toss (LAT) or Medium Altitude Toss (MAT) deliveries. Initiate DTOS by selecting air-to-ground, the appropriate attack profile for the weapon, and the DTOS delivery mode. The NWS button can be used to step to DTOS from CCIP or CCRP. Verify single/pairs release pulses, spacing, and fuzing. Recheck master arm switch to MASTER ARM, RDY on SMS, and DTOS and ARM in the HUD. You probably want AGR, so check that the FCR is not in OFF/STBY/OVRD (F-16C). Plan a longer final than is used for CCIP or manual events. Also check the steerpoint you've selected. If the radar works properly, the steerpoint won't be important. But, if the radar breaks lock for 3 seconds, the FCC will use the elevation of the steerpoint as the target elevation when computing a BARO solution. Roll in using a smooth roll out, compensating for wind and turn radius. Roll out on final with the aircraft flight path directly in line with the target. Pickle/designate to ground stabilize the TD box and slew it to the target. Be aware of and avoid slewing to a release solution due to over controlling. Fly out the azimuth error and ensure you hold the pickle button down when the solution cue approaches the flight path marker. Execute a safe escape recovery after bomb release occurs.

and/or in time to adhere to recovery minimums. Know your minimum stand-off range and don't violate it!

The post-designate DTOS HUD symbology is depicted in Figure 5.5. The TD box is ground stabilized over the target. Azimuth errors are controlled by steering the flight path marker to the steering line. When the target is at maximum toss range, a solution cue appears on the HUD along the steering line. The maximum toss solution is based on the assumption that an instantaneous 5 G pull will be made to a 45° climb angle. Pulling greater than 5 G's may result in short bombs or no release at all and, with some weapons, may exceed the stores limits. During a long range DTOS delivery, a maximum toss anticipation cue (100 milliradian circle) is displayed on the HUD 2 seconds prior to the solution cue display. When the solution cue is displayed, the anticipation cue flashes for 2 seconds, then disappears. Time-to-go to release is displayed in the lower right corner of the HUD. Bearing (in tens of degrees) and range to target are also displayed. As time-to-go approaches zero, the solution cue will move downward toward the flight path marker. Automatic release occurs when the solution cue intersects the center of the flight path marker, provided the pickle button is depressed. The flight path marker will flash at release.



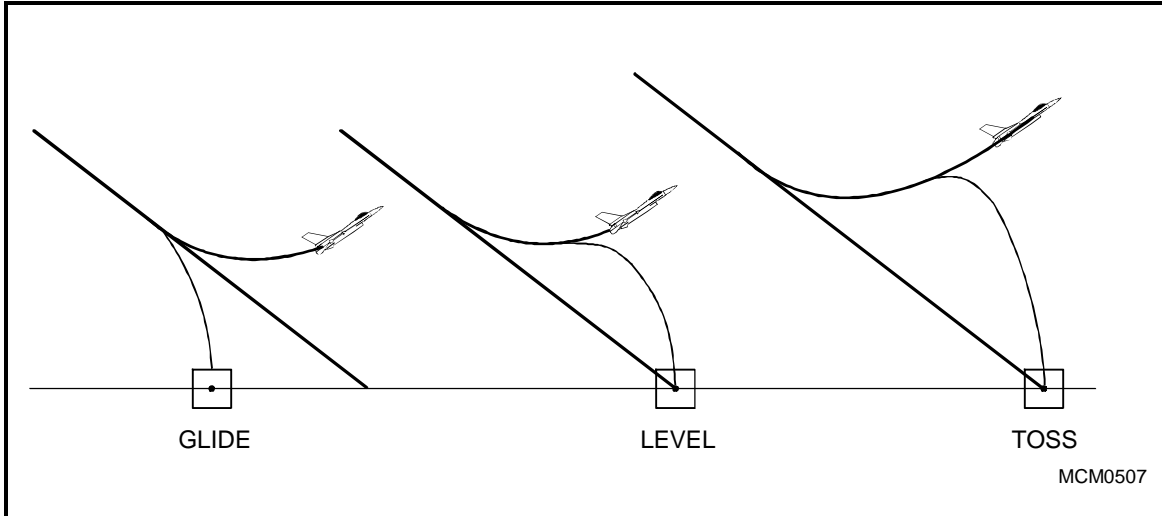
**Figure 5.5 Postdesignate DTOS Symbology**

#### 5.6.5.1. Point-blank aiming

Point-blank aiming (TD box on FPM) is the simplest DTOS method from a mechanical pilot skill standpoint. You can also "preslew" the TD box below the FPM. Some pilots find this helps them get the TD box on the target, but be aware of pendulum effect. When you designate, the TD box becomes ground stabilized and you can continue to slew to refine aiming. Designating with the pickle button and holding it until release is the easiest method. If you designate with the designate button, you'll have to depress the pickle button prior to the solution cue reaching the FPM. Hold the pickle button depressed until the solution cue intersects the FPM and the FPM begins to flash to indicate release. The FPM will continue to flash until you release the pickle button.

Initiate a smooth pull keeping the FPM centered on the steering line. You should continue to pull to remain above minimum release altitude. This can result in a toss, glide, or level release (Figure 5.6). After designation in point-blank aiming, watch the TD box for drift as you approach release. If toward six or twelve o'clock, an error is probable. If drift is small, you can refine aiming using the radar cursor/enable button to place the TD box back on the target. Note that movement toward twelve o'clock, followed by movement toward six o'clock is normal. If the TD box is off more than 5000' laterally, the release will be inhibited. You may reage the TD box by either exiting the DTOS mode or selecting

return to search (RTS). If you choose not to recage, the TD box will remain ground stabilized. INS drift may cause the TD box to move.

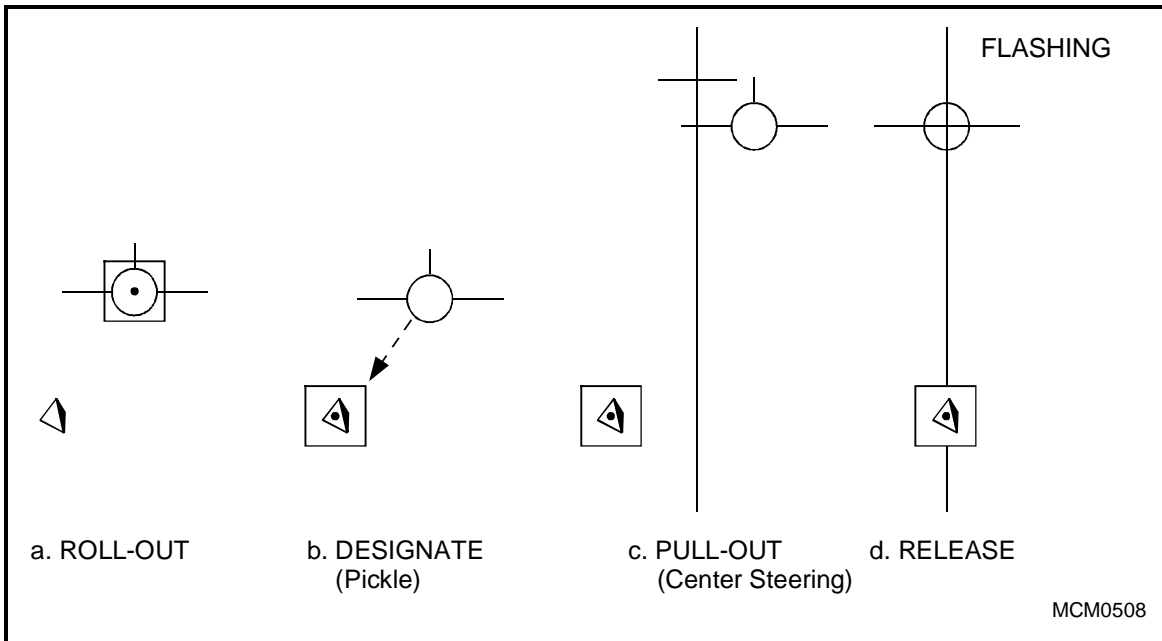


**Figure 5.6 DTOS Release**

#### 5.6.5.2. Slew Aiming

This method of aiming (Figure 5.7) provides maximum flexibility in tactical situations, but mastery is most difficult. It is possible to slew aim regardless of aircraft attitude as long as the aimpoint is within the HUD FOV. Remember that directional control of the TD box is always referenced to aircraft attitude. Develop slew aiming skill as follows:

- Roll out on final with the TD box on or near the target. One good technique is to roll out with the TD box short of the target and smoothly pull it up to the target.
- Ground stabilize the TD box (designate or pickle).
- Adjust power, if necessary, before you start to slew.
- Slew the TD box directly toward the target aimpoint. Move the cursor/enable button as if you were slewing the radar cursors.
- "Fly" the FPM toward the steering line and roll out when they coincide.



**Figure 5.7 Slew Aiming**

Observe the solution cue progress, keep the FPM on the steering line, and complete the delivery as described in point-blank aiming. If you have neglected to fly out the azimuth error while slew aiming and the solution cue is approaching the center of the FPM, you have three options:

- Abort the release (thumb off pickle button).
- Accept the error. If the error is more than 5000' laterally, the release will be inhibited.
- Fly out as much error as you can and accept the result. This is usually better than aborting the pass. The closer the FPM is to the steering line, the better. Be careful not to violate current Dash 1 release limitations for the type bomb you are dropping.

You can continue to slew after designation. In this case the TD box is ground stabilized so that you are moving it over the ground rather than in relation to the FPM. In addition, each time you slew, the FCC takes a new range sample. Be extremely careful when slewing with the pickle button depressed; if you slew too quickly to six o'clock, the system may "see" a solution and release before you have a chance to correct.

#### 5.6.5.3. Backup DTOS (F-16A)

Even with certain HUD electronic unit (EU) failures, you can still do computed visual bombing. Activate this mode by selecting DTOS on the SCP, selecting the standby reticle, and turning the HUD power OFF. When you do this the FCC configures the avionics for DTOS with the radar fixed at the fuselage reference line (zero mils on the STBY reticle). This allows you to use the STBY reticle to aim the radar at the target. The computer drops the bomb during the pullout, but you must estimate the azimuth to get your flight path over the target or use the steering line displayed in the REO. Use the following steps for backup DTOS:

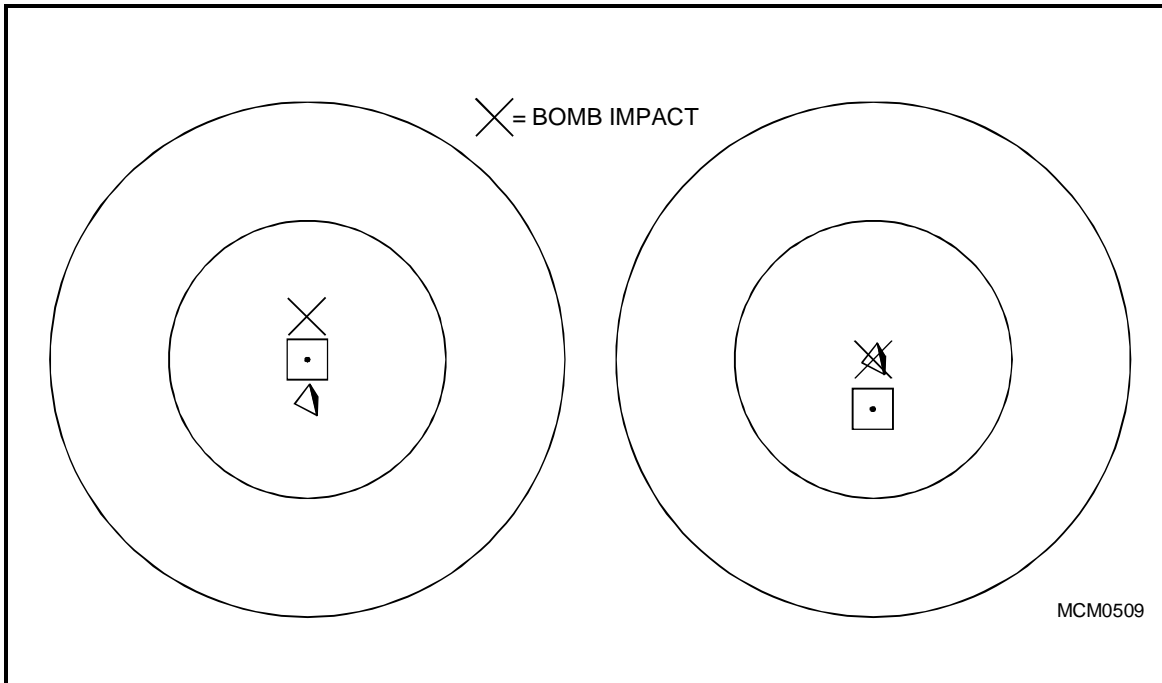
- DTOS mode—select (DTOS on SCP and master arm to MASTER ARM).
- HUD intensity/power—OFF.
- STBY reticle—ON and set to 0 mils.
- Mode entry can be confirmed by looking in the REO for the AGR maltese cross and antenna in boresight (zero azimuth and elevation).
- Confirm system in predesignate.

- Predesignate is confirmed by observing the steering in the lower left corner of the REO. You should be in predesignate at mode entry, but can confirm it by noting that there is no vertical steering bar.
- Roll in and track target with STBY reticle.
- Designate (pickle) when piper is on target.
- Pull out by flying as required to get your aircraft over the target while holding the pickle button down.

If you know the crosswind at release, you can displace the piper into the wind at designate and make a wings level pullout. The amount of displacement should be the same as the crosswind correction factor for manual bombing or approximately two mils/knot if you don't know that factor. If you are working a long range delivery, you may have time to look at the steering line on the REO and make corrections using it in the same way you would have used the FPM and steering line in the HUD. Time-to-go to release will also be displayed in the REO. Release is confirmed by feel or by the "REL" on the SCP. If multiple passes are being made, reinitialize.

#### 5.6.6. Computed Bombing Error Management

While the complexity of the system does not allow for easy error analysis, there is a way to organize computed error analysis which will not only improve your bombs (Figure 5.8), but also result in better write-ups, and better systems lead to better bombs. There are three main sources of error when the F-16 drops a bomb: you, the INS, or ranging.



**Figure 5.8 DTOS Error Correction**

Before you blame the INS or change the ranging mode, check yourself:

- Did you really designate/pickle with the TD box/CCIP piper stabilized on the desired aimpoint?
- Were you pushing and pulling on the stick after designation?
- Accurate error analysis depends on having consistent parameters on each pass.

Once satisfied that you are not the problem, there are some things you can do to determine whether the INS or the ranging mode is at fault. The first step is to understand these basic principles:

- Ranging errors cause six/twelve o'clock misses only.
- INS errors may be in any direction.
- The magnitude of an INS error depends on the time from designation to bomb impact.

#### 5.6.6.1. CCIP Analysis

The most common method for CCIP error analysis is the actual bomb impact versus the piper placement at pickle. Large misses short or long are probably a ranging problem. Small misses short or long could be a ranging problem or boresight error. Rule of thumb: to correct a known error simply correct that same distance in the opposite direction.

The previous discussion should serve to give you an awareness of the types of errors and their symptoms, but the main thing you need to know is what to do in order to get the "bull." You may have noticed in the previous discussion that no matter what the source of error was, the solution for the next pass was to adjust your aimpoint. This applies to CCIP as well as DTOS. You simply "go to school" on your first bomb. Rule of thumb: to correct a **known error** simply aim that distance in the opposite direction.

#### 5.6.6.2. Canopy Coefficients

Canopy coefficients are applied to the CCIP piper and TD box, but not to the BFL. This sometimes results in what appears to be a misalignment of the symbology under certain conditions. For example, the CCIP piper may not appear exactly on the end of the BFL. This is not unusual. Use the CCIP piper for aiming even if it is slightly misaligned with the BFL.

*F-16A:* The FCC uses a series of correction factors to account for the optical distortion of the canopy. These coefficients are checked/entered through the FCNP, data knob—MISC, data opt—C12, C34, C56, C7. These numbers are unique to each canopy and are usually found on a plate on the canopy rail in the eleven o'clock position. If the numbers on the canopy do not match the numbers in the FCNP, then you can expect bombing errors. You can check/change them with a standard keyboard operation.

*F-16C:* In the F-16C, three sets of coefficients correct for canopy and camera errors. The first two, HUD and CTVS, are listed on the canopy. Squadron weapons should have a current listing of the camera corrections which are the final set of values that need to be verified. Verification is accomplished by accessing the list menu and miscellaneous page for corrections. If the numbers are different, insert the new numbers into the FCC.

#### 5.6.7. Computed Bombing Considerations

Your selection of a ranging mode is critical when it comes to optimizing your hit probability. There are several factors which affect your choice of a ranging mode. Is AGR working, is system altitude off, or are there radar jammers in the target area? If the target is in the midst of extremely rough terrain that will cause rapid and frequent changes in AGR computed range/piper position, it may be best to go BARO or use DTOS instead of CCIP. A proper air-to-ground system check accomplished prior to the target is crucial for determining the optimum delivery mode.

Assuming all modes are operating properly, radar is the primary ranging mode. If using point-blank aiming, do not designate early unless you plan to slew for refinement because the last ranging sample will have been at designation.

If you suspect AGR is in error or is inconsistent, and your system altitude is reasonable, BARO ranging may be preferable to radar ranging. It is critical that the elevation of the waypoint in the thumbwheel be equal to the elevation of the target. The effect of ranging and system altitude errors decreases with increased bomb impact angles.

### 5.7. Manual Weapons Delivery

In the event of complete system degradation, you may be forced to resort to manual bombing. Good manual bombing demands rigid compliance with delivery parameters. There are many conditions which might force you into a manual delivery. Some of these conditions might allow limited use of the HUD (such as FCC failure), but in general you will only have the standby reticle and heads down instruments. If the HUD is operational, then the FPM and scales may be very useful in establishing parameters.

#### 5.7.1. Preparation and Planning

The following items should be accomplished even if manual bombing isn't planned. You never know when you might need to go manual.

Before the flight:

- Complete weapons employment data (aim-off distance, mil setting, initial pipper placement) on the line-up card.
- Obtain current/forecast winds for each event.
- Compute an upwind aimpoint for the pipper at release.
- Determine the mil correction headwind/tailwind factors.

At the aircraft:

- Turn on the standby reticle, confirm the aiming reticle is visible and depressible to the maximum mil setting required for the flight.
- On a dedicated manual bombing flight, if the sight is not visible or will not depress, attempt to get a spare aircraft. The mil depression rings may be used for approximating a mil setting if the pipper will not depress.

### 5.7.2. Range Entry

The following steps will ensure you're ready and switches are set properly:

- If possible, reference INS (or your wingman's) for winds at altitude.
- Obtain the latest surface winds if possible.
- As necessary, recompute the upwind aimpoint for each event or the headwind/tailwind mil correction factors.
- Setup SMS, position the master arm to MASTER ARM, and set the mil depression for the event to be flown.
- Review parameters for the events to be flown.

### 5.7.3. Base Leg

The range wind (head/tail) determines the amount and direction of base leg position shift into the wind from the no-wind figures (Figure 5.9). The amount is dependent on the strength of the wind at both release and roll-in altitudes. Generally you should move your base leg into the wind by about three times your computed upwind aimpoint. When you roll out on the adjusted base position, use crab to maintain that distance as you approach the roll in. Lead the turn to base to roll out at the right place.

### 5.7.4. Final

When you are tracking toward the correct roll-in point, start thinking about when to begin the roll in.

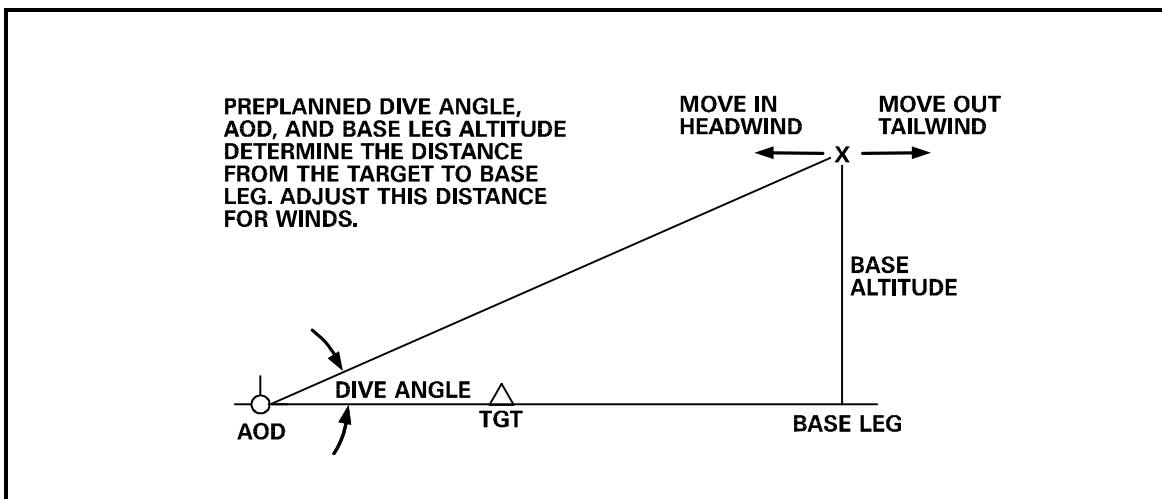
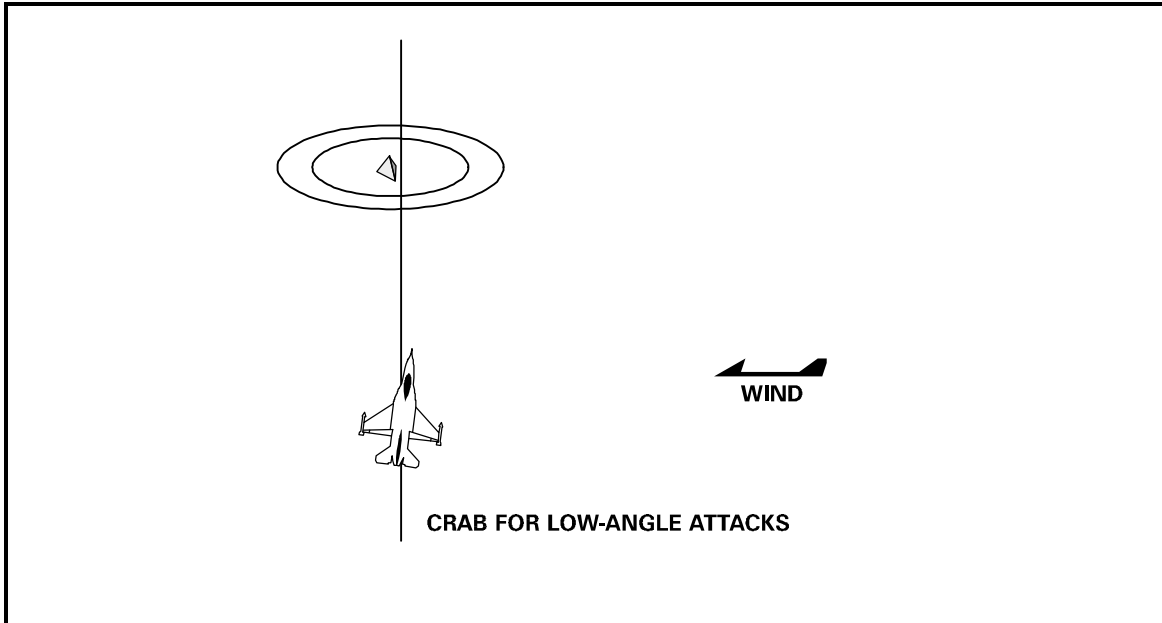


Figure 5.9 Base Leg Position





**Figure 5.10 Low Angle Crab Correction**

**5.7.4.1. Crab**

If you're going to crab (recommended for low-angle deliveries), roll out directly on an extension of the attack direction line (Figure 5.10). This is called the attack axis.

**5.7.4.2. Drift**

If you're going to drift (recommended for high angle deliveries), use the "rule of three." This rule of thumb will position the aircraft upwind so that the bomb track is pointed toward the target with the aircraft heading parallel to the attack direction (Figure 5.11). Look at the target and the release aimpoint. Imagine a line through the aimpoint parallel to the attack direction extending on back to base leg. You will want to be over this line at release. The distance between this line and the target represents the lateral drift of the aircraft and bomb during the time from release to impact. The time from roll out to release will be about twice this, as will the distance drifted during that time. Therefore, you will want to roll out upwind from the target, about three times the release offset distance. Reference this distance to the release aimpoint and imagine another line parallel to the first, twice as far upwind. Roll out over this second line.



Observe the rate of pipper track and altimeter decrease. If an accurate IPP has been set, the pipper would arrive at the upwind aimpoint at the preplanned altitude, airspeed, and dive angle. Since all these parameters are seldom met perfectly, you will have to adjust pickle altitude and/or sight picture to compensate. One technique of adjusting release for incorrect dive angle is to relate the change to a release altitude adjustment. With the correct AOD/IPP set, for every 1° steep, pickle 100' above your planned release altitude. This is a generalization that applies to all dive angles, with the intent of being easy to remember. **Never** release below your set minimum release altitude (MRA).

#### 5.7.6. High Altitude Manual Bombing

The high altitude bombing pattern is similar to the normal 30° pattern. On base, monitor the target over the canopy rail; remember the sight picture for future use. Mentally prepare for the delivery by determining the aim-off point, initial pipper placement, and bomb release sight picture. Be aware of the fact that although your pattern is high, your dive angle is steeper, thus you accelerate more rapidly. The tendency to press is normal because of the higher pattern; do not press below your minimum release altitude. Remember the reason for high altitude bombing is to avoid the small arms envelope.

#### 5.7.7. Manual Low-Angle Bombing Events

The major differences between low-angle, low-drag and low-angle, high-drag deliveries are the release altitude and aim-off distances. Low-drag events have higher release altitude and a longer AOD. For level deliveries, a crabbing approach is recommended versus a drifting approach for all level deliveries. It requires less effort to fly yourself over the target.

While high drag ordnance is generally released closer to the target than low drag ordnance, high drags have a longer bomb trail. The bottom line in crab vs drift approaches is to fly the aircraft over an upwind point so that the **bomb** hits the target.

#### 5.7.8. Error Analysis

Since it is difficult to attain all the required release parameters simultaneously, you must understand the effect on bomb impact caused by not attaining one or more of the release parameters (Table 5.2). Error analysis is essentially the same for all bomb deliveries; however, different dive angles produce errors of varying magnitude. Dive bomb errors do not usually happen singly; i.e., a steep dive angle results in a lower release altitude and higher airspeed by the time you get the pipper on the target. The result is an unbelievably long hit. When discussing error analysis, we assume the pipper is on the target with all but one of the other delivery parameters met. The following errors affect accuracy: dive angle, release altitude, airspeed, G loading, bank angle, and skid.

FUNCTION	AMOUNT	10°	15° LAB	20° LALD	30°	45°	45° H
AIRSPEED	+20 KTS	58' L	37' L	109' L	63' L	65' L	112' L
	-20 KTS	64' S	86' S	114' S	85' S	60' S	128' S
ALTITUDE	+100'	77' S	49' S	61' S	27' S	5' S	8' S
	-100'	58' L	39' L	46' L	16' L	18' L	22' L
	+200'	15.7' S	105' S	122' S	51' S	16' S	23' S
	-200'	93' L	70' L	94' L	36' L	28' L	37' L
	+500'	525' S	311' S	330' S	123' S	56' S	70' S
	-500'	N/A	N/A	207' L	98' L	58' L	77' L
DIVE ANGLE	+5°	62' L	66' L	154' L	103' L	82' L	235' L
	-5°	286' S	186' S	308' S	189' S	130' S	309' S
BANK	2°	34' LR 16' S	30' LR 14' S	72' LR 29' S	43' LR 12' S	32' LR 5' S	75' LR 10' S
	5°	83' LR 44' S	73' LR 34' S	178' LR 78' S	105' LR 32' S	79' LR 14' S	185' LR 30' S
	10°	159' LR 95' S	140' LR 73' S	342' LR 170' S	205' LR 72' S	156' LR 35' S	366' LR 76' S
G-LOADING	+¼ G	33' S	33' S	74' S	49' S	38' S	70' S
	-¼ G	68' L	60' L	68' L	48' L	50' L	82' L
NOTE: L = Long Impact; S = Short Impact; LR = Lateral							

**Table 5.2 Conventional Error Analysis Comparison**

#### 5.7.8.1. Dive Angle

If correct aim-off distance is not established and release is made with the sight on target at the preplanned release altitude, impact errors caused by dive angle deviations are the largest and therefore most critical. As shown in Figure 5.12, a steeper than planned dive angle places the aircraft further forward in space when the pipper arrives on the target. This is the release-point range error. In this situation, bomb trajectory is flattened, but not enough to compensate for the release-point range error and a long hit results. The opposite effect is true for a shallower than planned dive angle, but the resultant short error is greater than a long error resulting from a steep dive angle. The most important fundamentals are to be at the correct roll-in point and set the correct AOD which equates to proper dive angle. These are the greatest errors, and once set, all other errors become correctable.

#### 5.7.8.2. Release Altitude

This results in two partially canceling errors. The first is release-point range error in that the aircraft is further forward in space if release altitude is low with the pipper on the target. This gives a long impact. The other error is a bomb trajectory error. If release altitude is low, bomb trajectory is reduced, but still the bomb will hit long as this is the lesser of the two errors. Again, it must be assumed that the pipper is on the aimpoint and the other parameters of the release are met (Figure 5.15). It's simply a result of not holding AOD.

#### 5.7.8.3. Airspeed Error

Fast or slow release airspeed can result from such mistakes as the wrong power setting, incorrect airspeed on the base leg, improper roll in, and error in dive angle. The two factors that result from airspeed deviations are bomb trajectory change and change of AOA. The resultant impact error is cumulative. Higher than planned airspeed results in a flatter bomb trajectory and a long hit. Increased

airspeed decreases AOA which increases effective depression, giving a late sight picture and a long hit (Figure 5.13).

#### 5.7.8.4. **Release G Error**

Each delivery has a preplanned G-loading at release. This G is a function of the cosine of the dive angle. It is not a factor we read on a gauge in the cockpit during release, but a "seat-of-the-pants" thing. To release a bomb with other than the preplanned G on the aircraft changes aircraft AOA, thus changing effective depression. In a normal approach, the piper is moved to the target at a rate so it reaches the aimpoint as other release conditions are attained. If the sight picture is attained too early and the piper is held on the aimpoint, you will begin to decrease release G, decrease AOA, increase effective depression and get a long hit. Also, if you hold the bunt long enough, you may change your dive angle and this will add to the long impact. More G than planned, i.e., pulling the piper up the aimpoint, results in a short hit (Figure 5.14).

#### 5.7.8.5. **Bank Angle**

A fairly common error in bombing deliveries is releasing with a wing low. A slight bank is difficult to recognize when the horizon is 30° or more above the flight path. But, if the aircraft is banked at release, the sight picture is erroneous. This is due to the pendulum effect of the depressed sight. As the aircraft is banked, the sight swings in the opposite direction. With the piper on the target under these conditions, the bomb will hit short and in the direction of the bank because the aircraft's flight path is not towards the target and the slant range to target is increased (Figure 5.16).

#### 5.7.8.6. **Skid**

Release during uncoordinated flight causes an erroneous sight picture. In any bomb delivery, the bomb follows the flight path when released. If the ball is out to the right, the bomb will impact to the right. A last-ditch rudder correction to obtain the proper sight picture is not going to bring the bomb over to the target. The sight line and ground track must be parallel for the bomb to hit where the piper is placed. The bomb will go long, in the direction of the skid.

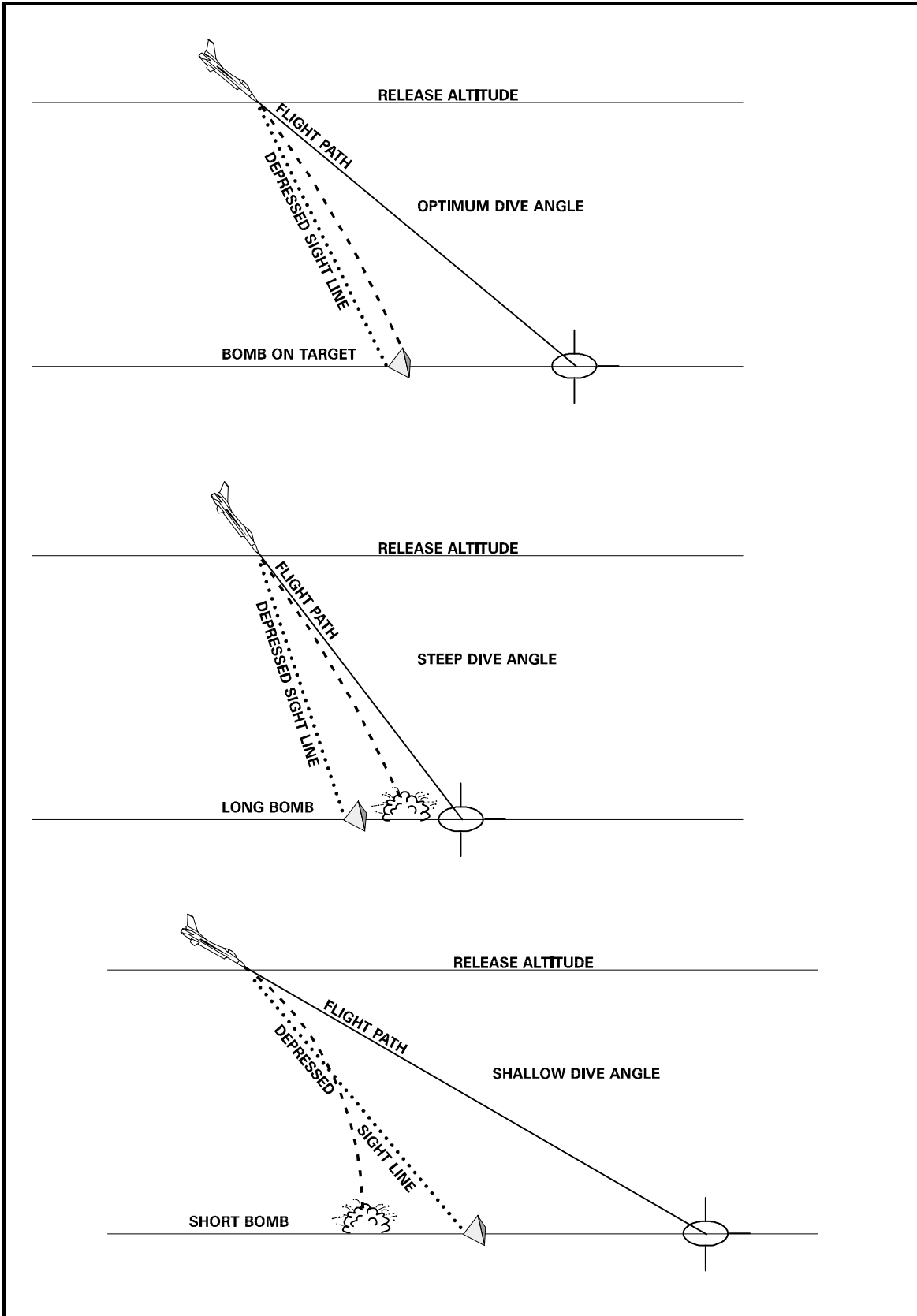


Figure 5.12 Effect of Dive Angle on Bomb Impact

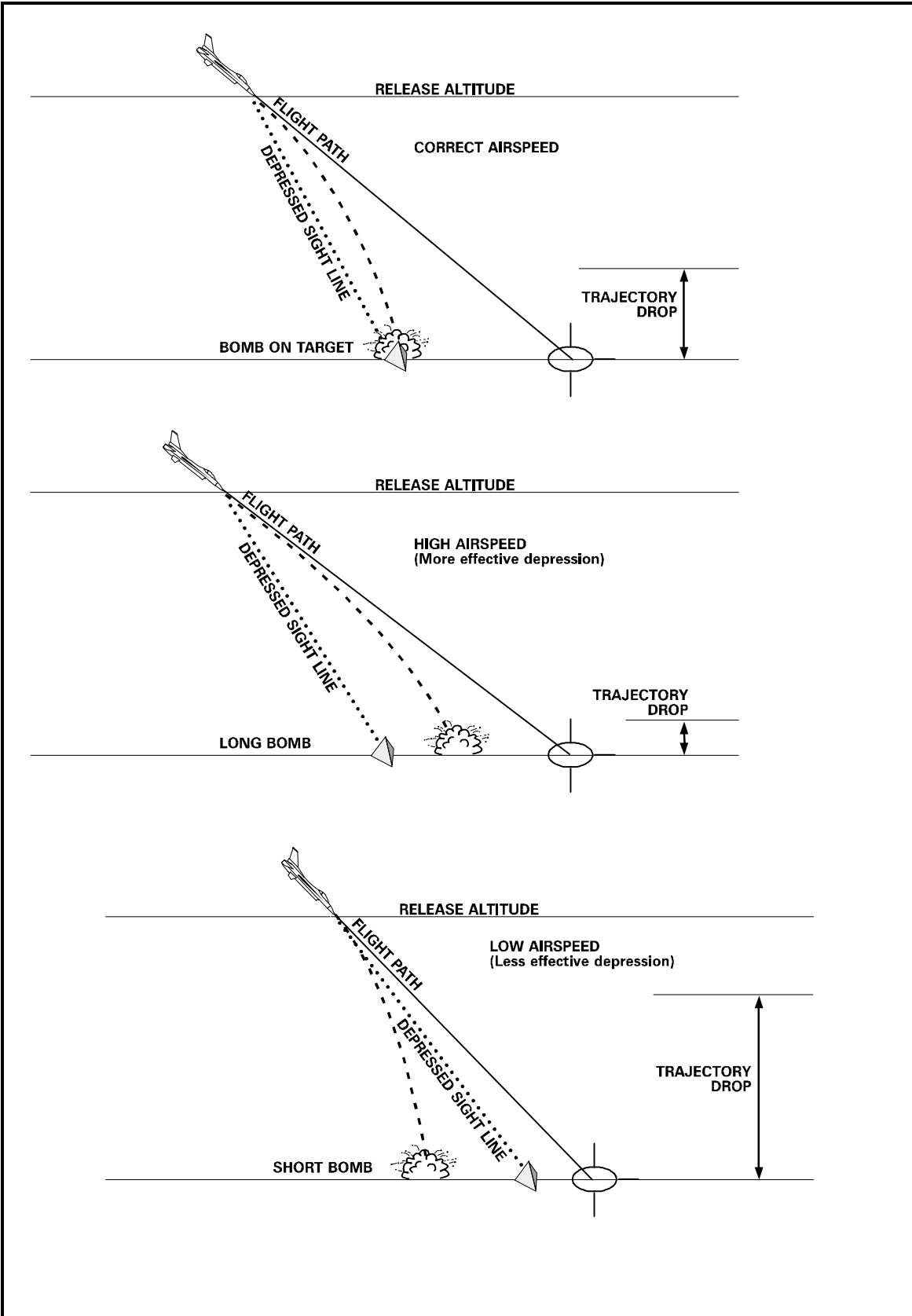


Figure 5.13 Effect of Airspeed on Bomb Impact

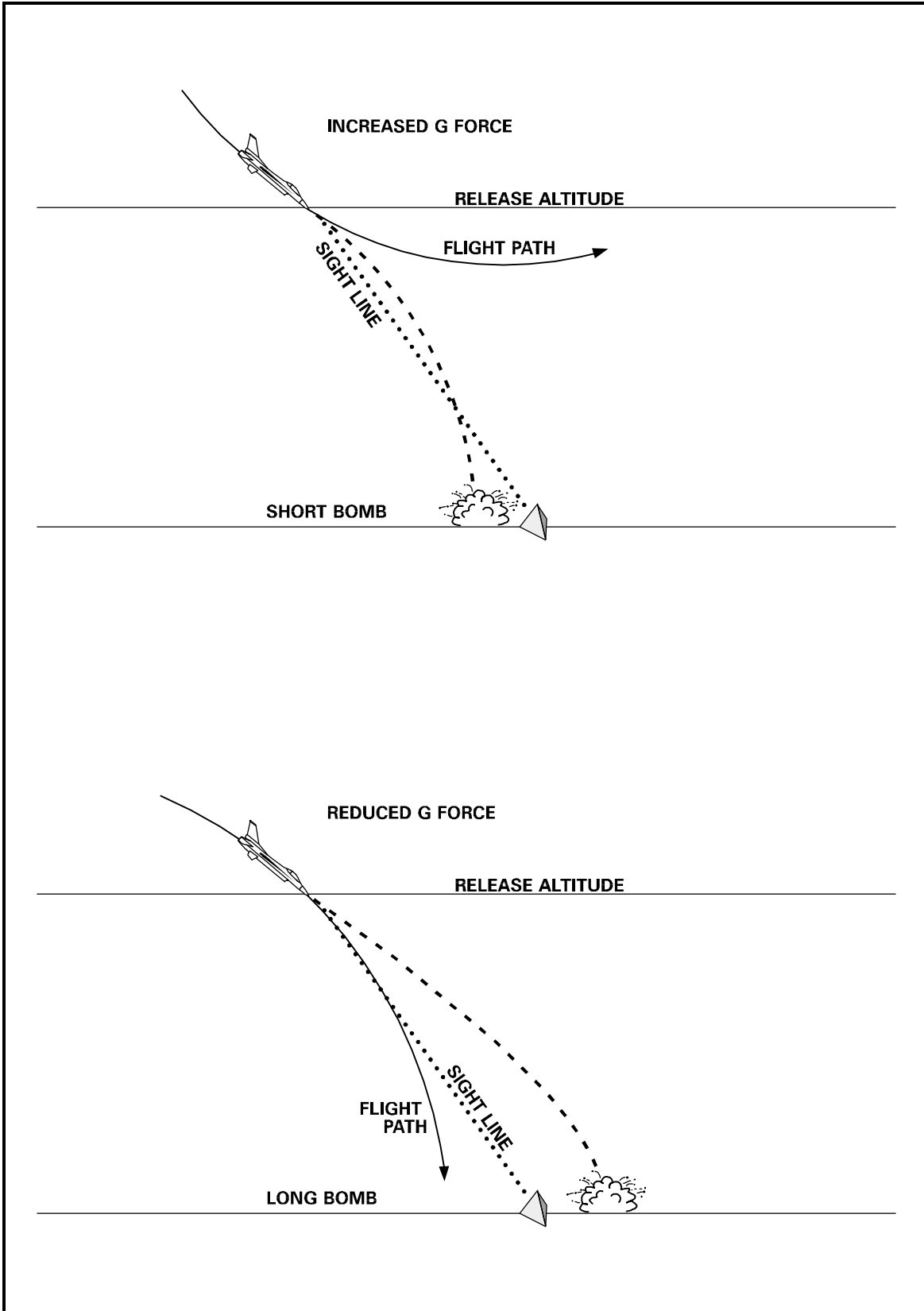


Figure 5.14 Effect of Improper G Force on Bomb Impact



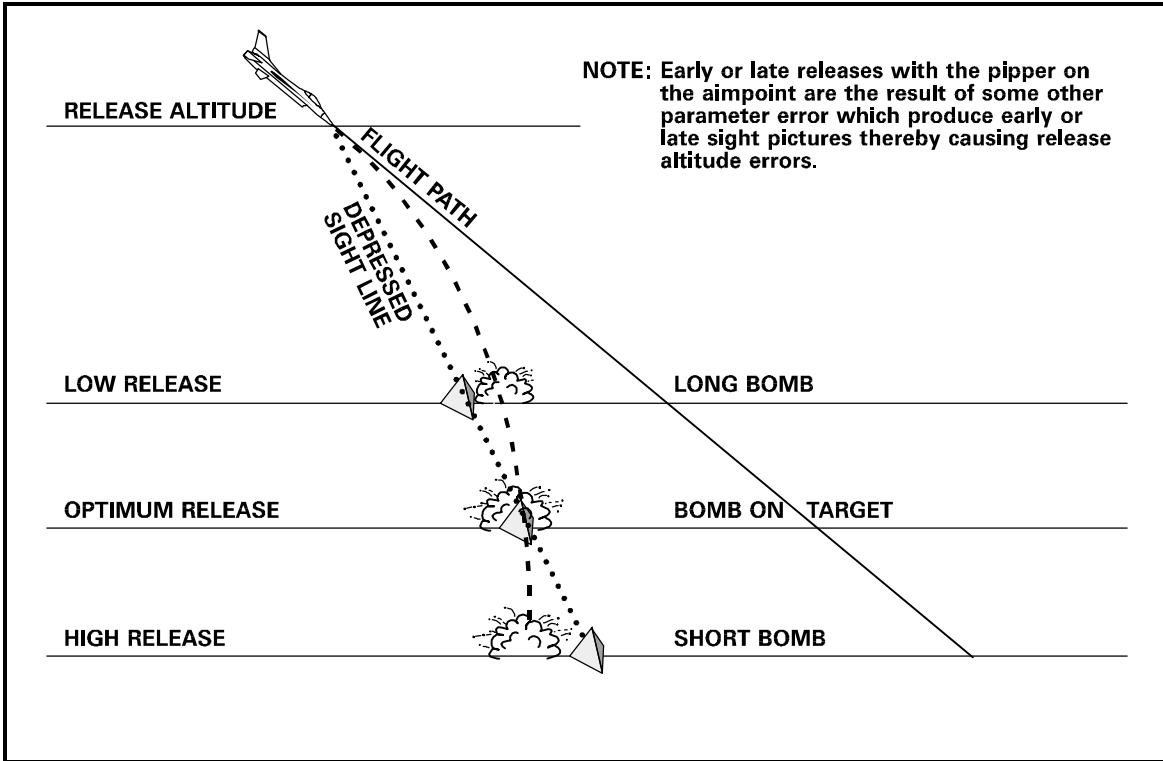


Figure 5.15 Effect of Release Altitude on Bomb Impact

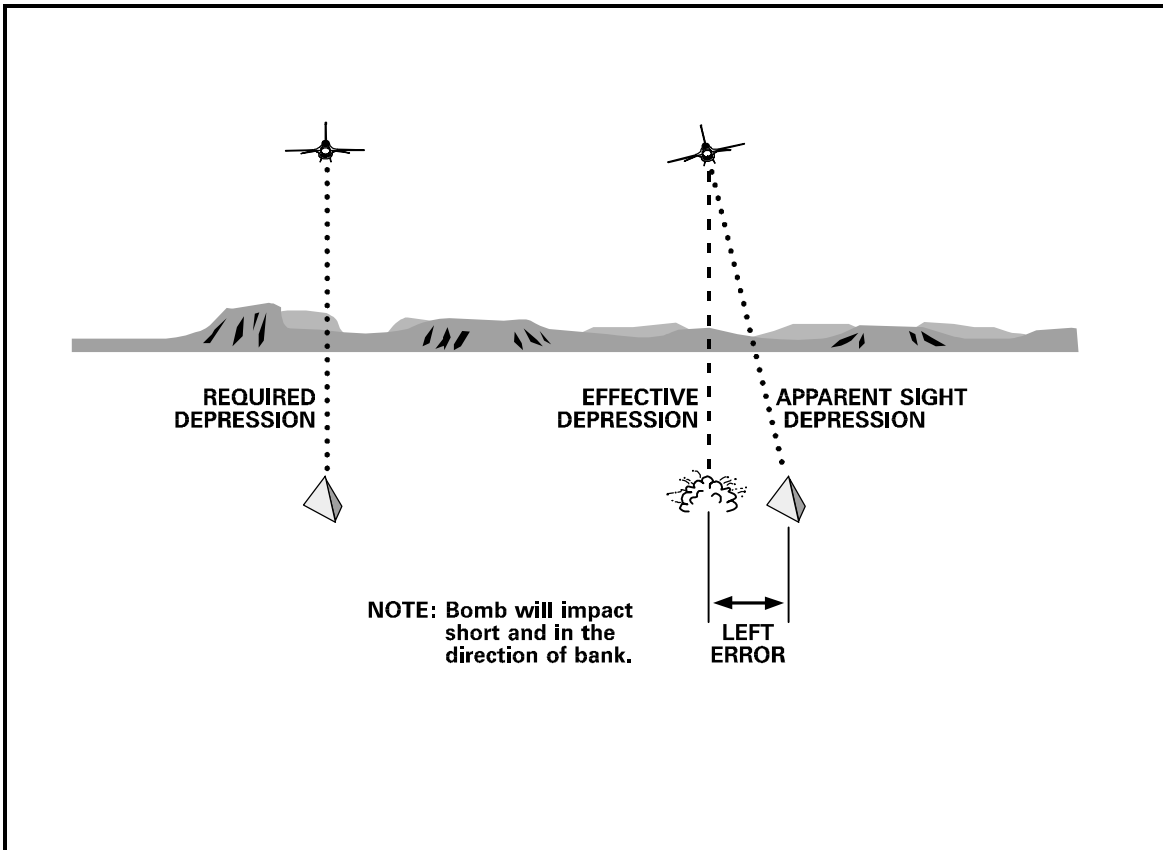


Figure 5.16 Effect of Bank Error on Bomb Impact

## 5.8. Tactical Considerations

### 5.8.1. Visual Level Delivery (VLD)

This delivery profile is essentially a level delivery or very shallow dive similar to that used for high drag weapons. However, parameters for adequate fuze arming and safe escape become much more critical due to the weapon time of flight. F-16 ballistics tables have minimum release parameters for various fuze settings. CCIP is the recommended delivery mode.

Advantages:

- Exposure time is minimal.
- Navigation is direct to the target. No offset is required.
- Reduces acquisition time for threat systems.

Disadvantages:

- Target acquisition is difficult.
- Low impact angle may reduce weapons effectiveness.
- The minimum altitude for fuze arming and frag clearance is easy to violate.

### 5.8.2. Dive Bomb (DB)

Dive bomb is a delivery from medium altitude using 20° or steeper dive. Roll-in altitude is achieved through a pop-up, combat climb, or medium-altitude ingress.

Advantages:

- Increased bomb impact angle with improved penetration effectiveness over low angle deliveries.
- Increased accuracy due to slower movement of the piper across the ground and increased radar graze angle. Baro bombing system altitude errors have less effect.
- Increased time for target acquisition.
- Radar-fuzed CBU weapons may be delivered effectively.
- Recoveries may be accomplished above some small AAA threats.

Disadvantage:

- Exposure to the SAM and air-to-air threat increases significantly.

### 5.8.3. High Altitude Release Bomb (HARB) and High Altitude Dive Bomb (HADB)

HARB and HADB are deliveries from medium or high altitude preferably using 30° or steeper dive. Roll-in altitude is typically achieved from a high altitude ingress. Problems associated with HARB and HADB include high crosswinds, lateral miss bomb release inhibit (if using CCRP), delay cues, and high G releases due to delay cues. In addition, weapons effects may vary greatly from those expected at lower release altitudes. Increased slant ranges, longer radar ranging, and high transonic release airspeeds all result in unpredictable bomb separation effects, cluster munition patterns and unpredictable weapon impact points. Above 15,000 feet AGL, GPS equipped aircraft with a high navigation system status and accurate target coordinates, should consider dropping in CCRP in order to minimize visual aiming errors. When dropping GP bombs, release intervals should be at the minimum, due to increase bomb time of fall, long release intervals, and separation effects. For cluster bombs, use the lowest HOB compatible with the ordnance and desired weapons effects to minimize dispersion of submunitions due to wind effects.

Advantages:

- Increased bomb impact angle and penetration.
- Increased time for target acquisition.
- Recoveries may be accomplished above small arms/light AAA threats.

Disadvantages:

- Increased exposure to SAM and air-to-air threats.
- Unpredictable weapons effects.

- Decreased accuracy with free fall munitions; especially CBU.
- Difficult to maintain visual mutual support during recovery and egress due to large altitude changes.

#### 5.8.4. Low Altitude Toss (LAT)

This profile allows accurate visual deliveries of low drag munitions at standoff ranges.

Advantages:

- Provides lateral spacing for frag deconfliction.
- Allows standoff from several lethal defensive systems.
- Increased defensive maneuvering time against SAMs in the target area.
- Increased availability of tracking time.
- Allows considerable flexibility in meeting planned parameters.
- Eliminates problems associated with being inside the MAP/PUP.

Disadvantages:

- Accuracy is degraded over a CCIP delivery.
- Long slant ranges can cause difficulties with target acquisition.
- Increased exposure time but at longer slant ranges.

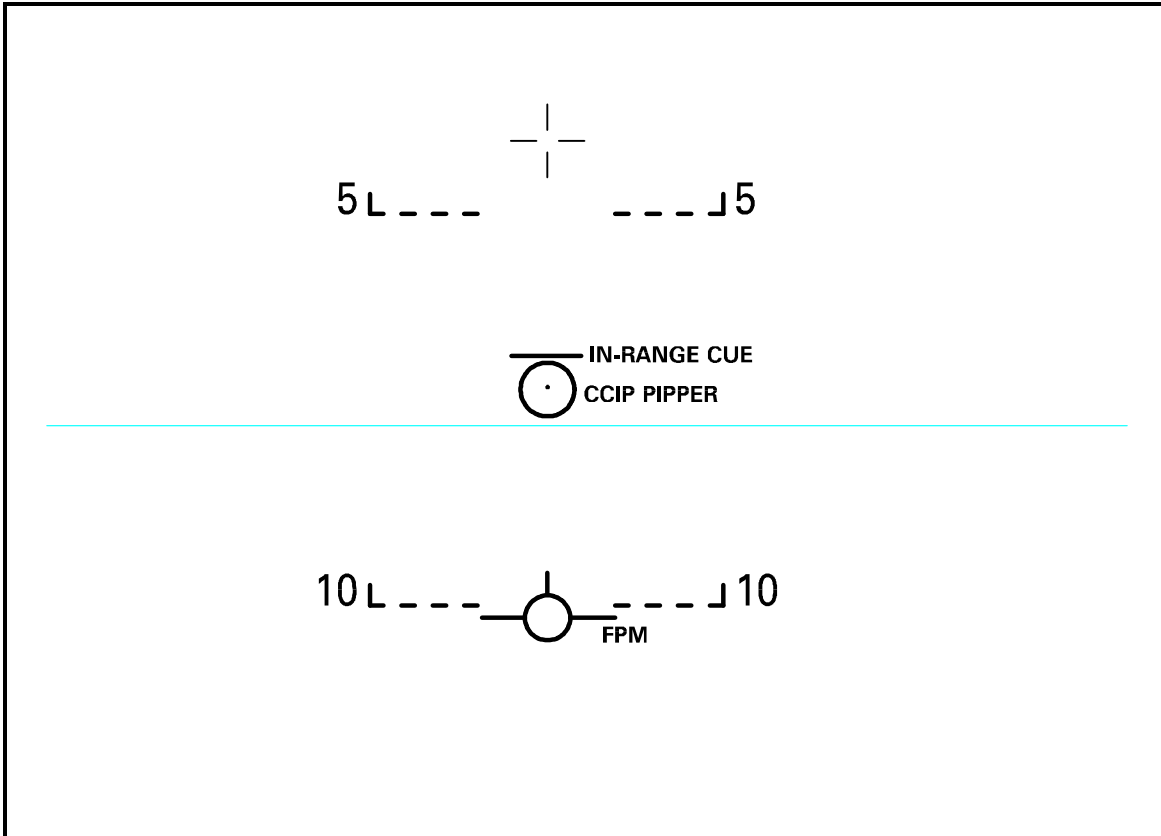
### 5.9. Strafe

Since the computer merely presents a continuous prediction of bullet impact in the HUD, the fundamental techniques of manual strafe must still be applied. The primary advantages of computed strafe over manual strafe are the automatic calculation of an upwind aimpoint and the freedom to fire at any range within the effective gun envelope. These features permit reliable impacts even in high or changing crosswinds. The CCIP pipper is originally depressed for the slant range at which you roll out on final. When arriving at 4000' (approximately 6000' for PGU-28) slant range, an in-range cue ("the hat") will appear (Figure 5.17). As range decreases, the CCIP pipper will rise vertically, reflecting a reduced gun elevation requirement. The information in this chapter does not reflect effects of the new PGU-28 bullet that is about to be fielded.

#### 5.9.1. Effects of Wind

When crosswinds are present, the FPM is shifted downwind (Figure 5.18). Yet the gun is still boresighted along the gun cross. Bullet impact will be someplace between the two, proportional to drift angle and slant range. Consequently, the aiming symbol will be upwind of the FPM. As range decreases, the CCIP pipper will move laterally toward the gun cross. The combination of the above two characteristics results in CCIP pipper motion as range decreases from the original position always toward the gun cross. Bank and/or yaw can distort this classic geometry slightly when maneuvering toward the target, but should not be a factor when approaching open-fire ranges.

Crosswind effect during firing can best be controlled by using small amounts of bank to control lateral pipper drift during the approach. This should result in having the proper amount of bank on the aircraft at open-fire range. You then maintain this bank while firing which should keep the pipper from moving off the target downwind. Effect on bullet impact due to firing in a bank is minimal. A rule of thumb is that one knot of crosswind will require slightly less than 1° of bank to counteract. Compensating for a crosswind is subtly different in strafing. In bombing, the objective is to crab or drift so that the bomb ground track passes through the target. Because of the self-possessioned velocity of the bullets, the bullet track will not be at all the same as the ground track of a crabbed or drifting aircraft. Consequently, in strafe we are primarily concerned with aiming the gun, not the aircraft velocity vector, toward the target.



**Figure 5.17 Computed Strafe Symbology**

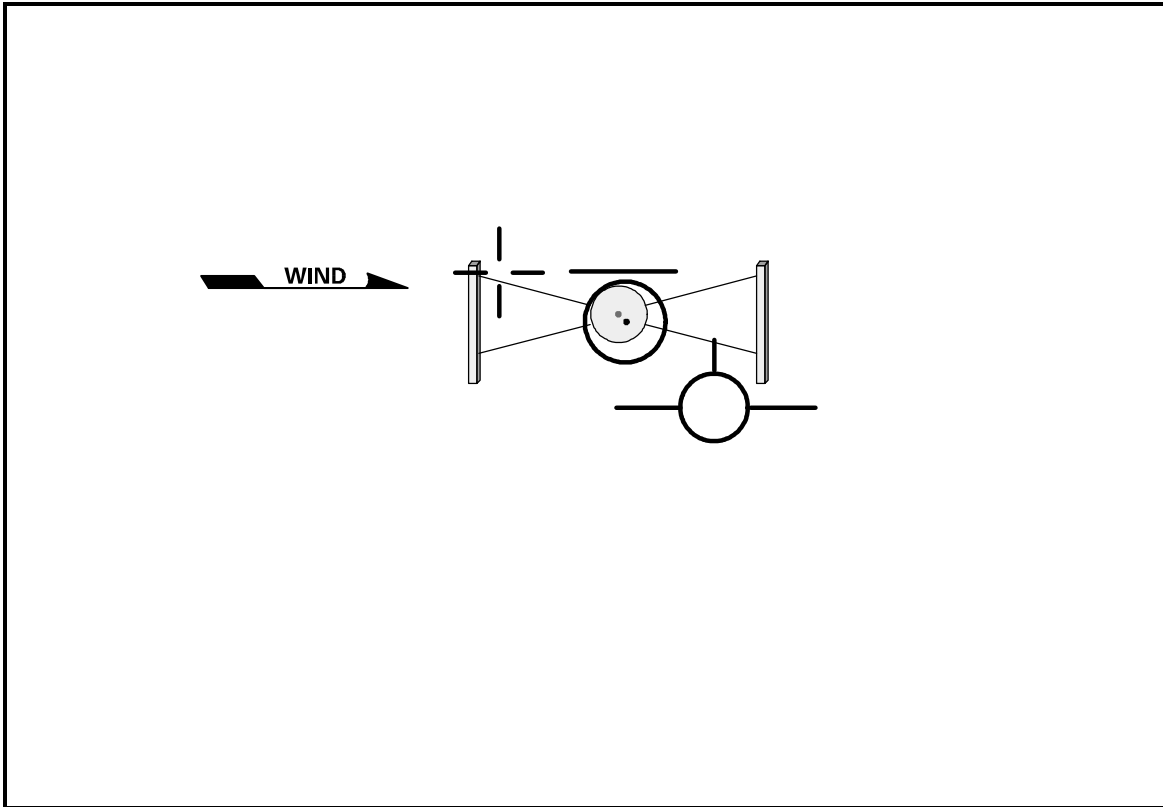
### 5.9.2. Low-Angle Computed Strafe

On downwind Select gun mode and strafe option on the SMS. Check master arm to MASTER ARM and ARM in HUD (local restrictions permitting). Verify air-to-surface gun symbology and declutter the HUD as necessary.

Fly the base leg and roll in as described for low angle bomb. One technique is to roll out with the bottom of the gun cross on the target.

Lead the roll in to final in order to line up on the run-in line (if applicable) of your target. Normally, on a controlled range, there will be at least two active panels which are scored acoustically (acousti-score). Due to the nature of acousti-score, bullets that pass over the microphone high or are subsonic, will not register as hits. A common technique is to strafe alternate panels, i.e. if number chooses panel one, then number two strafes panel two, number three strafes panel one, etc. This allows time for dust to clear on that panel from a previous pass. The following steps are a technique used by many Viper pilots to achieve maximum strafe hits:

- Roll out with the gun cross initially on the rag. Check dive angle at 10°–15°.
- Note the pipper relationship to the run-in line to determine crosswind.
- Offset gun cross into the wind and note pipper tracking up the run-in line.
- Set power to maintain 420-450 KCAS maximum.
- As the “hat” comes on, **ease** the pipper to the bottom of the rag.
- As the 2,000’ foul line passes under nose, **Track**.
- **Shoot**.
- **Track**.
- Recover.



**Figure 5.18 CCIP Strafe with Crosswinds**

Regardless of the tracking method you use, it is still a good idea to fire a short sighter burst on the first hot pass. Note the CCIP pipper position when you fire. If the impacts were not through the CCIP pipper, use an adjusted aimpoint on subsequent passes. Remember, on each pass you are wasting ammo if you fire when your CCIP pipper is off the aimpoint. Remember, **Track Shoot Track**.

### 5.9.3. High Angle Computed Strafe

This delivery is used tactically much more frequently than low-angle strafe to avoid small arms fire and allow bullet penetration into revetted or entrenched positions. Open-fire slant range is slightly more than two times that of low-angle strafe (6200'). Consequently, computed impact prediction greatly improves results in an environment of unknown winds and extreme slant range.

Perform the roll in from 8000' AGL as you would for a 30° dive with point-blank aiming. The FPM should initially be short of the target with the CCIP pipper some 50 plus mils below it. This roll in is significantly more nose low than it is for DB because your AOD is actually a negative value (short of the target). Using the gun cross as an initial aiming reference will help until the FPM and CCIP pipper become stabilized.

Note your altitude and set power for release airspeed at open-fire range (normally idle). Monitor your descent rate toward open-fire altitude. Control the rate of CCIP pipper movement toward the target with back stick and bank so as to have it there as you arrive at 4000'–3500' open-fire altitude. Since the in-range cue does not appear until 4000' (6000' for PGU-28) slant range, it may not be above the CCIP pipper at open-fire altitude.

### 5.9.4. Manual Low-Angle Strafe

Compared to bombing, strafe attacks are relatively simple. You need only point the aircraft at the target, correct for gravity drop and small amount of wind correction, and fire away.

On downwind, check sight depression mil setting and adjust manual reticle intensity low enough to allow you to see and focus on the target.

Fly base and roll-in similar to low angle bomb pattern. Before you roll in, look at the target and pinpoint the general location of the open-fire range. On the controlled ranges, this would be approximately 150% of the distance from the foul line to the target.

During roll-in, keep your eyes primarily on the target/aimpoint with an occasional cross-check of airspeed. As the target comes into the HUD FOV, play the roll out so that the pipper is initially short and slightly upwind of the target/ aimpoint. In practice, it's advisable to plan your final turn to roll out with the pipper slightly upwind (laterally) of the target/aimpoint. A crosswind component will require the gun to be pointed upwind 1.5 ft/kt at 2400' open-fire range, decreasing to 1 ft/kt at 2000'.

After roll out and initial pipper placement, check airspeed and adjust power. Recheck and readjust as required. Airspeed has little effect on bullet impact, but it does affect aircraft control. As you close toward the target, focus your eyes on the chosen aimpoint and monitor pipper movement with your peripheral vision. The pipper should be moving smoothly towards the aimpoint:

- Continuously estimate your closure rate toward the open-fire range.
- Use bank to adjust lateral pipper movement.
- Longitudinal (six/twelve o'clock) drift rates are critical and more difficult to correct.

You want to open fire with the pipper on the aimpoint when you are approximately 2400' from the target. Open fire range is more critical in manual strafe, as bullet drop increases dramatically as firing range increases. During the firing of the gun, the pipper must be on the aimpoint. About 2 seconds of tracking is the maximum you'll be able to achieve. Therefore, do not concentrate tracking the pipper on the aimpoint before open-fire range. Fire the gun using just enough forward stick pressure so the pipper "pauses" on the target between open fire and cease fire. On the first strafe pass you may want to fire only a "sighter burst." The purpose is to verify gun/pipper boresight and validate your crosswind computation.

Cease fire as you approach the foul line and initiate a recovery. Do not wait to see your bullets impact. You'll soon receive your score from the range officer.

#### 5.9.5. Manual High-Angle Strafe

This delivery is difficult in that release parameters are near the outer limits of effective 20 mm gun range. In a 30° attack, a typical open fire slant range is 6000' which requires considerable gun elevation to counter the increase in gravity drop. Since the path of the bullets is no longer flat, open-fire slant range becomes more critical. As you reach 1000' above open-fire altitude, move the pipper up to the aimpoint. Track, fire, and track until the burst is completed. Execute the recovery immediately after the gun stops firing. Do not delay to watch bullet impact. Due to the increased range and corresponding increased time of flight of the bullets, if you see the impact, you may never see anything else, other than your own impact.

#### 5.10. Tape Assessment And Foot Print Data

An intelligent 781 write up goes a long way, but frequently, impact errors are caused by bad boresight, a problem that cannot be corrected overnight.

Your squadron should have foot print data for all its aircraft. The validity of data is based on you properly assessing your performance on each pass and comparing aimpoints to impacts. The program is only as good as your inputs, so assess your VTR and fill your bomb sheet with the required information. Before you fly, look at the foot print data. Don't aim 50' short just because the last pilot wrote that your aircraft had dropped 50' long. See how recent the last flight was and look at the last pilot's experience level.

#### 5.11. Nonvisual Bombing

This section covers delivery modes (CCRP, LADD, and BCN) you can use to accurately attack targets without visually seeing them. Most of the time, this will culminate with a loft attack. The most obvious use of this nonvisual capability is in weather or at night. But, there are day VMC tactical situations where you will accurately know the target location prior to arriving in the target area and can reduce your own exposure by using a nonvisual mode. The situation that comes to mind is the nonconventional one but you can also accurately loft conventional ordnance as well, without actually seeing the target. You can

also use nonvisual techniques to help find the target and then convert to a pure visual attack (CCIP or DTOS). You can navigate to a target and bomb it solely using the INS, but without GPS, accuracy will be limited by planning errors and/or INS drift. Accuracy can be improved by updating the FCC data with radar or HUD cursor slew commands and/or overfly-designate updates to FCC steering. INS updates may also improve delivery accuracy. Even when the target area can be seen, using the TD box in conjunction with visual search lessens the possibility of confusion being introduced by passive CCD techniques. For example, the TD box may designate a target that has been toned down with nets or paint, leaving an intentionally developed false target nearby to draw the attention of the attacker. An effective practice could be to closely examine the TD box designated point for deceptive measures before committing to the visually attractive DMPI. Figure 5.19 illustrates the HUD symbols.

5.11.1. Loft Tactical Considerations

The loft delivery is usable for area targets when using area weapons or when standoff is required against short-range defenses. Accurate coordinates and system accuracy (INS, FCC, system altitude) are paramount to ensure desired weapon effects. Azimuth steering and the initial pull-up are the most critical factors in this maneuver. The FCC will still attempt to deliver the munition to the correct point over the target, but the variations become important with radar-fuzed munitions and special weapons.

Advantages:

- Weapon delivery takes place at standoff ranges of 2 to 5 miles from the target.
- Radar-fuzed CBU munitions can be delivered from low run-in altitude.

Disadvantages:

- The jet is exposed belly-up to the target area and the loft maneuver may place the aircraft in SAM engagement zones.
- Accuracy is decreased with INS navigation errors (especially non-GPS aircraft).
- Long weapon time of flight combined with wind effects results in decreased accuracy.
- Accurate target and aiming offset coordinates must be available.

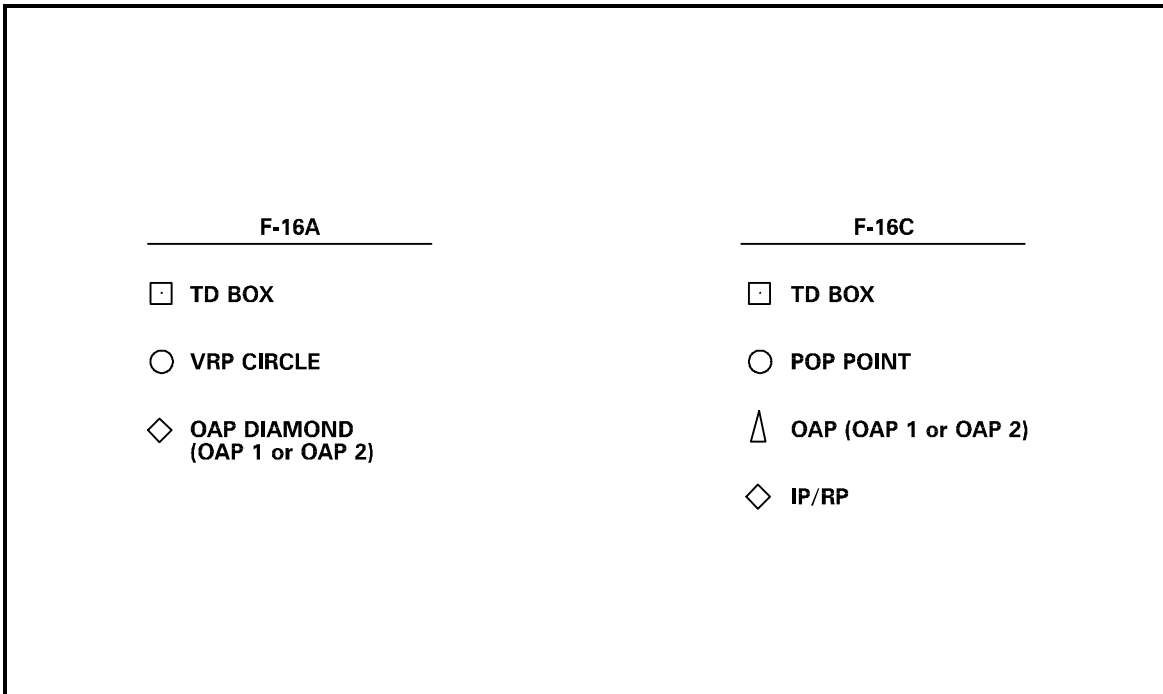


Figure 5.19 HUD Symbology

NOTE: For simplicity, the remainder of this discussion is divided into two sections. Section A will cover the F-16C and Section B will cover the F-16A.

**Section A—F-16C.****5.11.2. Critical Avionics**

The APG-68 radar, FCC, GPS (if equipped), and other F-16C system integration areas combine to make up the primary components to accurately employ ordnance on a non-visual target. The FCC uses INS information to position HUD and radar symbology on the selected reference. The cursor rotary is used to select the sighting option. The pilot can update his symbology by inputting FCC slew commands or by designating the VRP point to the FCC at overflight. The sensor of interest (SOI) identifies the radar or the HUD as the primary sighting reference. To use the designate option the **SOI must be in the HUD**. Overall system accuracy is a function of input data, INS drift, NAV status, and any updates made by the pilot.

**5.11.3. APG-68 Radar**

The FCC places the cursors on the radar at the INS estimated position of the steerpoint, OAP, or IP/RP. Refinements can be made using the cursor on the throttle. For more detail, depress the FOV (pinky switch). This places the cursor in the center of the display and expands the detail by a factor of four. In 10, 20, and 40 NM scopes depressing the pinky switch again commands the DBS-1 mode, which increases azimuth resolution for returns more than 5° off the nose. Depressing the pinky switch again commands DBS-2 which increases display resolution by 64:1 and is optimized for returns more than 15° off the nose.

*CAUTION:* In expand, DBS-1 and DBS-2, the cursors stay centered on the display which can cause misorientation. Use the SA cue (+) and HUD to remain oriented in the delivery. The SA cue indicates the position of the cursors on expanded displays.

**5.11.3.1. Receiver Gain**

Each GM FOV has an individually adjustable gain. The manual range/uncage knob can control 35% of the gain selected on the radar. For an initial setting, select normal FOV and rotate the uncage knob full clockwise (maximum) then adjust the gain with the rocker switch to approximately 40%–45% on this gain scale. Then select expand and adjust gain so that with the hands-on control, a nearly black picture can be achieved with minimum gain. DBS-1 and -2 gain will automatically initiate at approximately 90%. Little adjustment is necessary.

**5.11.3.2. El Strobe**

Antenna elevation, or tilt, is controlled by the FCC in GM to keep the radar pointed at the steerpoint or offset. But you can override the FCC by moving the antenna elevation thumbwheel out of the detent. If you do, the FCC will still automatically adjust tilt but it will be biased by the elevation knob position.

**5.11.3.3. Range**

To get the best resolution, you should use the smallest range scale that will allow you to see the cursors. Keep the cursor intersection in the top half of the display.

**5.11.4. FCC Data**

Accurate steering is obviously driven by the accuracy of the data you enter. The VRP data must identify the correct steerpoint as target data and VRP bearing and range data must be correct, and both points must have accurate elevations entered. Elevations are important since this data is used for positioning radar and HUD symbology. Additionally, anytime you bomb with the FCR in a non-AGR mode, the FCC uses steerpoint elevations for BARO bomb computations.

**5.11.5. F-16C System Integration**

When you select CCRP or LADD delivery mode on the SMS, the IP or TGT steerpoint must be selected on the data entry display (DED) and VRP/VIP must have been previously mode selected for the VRP/VIP sighting options to function. Only one mode, VRP or VIP, can be selected at a time. With these requirements met, the radar cursors automatically go to the target, OAP, or IP/RP, (depending on what you've selected on the radar). The HUD symbology, TD box, OAP triangle (if OAP selected), and the IP/RP diamond appear if these points are in the HUD FOV. If the steerpoint is not in the HUD, you will



see the target locator line. If you discover an aiming error, you can slew the cursors or HUD symbology over the point of interest. Slew rates are optimized for whichever point you have selected on the radar (TGT, OAP, IP/RP). All cursor slews carry over for other steerpoints and deliveries. Cursor zero (CZ) can be used to clear all slews and place the cursor at the INS estimated point. The sensor of interest automatically initializes to HUD when the VRP/VIP aiming option is mode-selected. The bearing pointer and DME on the HSI usually points to the INS estimate of the steerpoint. The exception being post designate VIP, then it points to the designated IP.

#### 5.11.6. VIP/VRPCR

Switches:

- Master mode—AG.
- Steerpoint selected—TGT (IP for VIP mode).
- FCR mode—GM, SEA, BCN, GMT.
- SMS—weapon, profile, RP, pair/SGL, CCRP.
- Master arm—MASTER ARM or SIMULATE.
- Sight point option—select TGT/OA/IP/RP.
- VIP/VRP—mode select on DED/set proper steerpoint as IP/target.

Considerations:

- Ranging is BARO since AGR is unavailable. Check system altitude and do an ACAL if required.
- Select the scope range which shows the steerpoint in NORM FOV.
- Check the antenna elevation knob in the detent. The FCC will automatically control tilt.
- Work big to small. Select the best radar return—TGT/OA1/OA2/IP/RP. Adjust radar gain if required using hands on control.
- Once the proper return has been positively identified, expand, DBS-1, and DBS-2 may be used to refine cursor placement.
- If an overfly update is desired, with the SOI in the HUD, depressing designate will update the weapons aiming solution and the SOI will return to the radar. Further refinements can be made on the radar if required.
- Fixed target track (FTT) can be used to track a return. Pressing designate with the SOI in the radar and the radar in any GM FOV commands FTT if the radar can track the FTT point.
- Fly the FPM to the steering line or center the steering symbol on the radar or SMS. Time to release is available in the HUD.
- Two seconds prior to maximum range for weapon delivery, a 100 milliradian circle appears in the HUD to warn of the maximum solution. At maximum solution range, the circle flashes for 2 seconds, then disappears and the solution cue appears on the bomb fall line.
- CCRP allows you a choice of delivery G and pitch. You can pull up and loft the ordnance, continue in level flight, or dive at the target if required.
- When the solution cue reaches the FPM, the bombs will release and the FPM will FLASH.
- The SMS weapons quantity will not count down until the pickle button is released. If the weapon quantity decreases to zero, the HUD A-G symbology will disappear.

#### 5.11.7. VIP/VRPLAD

Switches:

- Master mode—AG.
- Steerpoint selected—TGT (IP for VIP mode).
- FCR mode—GM, SEA, BCN, GMT.
- SMS—weapon, profile, RP, pair/SGL, LADD.

- SMS control page—pull-up range, verify.
- Master arm—ARM/SIMULATE.
- Sighting point—TGT/OA1/OA2/IP/RP.
- VIP/VRP sighting option—mode select on DED, set proper steerpoint as IP/target.

Considerations:

- Radar operation, consideration, and procedures are the same as those for VIP/VRPCRP.
- Ten seconds prior to the pull-up, the vertical steering cue appears and moves toward the FPM.
- When the cue hits the FPM the solution cue resets to the top of the HUD and this vertical steering cue commands a pull to 45°.

#### 5.11.8. Beacon Bomb Delivery

The BCN radar mode is used to attack targets that are located relative to a ground-based radar beacon. This mode is similar to the radar offset mode. Target location is based on bearing and range from the beacon to the target and target elevation.

- Enter the following offset data before takeoff on the appropriate destination page:
  - True bearing from beacon to target to the nearest 0.1°.
  - Range from beacon to target in feet.
  - Elevation of the target.
  - Appropriate beacon delay on the FCR control page.
- FCR mode must be in BCN. The radar provides a clutter-free display on the radar display showing only the radar beacon location and eliminating target/aimpoint recognition tasks.
- Select A-G with the desired weapon and BCN mode selected.
- Slew the azimuth cursor to the center of the closest portion of the beacon.
- Center the FPM on the steering line and continue the delivery in the same manner as in a CCRP attack.

### Section B—F-16A.

#### 5.11.9. Critical Avionics

The FCC uses INS information to position HUD and radar symbology on the selected reference. In direct aim (DIR) this is the selected thumbwheel destination. In OAP 1/2 it is the selected offset aimpoint. The pilot can update his symbology by inputting FCC slew commands or by designating the VRP point to the FCC at overflight. Overall system accuracy is a function of your data, INS drift, and any system updates made by the pilot.

#### 5.11.10. APG-66 Radar

You use the radar to locate a known point on the ground (either the steerpoint itself or an OAP from it). Several radar modes are designed for surface target acquisition (GM, BCN, SEA 1 and SEA 2). From a pilot's perspective, they are functionally similar in that they put surface returns on the radar display to track with the radar cursors. GM is the most often used mode for radar navigation and fixtaking. When you enter this mode, the FCC will put the cursors on the radar display where the INS thinks the steerpoint or OAP target is located. You can then make refinements using the cursor control button on the throttle. If you want more detail, move the designate/return to search switch aft to RTN TO SRCH. This will move the cursor intersection to the center of the scope and expand the detail by a factor of four. In 10 and 20 mile scopes, a second RTN TO SRCH will put the radar in doppler beam sharpening (DBS) mode, a mode that increases azimuth resolution for returns more than 15° off your course. Beware! In expand and DBS, the cursors stay centered; it's very easy to misinterpret the display and think you're headed directly at the steerpoint.

#### 5.11.10.1. Receiver Gain

You have control over the receiver gain in ground map modes. This allows you to adjust the radar display so you can see various amounts of detail. For example, you may have planned to use the edge of a town on the shore of a lake as an OAP. You could have the radar gain turned up to find the lake and the general area of the town, and down so you can accurately place the cursor over the edge of the town's return. You can use the gain knob on the radar display to control the gain from 0% to 100% of its range and use the manual range/uncage knob on the throttle to control the gain  $\pm 35\%$  of the radar display setting. To initially set the gain, rotate the gain control full down and then back about half way. Using the manual range/uncage knob you should be able to adjust the gain almost back to the full bright position. Readjust the receiver gain knob if necessary to ensure proper "hands-on" control.

#### 5.11.10.2. EI Strobe

Antenna elevation, or tilt, is controlled by the FCC in GM to keep the radar pointed at the steerpoint or offset. You can override the FCC by moving the antenna elevation thumbwheel out of the detent. If you do, the FCC will still automatically adjust tilt, but it will be biased by the elevation knob position.

#### 5.11.10.3. Range

To get the best resolution, you should use the smallest range scale that will allow you to see the cursors. Keep the cursor intersection in the top half of the display.

#### 5.11.11. FCC Data

Accurate steering obviously depends on the accuracy of the data you put in the FCNP. Not only does the steerpoint latitude/longitude need to be correct, but so does the steerpoint elevation. This is for two reasons. First, the FCC uses the elevation to point the radar antenna and HUD symbology. Second, when you bomb while the radar is in a blind bombing mode (CCRP, LADD, or BCN) the FCC uses steerpoint elevation from the FCNP to compute ballistics. If the elevation's wrong, the FCC solution will be inaccurate. In the F-16A, you can also load two OAPs for each thumbwheel destination. One VRP and one VIP may also be entered. You enter a true bearing and range from the steerpoint to the OAP or VRP. In VIP, information is from the IP to TGT; in VRP, information is from target to RP. Be careful: if you reverse the bearing your cursors will be wrong. Also, it's possible to enter a negative number for the range. Again, the cursors will then be in error.

#### 5.11.12. F-16A System Integration

When you select CCRP, BCN, or LADD delivery mode the selected thumbwheel destination is automatically designated as the target. The radar cursors automatically go to the target or an OAP (depending on whether you've selected DIR AIM, OAP 1, or OAP 2) and begin automatically tracking that point. HUD symbology, an OAP diamond if in OAP 1 or OAP 2, and a VRP circle, will join the air-to-surface TD box if these points are in the HUD FOV. If the steerpoint is not within the HUD FOV, you will see a target locator line. Initially, these points will be where the INS thinks they are. Without any further action, accuracy would be limited to planning and INS accuracy. If you discover an error on the radar display or in the HUD, you should slew the cursors or HUD symbol over the point of interest. With the radar above STBY, the slew rates will be optimized for the radar cursors and may seem fairly sensitive while slewing HUD symbols. Once you've slewed the cursors for one steerpoint, that cursor correction carries over to subsequent steerpoints. So, if the INS had drifted off approaching the IP, you could slew to correct the error and then switch to the target and the steering should be good for that steerpoint also. If you want to get the steering back to where the INS thinks the point is, mode select CZ (cursor zero) under MISC to zero out previous cursor inputs. Remember, the bearing pointer and DME on the HSI are always to the INS estimate of the steerpoint.

#### 5.11.13. CCRP—DIR AIM

AGR is not used for CCRP deliveries so ensure system altitude is accurate. Update with an ACAL, if necessary. With no other pilot input, the weapons steering will be direct to the INS estimate of the destination position.

Switches:

- Target coordinates—verify.
- Data knob—not in DEST.
- Thumbwheel—set desired destination or mark point.
- *NOTE:* Mark points do not allow the use of offsets and may degrade accuracy since mark point elevations are assumed to be the same as the steerpoint selected at the time of the mark.
- DIR AIM—selected.
- FCR—AUTO, GM, SEA 1/2, or BCN (usually GM).
- SCP—AG selected.
- Verify—CCRP mode, weapons profile, and weapons type/quantity.
- Master arm—SIMULATE or MASTER ARM.
- HUD—verify CCRP, SIM, or ARM.

#### Radar Update:

- **Scope Range.** Use the lowest scope range that displays the cursors/target area in the top half of the scope. Continue to reduce the scope range, if necessary, as the cursors move to the lower half of the scope.
- **Antenna Elevation in the Detent.** If the target has significant vertical development, it can be used to help identify the exact position of the "peak" by tilting up to reduce the size of the return.
- **Gain.** Adjust the gain to minimize background clutter. Prior target study helps you develop a big to small pointing system of radar significant details to help locate the target. Once you have positively identified the target return, adjust gain to sharpen target contrast from background clutter.
- **Slew the cursors over the target return.** RTN-TO-SRCH to expand the display and refine the cursor placement.
- Continue to refine cursor placement and gain control.

#### Considerations:

- Cross check HUD steering cues and fly the FPM to the steering line.
- The maximum range toss anticipation cue will appear 2 seconds prior to the solution cue.
- A 5 G pull when the solution cue is displayed will result in a release at 45° nose high and represents a maximum range release. Delaying the pull past this point will result in decreasing release angles until the solution finally reaches a level flight release.
- Execute the planned recovery following release.

#### 5.11.14. CCRP—Offset Aiming

Offset aimpoints are used to help pinpoint radar "show" targets or to locate radar "no-show" targets. The OAPs are entered as a true bearing and range (in feet) from the selected destination. The elevation of the OAP must also be entered to ensure accurate HUD symbology placement. The data is entered by depressing the desired OAP button with the thumbwheel on the appropriate steerpoint and the data knob in destination. DATA OPT to E/N to enter the elevation.

- Switchology is the same as for DIR AIM deliveries.
- Radar scope range and gain control are the same as in direct aim.
- In an F-16B, be sure you have control of the radar.

The use of the OAPs helps develop a pointing system to make target identification easier. Depressing the OAP buttons will cause the radar cursors to move from the steerpoint to the selected offset point. Check the location of the OAPs prior to going to expand to ensure that the cursors move to the correct position. In expand, the cursors are set at half-scope range and OAP selection will shift the map display rather than the cursors. Be sure that the point you choose to slew on corresponds to the selected aiming reference, i.e., OAP 1 or OAP 2. Whether you select DIR AIM, OAP 1, or OAP 2, steering is always to the thumbwheel destination, adjusted for cursor inputs. Anytime you make a significant error with a slew

input or if the scope relationships just don't appear to be correct, you can return to raw INS data by rotating the DATA knob to MISC and mode selecting the CZ function.

#### 5.11.15. VRP-CCRP (VCRP)

The VRP option is available anytime a non-zero value has been entered for VRP range. While OAPs provide a method of updating radar sighting to a target, VRP provides a visual means of doing the same thing. Once VRP data has been entered the HUD will display a small (6 mil) circle at the programmed bearing and range. The HUD symbology can be slewed over the point using X/Y cursor inputs and/or the pilot can overfly the point and designate with the designate/return to search switch to update the FCC steering.

Data entry:

- Place the data knob to WPN DEL and data opt until you see VRP.
- Data opt one more time to enter true bearing and range in feet.
- Data opt again to enter elevation.

Considerations:

- Other switch setup is the same as for CCRP using DIR AIM except that the HUD will reflect the VCRP option rather than CCRP.
- With no pilot input, steering will be to the INS estimate of steerpoint position.
- Find the target or OAP returns on radar and slew the radar cursors to update steering.
- Find the RP or target visually and slew the appropriate HUD symbology over the point to update steering.
- Fly directly over the planned RP and designate with the designate/return to search switch. The FCC will instantaneously shift steering to the programmed bearing and range. This will occur regardless of thumbwheel selection or your actual position in space at designate. If you designate over the wrong point, steering will be in error. To reset the update, exit the mode. Upon reentering, the overfly input will be gone but any prior slew inputs will remain.
- No designates or slews are available if the radar is the normal air mode (NAM) or if the FCC or radar are off
- In the F-16B, be sure you have control of the radar in the front seat or the designate switch will be inoperative.

#### 5.11.16. LADD

The low altitude drogue delivery (LADD) mode was originally designed for delivery of retarded weapons with an airburst fusing requirement (Figure 5.20). Currently the mode is most often used to loft free-fall airburst type weapons. Actual weapons release computations in the FCC are very similar to CCRP with a few notable exceptions. The LADD mode replaces the maximum range CCRP solution with a programmed 4 G pull to a 45° climb angle. This pull-up maneuver occurs at a pilot entered pull-up range. The LADD mode allows the pilot to enter a LADD time of fall (TOF) which enables the FCC to compute and compensate for average wind effect on the bomb after release. With a value other than zero entered in LADD TOF, the FCC will adjust the programmed pull-up range for variations in GS.

##### 5.11.16.1. LADD MRA

To ensure fuse function and minimum safe escape from the weapon, a minimum release altitude (MRA) can be entered by the pilot. If the MRA value is greater than zero the weapons release will only occur at or above the MRA value. Loft deliveries can be performed using either CCRP or LADD delivery modes. The unique features of the LADD mode mentioned above make it the better mode for airburst-type weapons. While the LADD program is based on a 4 G pull-up to a 45° climb, weapons release will occur at any point that the computer sees a solution. The only exception to this is if the pilot enters a MRA. In that case, the aircraft must pass the MRA altitude before release will occur. MRA considerations may delay weapons release for up to 5 seconds after the initial solution. This delay will

result in a long bomb. The MRA value is retained by the FCC after power down and must be zeroed by the pilot.

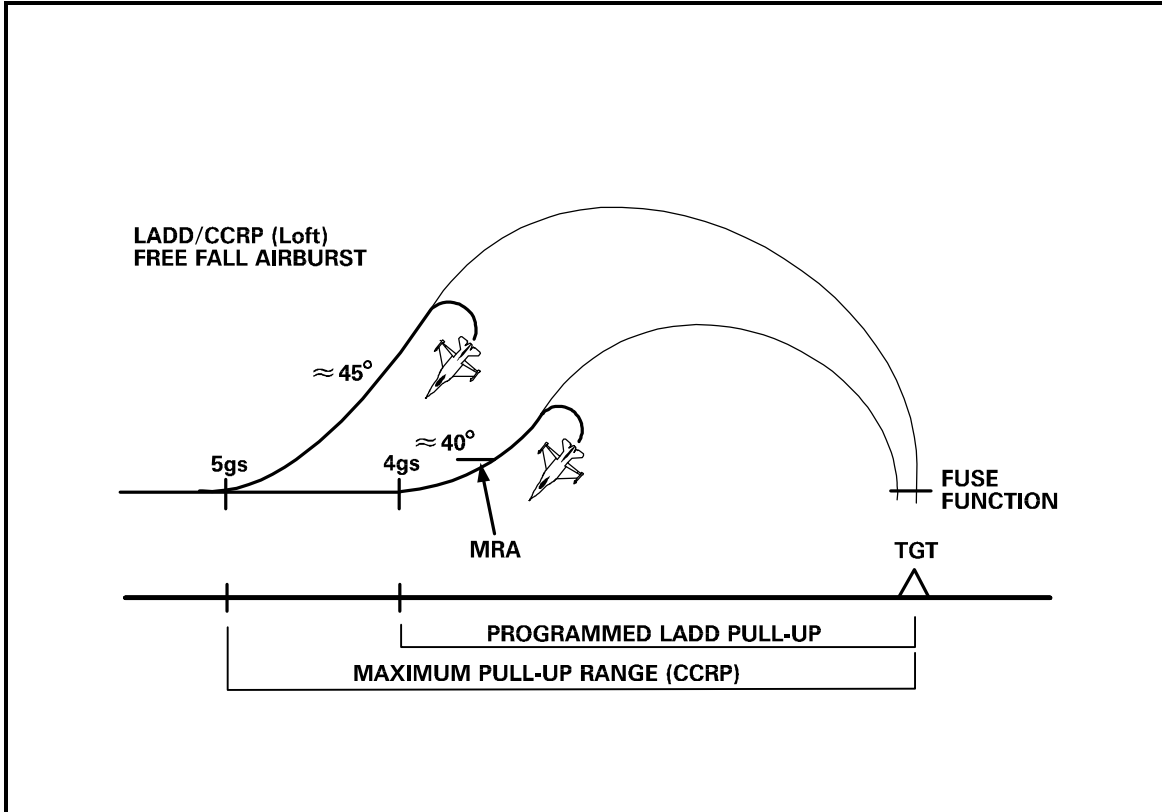


Figure 5.20 LADD/Loft Profiles

#### 5.11.17. Visual Initial Point (VIP) Mode

The VIP mode is used when the target position is known relative to a specified initial point (IP) which has been entered in the FCC mission planning table. VIP mission planning data is entered through the FCNP. The mode uses an IP, represented by a destination thumbwheel location, and a target located by bearing, range, and elevation. Data is entered with the FCNP data knob in the WPN DEL position after VIP appears in the alpha display. The VIP and BCN bearing, range, and elevation data are stored at the same FCC location. Entering BCN data will change VIP data and vice versa. Bearing from the IP to the target is entered to the nearest 1° (true) in the LMD. Range to the nearest foot is entered in the RMD, with B/R displayed. The target elevation above sea level is entered in the LMD, with ELV displayed. The maximum range that can be input into the FCC is 99,999'. VIP is a selectable option in the A-G mode on the SCP. The RCP mode knob is positioned above STBY and master arm switch is positioned to MASTER ARM or SIMULATE. HUD symbology will appear. The IP location is marked by the diamond, and the A-G TD box is located on the target. The 6 mil circle is positioned on the HUD at the pop-point (bearing and range from the diamond and elevation are entered under the OAP, if selected). The RDR cursor/enable switch can be used for target/IP refinement. The cursor slew gains are optimized for the TD box, if the radar is in AUTO. If the radar is in a GM mode, slew is optimized for the radar cursors, but the diamond symbol will follow. The radar remains in whatever mode is selected on the RCP. If AUTO is selected, the radar is commanded to STBY. Bombing geometry can be updated by either designating at the overflight of the IP or slewing target/IP/pop-point symbols over the appropriate locations.

##### 5.11.17.1. Visual Updates

In the first method of visually updating the bombing geometry, the pilot designates at the time of IP overflight. The position of the diamond symbol, the pop-up-point, and the TD box are updated and can be

slewed if further refinements are required. The pilot follows the attack steering guidance and depresses the weapon release switch for consent of automatic weapon release. If after the overfly designation the target is visually acquired, the pilot has the option, by depressing the designate switch a second time, of causing the VIP mode to be functionally the same as the dive toss mode. The HUD will continue to display VIP. After this second designation, the TD box will cage about the FPM and slew is available for the TD box. The radar is now commanded to A-G range on the TD box (also like the dive toss mode). Either weapon release or designate can be used to designate the target. A subsequent designate will cage the TD box about the FPM. All VIP related slewing and designate are inhibited if the air mode is selected on the radar control panel (RCP) and slew/designate will apply to the radar only. In the second method of visually updating the bombing geometry, the pilot does not overfly the IP, but slews the TD box over the target, the circle over the pop-point, or the diamond over the IP and follows the steering and release cues. The pilot has the option of performing a double designate and performing a dive toss type of delivery. Following the IP overflight designate and prior to subsequent designates, dogfight or missile override can be selected without disrupting the VIP symbology. All VIP related slewing/designates are inhibited while in the dogfight or missile override mode. When dogfight/missile override is deselected, the VIP post designate mode returns and the cursors retain their post designate position. The VIP mode is reinitialized by performing one of the following:

- Changing modes on the SCP and reselecting VIP.
- Designating twice in VIP (mode is now VIP post-post designate), changing modes (either on the SCP or the throttle) and reselecting VIP.

Employment is essentially the same as for VCRP except VIP must be selected on the SMS and IP (versus TGT) must be the selected thumbwheel position. (The thumbwheel may be advanced to the target after a designate at the IP.)

## **5.12. System Altitude Errors**

Unknown or uncorrected system altitude errors have a negative impact on the accuracy of the F-16's computed weapons deliveries (non-AGR). A comprehensive understanding of factors affecting TD box placement, the impact a system altitude error has on delivery accuracy, and methods to correct system altitude errors is required to effectively employ the F-16.

### **5.12.1. Factors Affecting TD Box Placement**

There are many factors which may affect TD box placement. Target coordinates and elevation data as extracted from reference charts must be as precise as possible. The data extracted from a 1:500,000 is less accurate than from a 1:50,000 chart. A second factor affecting TD box placement is the accuracy of initial INS alignment. Get the system as accurate as possible. Don't accept a second-rate INS. The final factor affecting TD box placement is the accuracy of INS estimates of present position and FCC (with INS input) estimates of current system altitude. The avionics system assumes its estimates of present position and system altitude are correct and then proceeds outward to the target position to display symbology. Therefore, if the estimates of present position and system altitude are incorrect, the display of target symbology will also be incorrect.

### **5.12.2. TD Box Placement With Errors**

The placement of the TD box is on a three axis graph (Figure 5.21). The X axis of the graph represents latitude, the Y axis represents longitude, and the Z axis represents elevation of the target. The TD box will not be on the target, if any one of these values is erroneous. For example, an incorrect elevation value and/or system altitude error affects TD box placement along the Z axis (Figure 5.22). The TD box appears long of the target if the elevation entered is higher than actual or the system altitude is low. The TD box appears to be short of the target if the elevation entered is lower than actual or the system altitude is high.

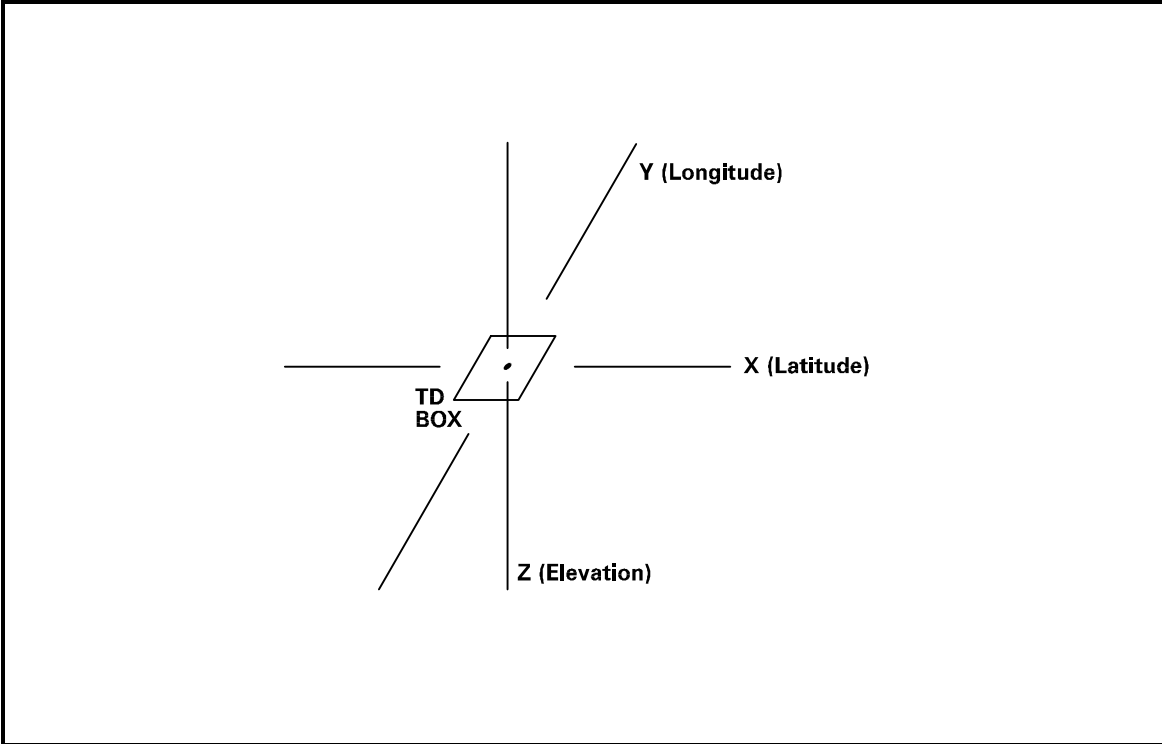


Figure 5.21 TD Box Three Axis Graph

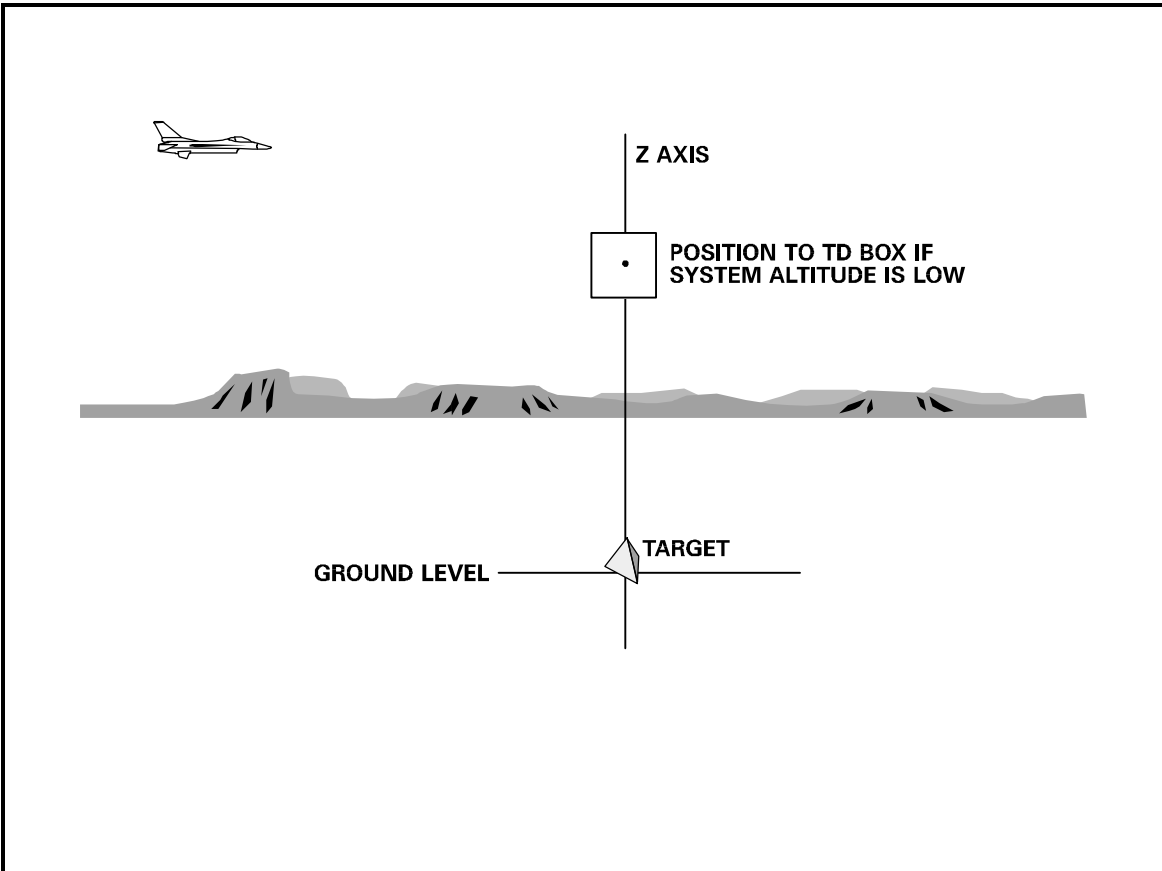


Figure 5.22 TD Box Error Example



System altitude is low when the TD box appears to be positioned long of the target and its actual position on the three axis graph is high of the target (Figure 5.23). Approaching the target/steerpoint the actual position of the TD box remains constant. The position of the TD box appears to track to a point under and behind your aircraft, but toward the target in a time-sequenced profile view.

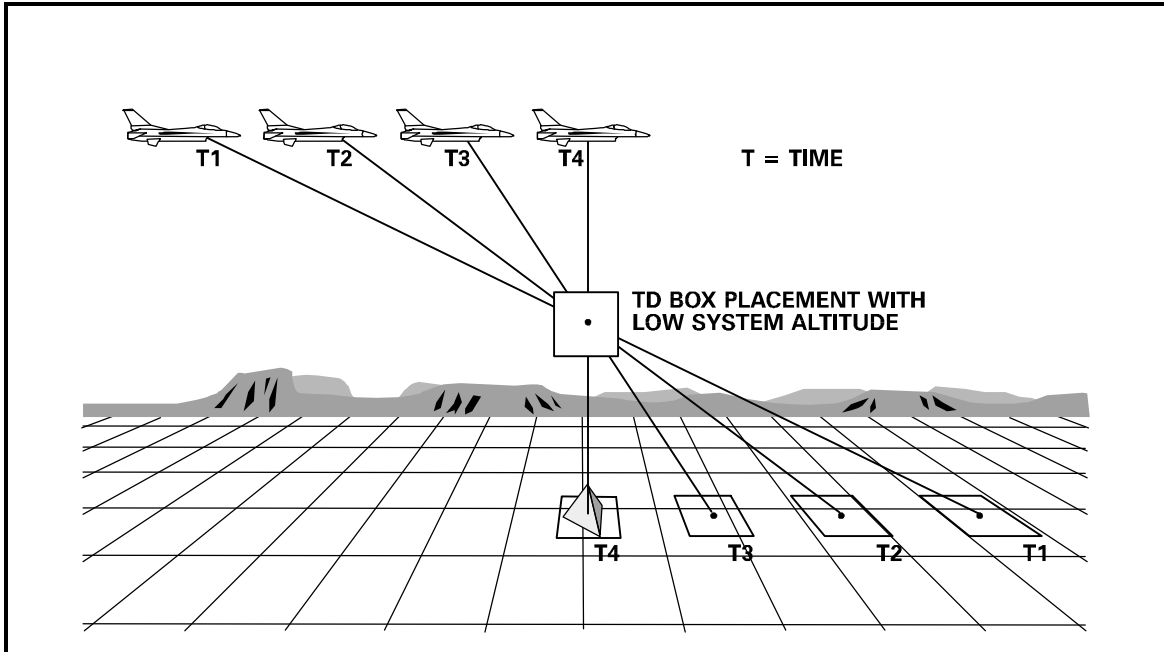


Figure 5.23 System Altitude—Low

The opposite is true when system altitude is high (Figure 5.24).

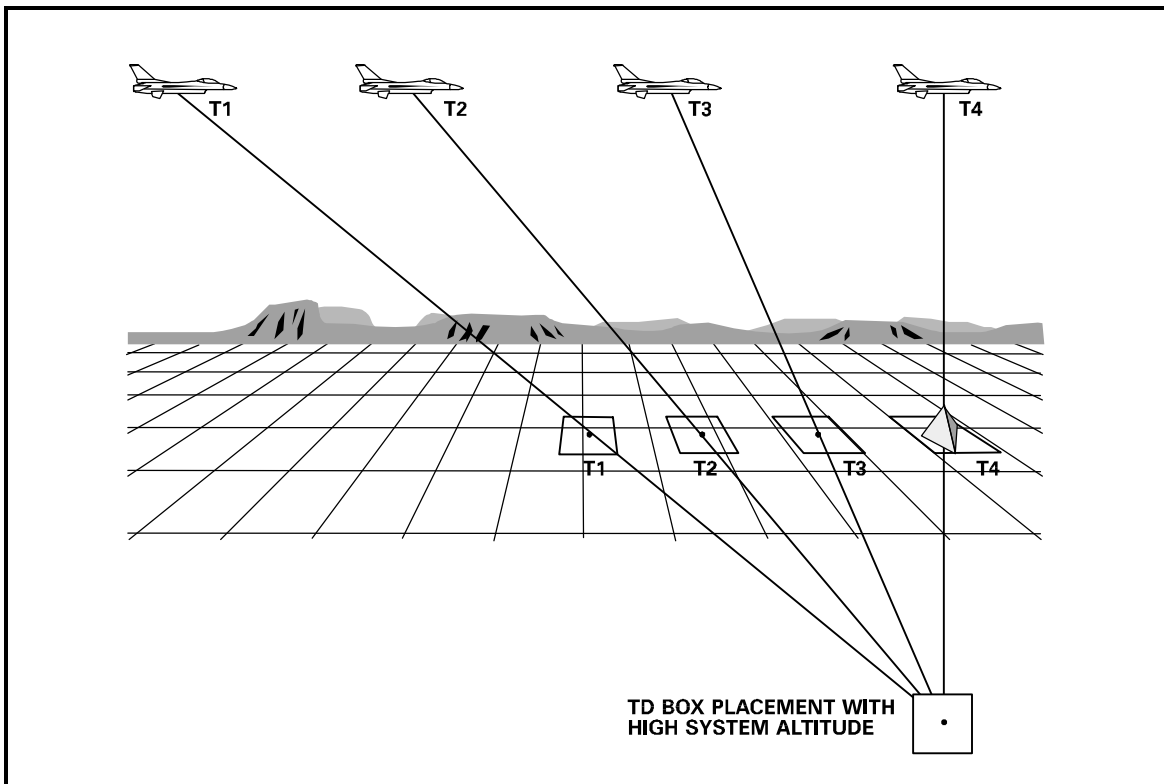


Figure 5.24 System Altitude—High

System altitude errors definitely affect weapon delivery accuracy. A review of blind delivery events and visual delivery events is required to understand weapon delivery errors due to incorrect system altitude. In a blind delivery event, assume the radar cursors are correctly positioned on the aimpoint, and the TD box location is ignored. If system altitude is high, a short impact occurs because the FCC thinks the target is below the actual elevation and computes an early release. The TD box appears short of the target and the system tries to drop the weapon through the TD box. However, bomb impact error will be less than TD box positioning error (Figure 5.25).

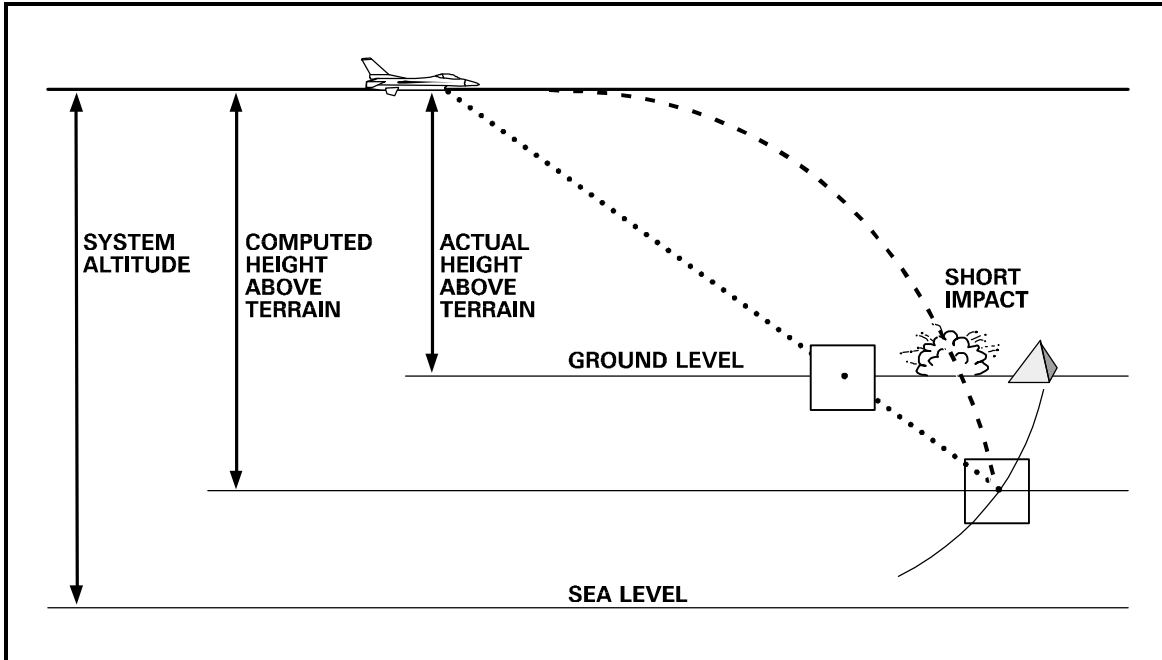


Figure 5.25 Blind Delivery—High System Altitude

A low system altitude results in a long impact because (Figure 5.26) the FCC thinks the target is above the actual elevation and computes a late release (low system altitude is long bomb).

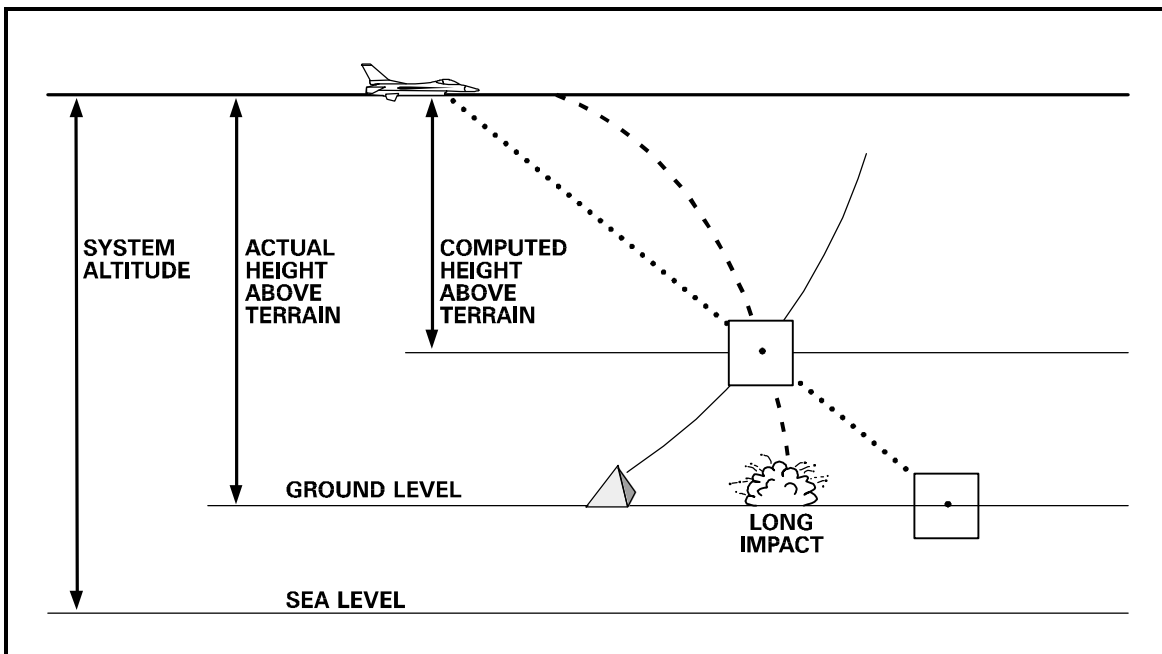


Figure 5.26 Blind Delivery—Low System Altitude

Impact errors due to system altitude inaccuracy in visual deliveries are opposite those experienced in blind deliveries. Visual events such as DTOS employ sighting through the HUD. TD box location is set via the HUD line-of-sight (LOS) and ignores radar cursor placement. The same errors occur in CCRP if 6–12 o'clock TD box errors are corrected using the HUD as a reference. Even with the TD box on the target, if system altitude is high, the FCC thinks the target elevation is below actual and computes a later release point resulting in a long impact (Figure 5.27).

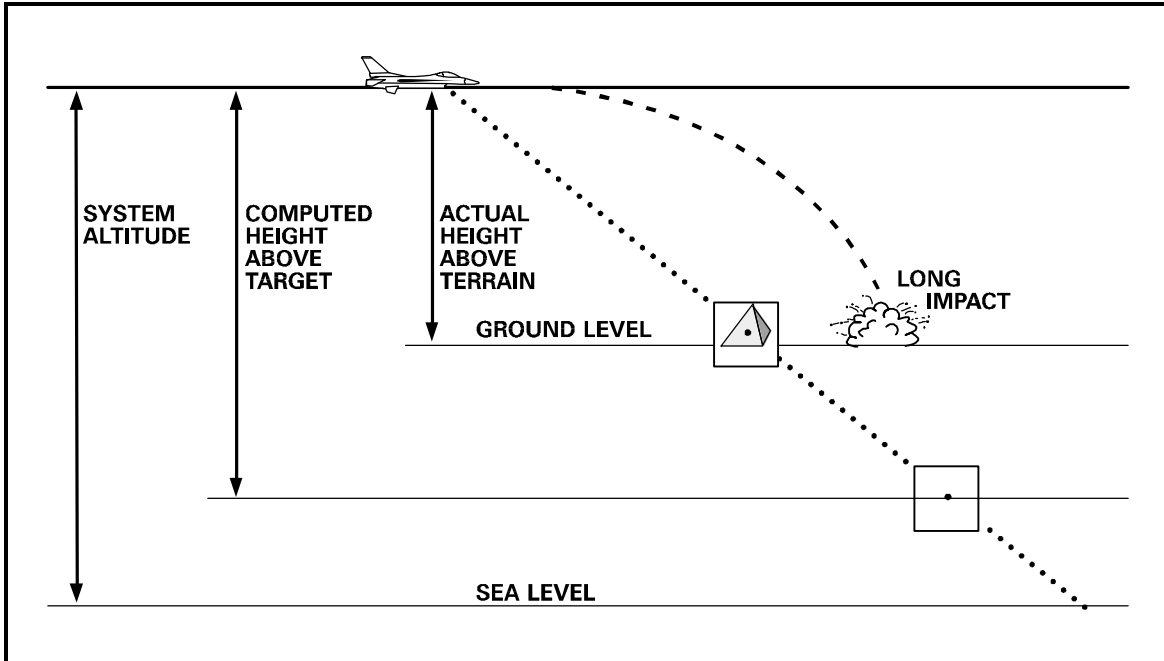


Figure 5.27 Visual Delivery—High System Altitude

If system altitude is low (Figure 5.28), the FCC thinks the target elevation is above the actual elevation and computes an early release point resulting in a short impact.

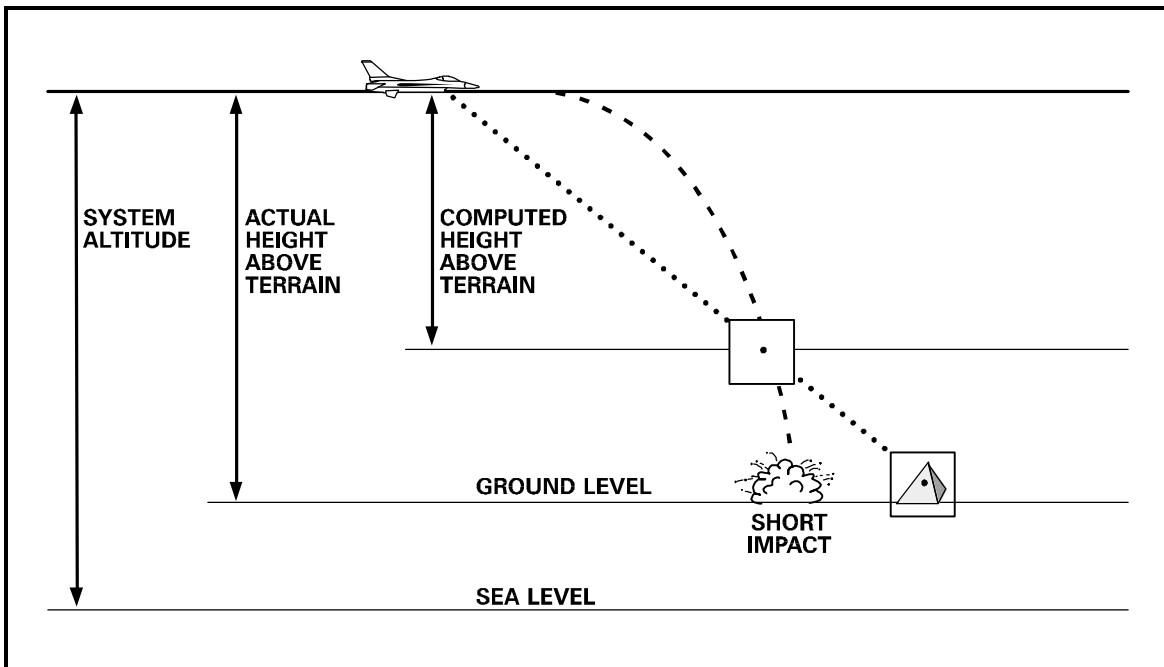


Figure 5.28 Visual Delivery—Low System Altitude

### 5.12.3. Correcting System Altitude Error

The best method to correct for a known system altitude error is to do an altitude calibration (ACAL). There are a wide variety of methods which include radar altimeter (RALT), FCR, HUD, or targeting pod (TGP) to update system altitude. To accomplish an ACAL, select ACAL on the ICP with the navigation master mode accessed. The communications, navigation, identification (CNI) page is displayed on the DED. Select RALT on the ACAL page. Designate and a delta altitude value is displayed on the ACAL page of the DED. Depress ENTR on the ICP to update your system altitude, if you agree with and accept the delta altitude. Don't enter it into the computer, if you don't agree with the data (Figure 5.29). Target elevation, in lieu of an altitude calibration, can be adjusted to account for system altitude errors. Increase the target elevation, for a high system altitude, and decrease the target elevation for a low system altitude. The problem with this correction method is determining the magnitude of the elevation correction. It is a trial and error solution. A more realistic and the most often used method to correct for system altitude error is to aim short or long of the target when BARO bombing or select a delivery mode that uses AGR.

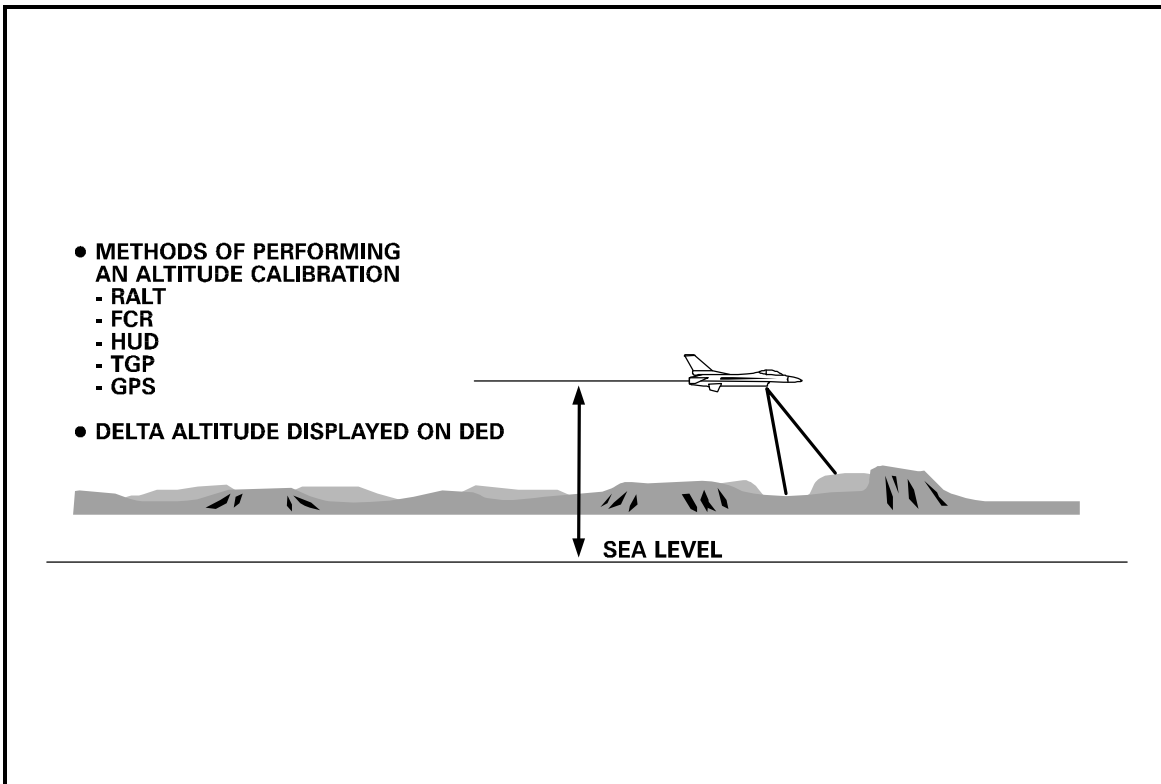


Figure 5.29 Known System Altitude Error

### 5.13. Controlled Range Patterns

Basic/Initial qualification may be accomplished using the "box" pattern (Figure 5.30). Curvilinear patterns are suitable for tactical deliveries. Once mission ready, pilots are required to use tactical patterns, such as curvilinear or pop-up, for valid weapons delivery "Hits."

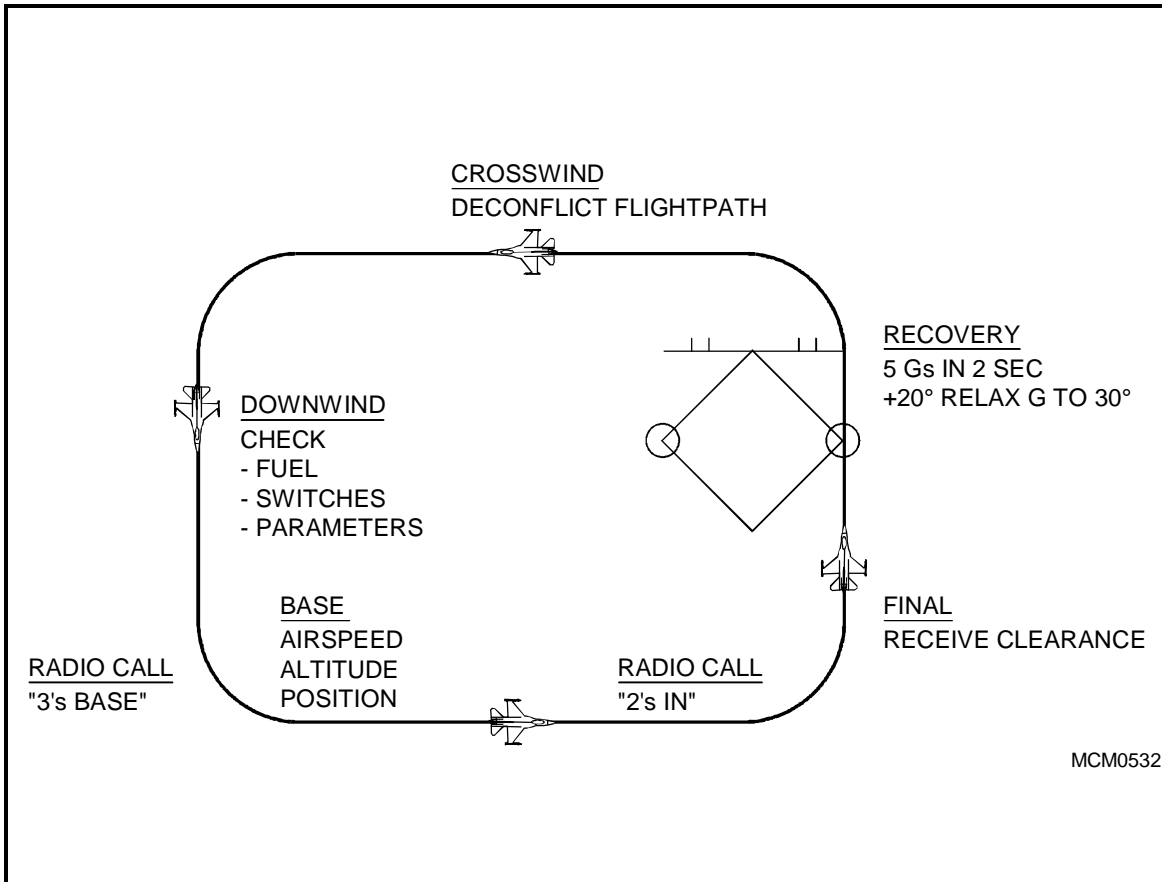
#### 5.13.1. The Box Pattern

The pattern activities described here will span approximately 80–90 seconds.

##### 5.13.1.1. Crosswind

When turning crosswind (or any other place in the pattern), realize that you may be turning inside the preceding aircraft (the "coffin corner"). Roll out or ease off momentarily and look outside as well as inside your turn until you are sure your turn is clear. If you are still not sure who is where, ask! **Example:** "Viper 1, say posit". All other flight members should stay off the radio except to resolve the situation: "Viper 1 is turning base". Once the visual is regained, or SA confirms there is no conflict, the

affected fighter should transmit "Viper 2 is visual" or "Viper 2, continue". If the situation can not be immediately resolved, a knock-it-off will be called. Maintain altitude separation until the confusion is resolved to avoid passing or colliding with the preceding aircraft. This will also aid in keeping the pattern from becoming uncomfortably tight. The preceding aircraft will normally be in your ten or two o'clock position.



**Figure 5.30 Conventional Range Pattern**

#### 5.13.1.2. Downwind

The flight leader will establish the downwind leg ground track. This is not a hard and fast position and may be varied by individual pilots to adjust spacing. Downwind should be wide enough to allow for wings-level stabilization on the base leg.

In low-angle patterns (20° or less), adhere closely to the pattern airspeeds and altitudes. In higher altitude delivery patterns, climb at an airspeed no slower than the planned base leg airspeed. Plan to arrive at base leg altitude prior to actually turning base. On hot days or with higher gross weights, afterburner may be required.

While on downwind, prepare armament systems as necessary. Evaluate pattern spacing and analyze delivery errors. Analyze winds and adjust pattern as necessary to fly the correct ground track.

A four-ship is properly spaced when an aircraft is at each of the four corners of the pattern. Alter the distance abeam the target on downwind as necessary to adjust pattern spacing.

#### 5.13.1.3. Base

Base position is one of the most critical positions in the pattern. It determines proper dive parameters and is normally the largest cause of poor parameters when improperly flown. There are three major conditions required to begin a successful roll-in. Airspeed, altitude and base position. Two of these are controlled in the cockpit (airspeed and altitude). Base position can be an ambiguous point determined

through calculations done during pre-flight planning. These calculations can be applied in the cockpit through two sources—eyeballs (visual point on the ground or visual assessment of the wire) or the HUD. With an accurate INS, the base position calculation can be used in the HUD in the CCRP mode. This can be an accurate base position range used for not only a box/curve pattern, but also a pop-up and roll-in point for low and high altitude attacks. A practice of using CCRP with a pre-planned roll-in range could enhance your attack parameters. The following procedures should be used when flying the conventional range pattern:

- DO NOT vary base leg position to adjust pattern spacing. If you are too close behind the aircraft ahead, turn base at the normal point and plan to go through dry on final. Adjust your pattern on downwind.
- Call turning base (e.g., "Three, base").
- Delay your base call (not the turn), if necessary, until the aircraft ahead has received clearance from the range officer.
- When established on base, make last-minute adjustments in heading to compensate for winds or actual ground track. Adjust airspeed.

#### 5.13.1.4. **Roll In**

Consider the winds at pattern altitude and adjust the final roll-in point as necessary. As you begin your final turn, should you determine that you are too close or too wide on base, you may still achieve a proper dive angle by adjusting nose attitude during roll in. Compensate for being too close by over banking and lowering the nose sooner. Avoid an extreme nose-low attitude. Abort the pass if dive angle is over 5° steeper than planned (10° if the planned recovery altitude is above 10,000 feet AGL). Compensate for being too wide by reducing bank and maintaining the nose level longer in the final turn. Realize that airspeed on final approach depends largely on power setting. You may choose to set power prior to roll in or you may wish to use military power throughout the turn, retarding the throttle to the proper setting on final. Most pilots prefer to use military power for the roll in to preclude an inadvertent slow speed/high AOA situation. Lead your roll in by one turn radius (usually about 3300' to 4500' depending on TAS) to prevent angling. The amount of allowable angling varies for different ranges, and depends on range officer judgment. However, up to 10° is normally allowable. Never overfly manned range towers. If it looks and/or feels bad, go through dry.

#### 5.13.1.5. **Final**

When rolling out on final during any attack, make certain you know exactly which is your target and release ordnance only when you are positive of its identification.

#### 5.13.1.6. **Recovery**

Recover your aircraft above the minimum recovery altitude regardless of whether your ordnance is away or not. Recoveries should be flown IAW Dash 34 safe escape, MCI 11-F16 Vol 3, or minimum altitude for AAA, based on the type of munition, threat, and target area tactics.

#### 5.13.1.7. **Climbing Safe Escape Maneuver**

Normally, a climbing safe escape maneuver (CLM) is used for dive angles greater than 20°. After release, obtain 5.0 G's in 2 seconds. As the nose approaches the horizon, apply military power. G is maintained to a 20° climbing flight path angle and then relaxed until 30°.

#### 5.13.1.8. **Turning Safe Escape Maneuver**

For dive angles 20° or less, a CLM or turning safe escape maneuver (TSEM) may be used depending on MAJCOM or local guidance. Refer to the Dash 34 for TSEM procedure. *CAUTION:* There are two types of TSEMs: Level Turn and Descending Turn; ensure you refer to the appropriate one.

#### 5.13.1.9. **Turn to Crosswind**

Begin the turn to crosswind as soon as your aircraft's nose is definitely above the horizon and power has been advanced for the climb back to base altitude. Any delay will extend the pattern and present the risk of the following aircraft turning inside you.

#### 5.13.1.10. **Pattern spacing**

Adjust downwind as necessary and place base leg in the proper position every time.

#### 5.13.1.11. **Radio procedures**

Refer to appropriate AFI/MCI, "Radio Procedures on a Controlled Range" and consider the following:

- If turning base and the pilot in front of you calls in, allow the range officer to clear him before making your base call.
- Acknowledge all radio calls directed at you except when "cleared" by the range officer.
- Do not hesitate to request clearance if the range officer has not cleared you to drop. **DO NOT DROP** without clearance.
- If you go through dry, call, "Off dry."

#### 5.13.2. **Curvilinear Deliveries**

Curvilinear deliveries are used primarily for delivering ordnance from shallow dive angles at relatively low release altitudes (Figure 5.31). The use of shallower dive angles and lower release altitudes may be necessitated by the type of ordnance being delivered, weather in the target area, or other tactical considerations. A curvilinear approach consists of constantly changing heading, altitude, airspeed, and G loading to arrive on final for a short tracking solution, thus decreasing AAA hit probability. It may consist of almost any flight path which will allow you to get from roll-in altitude to wings level on final at the planned track point. The most common technique is a descending turn in 30°–60° of bank using MIL power initially. Approaching desired release airspeed, retard the throttle as required to hold airspeed. Play the last half of the turn to arrive on final with the bomb fall line through the target for CCIP deliveries. For DTOS deliveries fly the TD box to, or just short of, the target. Cross-check your parameters and make any adjustments necessary to meet your planned release minimums. Designate/pickle and initiate the recovery. This technique is good for LAS, LAHD, LALD, and LLLD deliveries. Curvilinear deliveries may be flown as follows:

- The crosswind, downwind, and base leg are similar to the basic box pattern.
- Begin the curvilinear approach to final at approximately twice the distance of the basic delivery turn to final—6000' prior to an imaginary extended centerline through the target—by lowering the nose slightly, increasing power, and simultaneously establishing a 30°–60° bank.
- Adjust dive angle, power and bank angle throughout the final turn to arrive wings level on final with the target approximately two-thirds of the way down the bomb fall line between the FPM and the CCIP piper for CCIP. Wings-level tracking time on final should not exceed 5 seconds with 3–4 seconds desired.

Curvilinear deliveries may also be flown by initiating the turn to final from a modified downwind position. The key to starting the pattern from other than the base leg position is to adjust the downwind altitude and position so that a turn can be made to put you at or near the curvilinear base leg position. You may fly a higher downwind altitude and make your turn to final a continuous 180° turn. However you get there, whether a descending turn or a level turn, the desired objective is to arrive at the planned track point with the proper parameters (Figure 5.32).

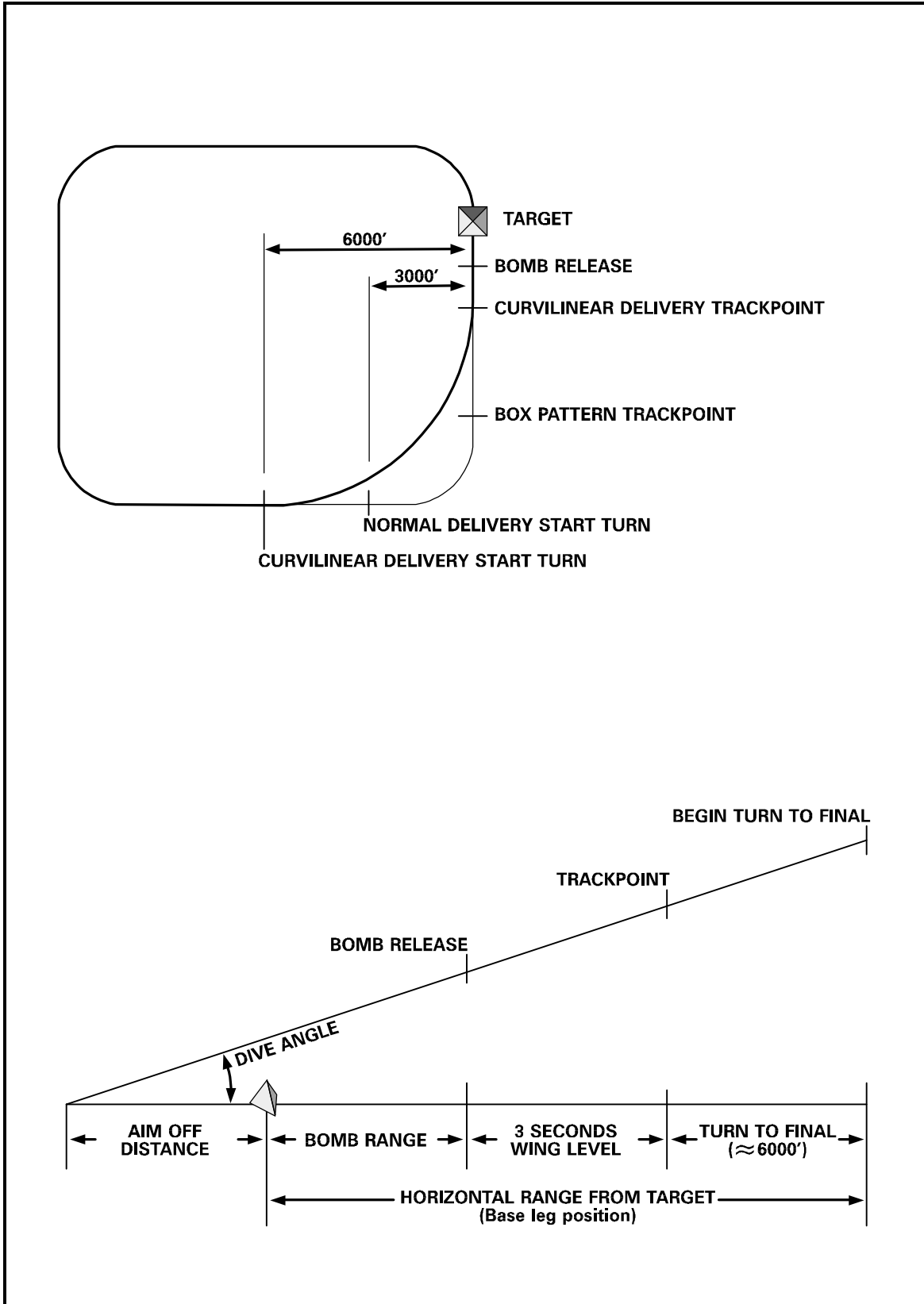
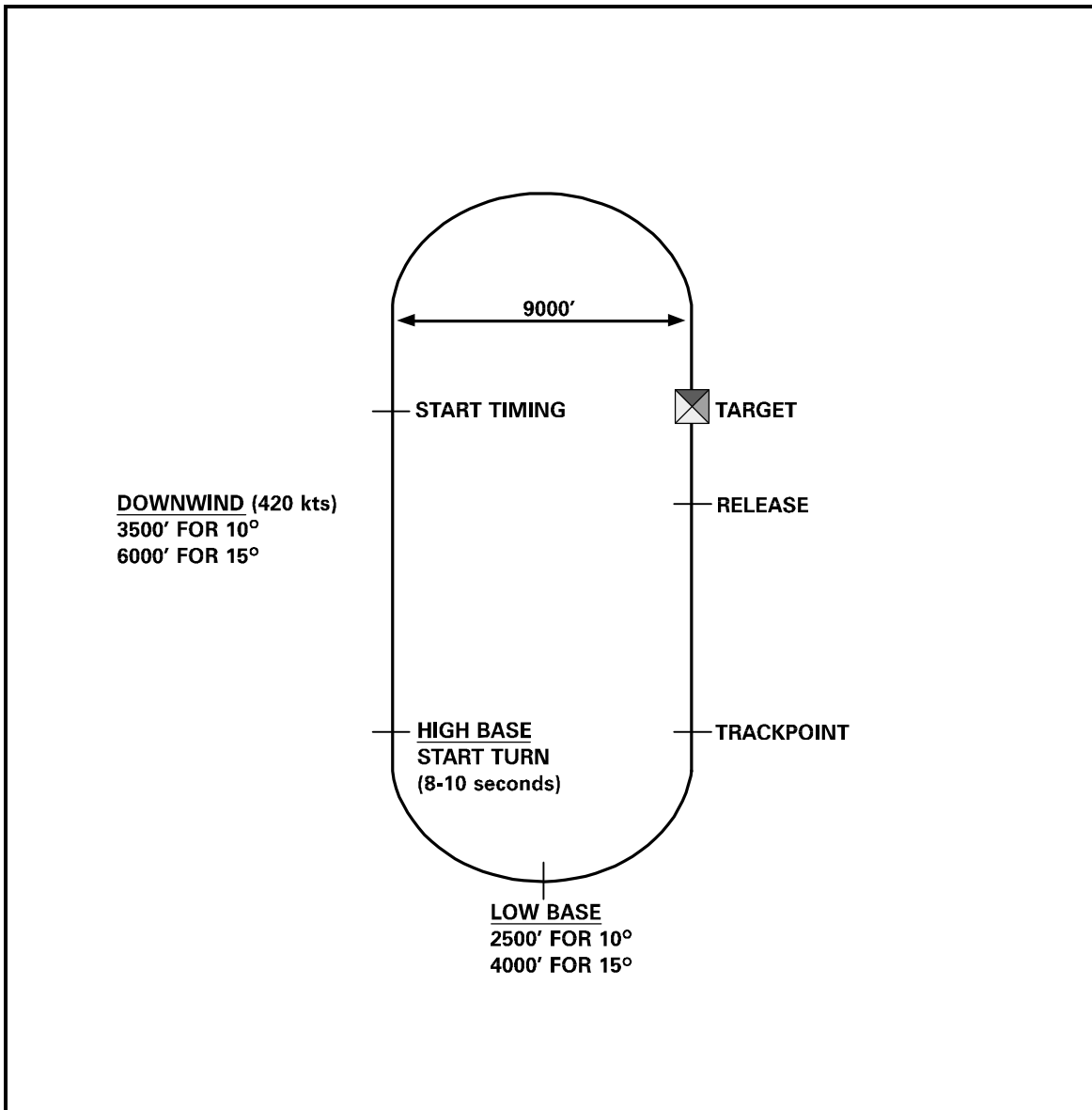


Figure 5.31 Curvilinear Pattern



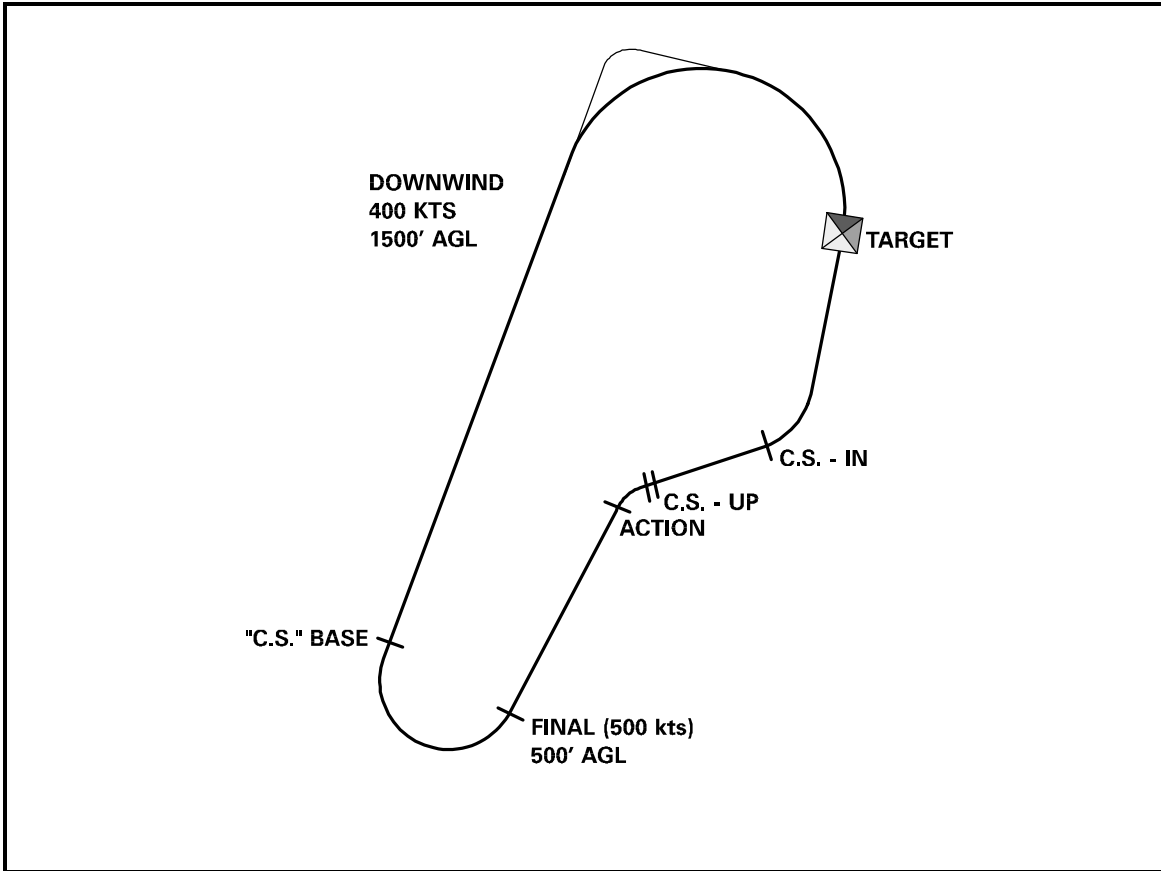


**Figure 5.32 Curvilinear Pattern (Continuous Turn)**

### 5.13.3. Pop-up Deliveries

Patterns should be established to enable pilots to fly pop-up deliveries as those discussed previously. Figure 5.33 depicts a typical pop pattern. Use caution for descending turns at low altitude. Pop-up deliveries may be flown as follows:

- The base position should be based on a DME range from the target that will allow a descending MIL power turn to point at the target NLT 1–2 NM prior to the action point.
- Accelerate to 480-540 KCAS or as required for the delivery and action at the specified range.
- Fly the attack as discussed previously.



**Figure 5.33 Typical Pop Pattern**

#### 5.13.4. Range Departure

When recovering from his last pass, the flight lead will climb while slowing to the planned rejoin airspeed. Prior to rolling in on final for your last pass, attempt to acquire the preceding aircraft. This will make later acquisition easier. Execute a normal pass and recovery. Report all aircraft you have in sight. Examples:

- "Viper Two off, one aircraft in sight."
- "Viper Three off, two aircraft in sight."
- "Viper Four off, three aircraft in sight."

If you don't have visual contact with all preceding aircraft, say so immediately. Do not begin a turn until you have visual contact or until positive altitude separation is assured. Realize that angle-off can be rather high during off-range rejoins. When coupled with high airspeeds, this situation often requires more judgment and skill than do normal rejoins. Avoid dropping low during rejoin. Should a frequency change be necessary prior to your rejoin, remember aircraft control takes precedence over a channel change.

At your earliest convenience, safe all your armament switches. The flight lead will call for an armament safety check and all wingmen will confirm their switches are safe and acknowledge. Complete an ordnance check when directed.

#### 5.13.5. Foul Avoidance

Minimum recovery altitudes are established based upon blast and fragmentation envelopes of live ordnance. These altitudes are generous in that they allow you to release at the closest possible slant range and still effect a safe and proper recovery. Violation of established minimums places life and aircraft in

jeopardy; accuracy seldom improves with such action. The range officer, whose decision is final, will issue fouls and/or suspend your operation on the range for any of the following reasons:

- Recovering below minimum altitude.
- Abrupt or dangerous recoveries.
- Firing past the strafe foul line.
- Delivery of ordnance on a wrong or unauthorized target.
- Double bursting strafe.
- Releasing ordnance without clearance.
- Lazy pull-offs.
- Any act deemed unsafe.

For the first foul, you will receive a gross error bomb or zero strafe hits for that pass. If the pass was dangerous, you will be ordered off the range. If you are issued two fouls on any mission, the range officer must order you off the range. Climb to prebriefed altitude and safe all switches. Adherence to the following guidelines will aid you in avoiding fouls:

- Know the minimum recovery altitude for each event and do not "press" past the planned release altitude.
- Begin each delivery pattern within proper parameters.
- Avoid any last minute tracking corrections which will carry you past release altitude.
- Do not attempt to observe the ordnance impact. Your most critical task is to safely recover the aircraft above the foul altitude/ground.
- Recover smoothly, using a guideline of 5 positive G's in 2 seconds. Do not bank in an attempt to air score your own bombs.

Most fouls come during low-angle strafe, and firing past the foul line is the most common way to get one. Reference to the foul line as well as the entire range environment with your peripheral vision will aid in avoiding this type of foul. Adherence to foul avoidance techniques will also aid in avoiding ricochets. If you are aware of a large number of rounds remaining on the last pass in strafe, consider opening fire a bit further out.

Being absolutely sure of your target is not confined to training on controlled ranges; it continues to be a very important factor anytime ordnance is used, even in combat. If you are not certain, GO THROUGH DRY!

#### 5.13.6. Malfunctions

Malfunctions discovered during preflight or any time prior to flight will be isolated or corrected, or abort the aircraft. Circumstances surrounding airborne malfunctions may vary considerably; all will require adherence to proper procedures and good judgment. These malfunctions fall into two basic categories: inadvertent releases and failure to release. Inadvertent releases are rare but serious.

##### 5.13.6.1. Inadvertent Release

An inadvertent release is the jettisoning, firing, or releasing of any ordnance, suspension equipment, or aircraft part which was not commanded by the pilot. If an inadvertent release occurs:

- The incident aircraft will abort, check armament switches safe, and be escorted home following the hung bomb procedures.
- Any remaining ordnance that presents a carriage or landing hazard should be expended in a suitable area (single pass, if practical).
- The pilot should note switch positions at the time of release to clarify subsequent write-ups.
- Initiate aircraft impoundment procedures as outlined in the appropriate AF or 55 series manual.

#### 5.13.6.2. No Release

A no release is most commonly caused by incorrectly set switches, releasing the pickle button early (quick pickle), malfunctioning SUU/TER's, or an SMS problem. More than likely your first indication of no release will be the range officer's declaration of a no-spot. If your switches were correct, you should suspect hung ordnance. On downwind, recheck the SMS for a RDY indication and note the quantity remaining. If the quantity did not step down, then the SMS never delivered a fire signal. A "quick pickle" (releasing the pickle button too soon) can cause this indication and will result in a no release. Continue in the appropriate delivery pattern, executing dry passes if necessary while analyzing the problem. Reattempts to expend may be accomplished as long as there are no other apparent malfunctions. Use caution not to become so engrossed in manipulating switches that you exceed pattern parameters. Certain avionics malfunctions will prevent releases:

- FCC FAIL means you cannot make computed releases but manual deliveries should work.
- If the SMS fails completely, you won't be able to release or jettison anything. Other SMS MFLs may indicate partial system or station failures.

#### 5.13.7. Jettison Procedures

Refer to Section III of the Dash 1 for jettison of external fuel tanks or any unsecure heavyweight/ live ordnance. Local procedures describe what to do when jettison is required. Wingmen should notify their flight leader as soon as they think a jettison may be required because it will take time and fuel to set up for jettison. Bingo fuel is not the time to start jettison procedures. Know the Dash 1 jettison limits for the ordnance/suspension equipment you are carrying. Refer to your checklist, if you are forced to land with asymmetrical stores.

#### 5.13.8. RTB And Landing With Hung Ordnance

Refer to appropriate AFI/MCIs, "Armament System Malfunction Procedures" and "Hung Ordnance and Dearn Procedures", and local restrictions.

##### 5.13.8.1. Strange Field Recovery With Hung Ordnance

In many cases, the strange fields you encounter in your local area may not be familiar with hung ordnance. The primary item to remember is to ensure the tower is informed as soon as possible, preferably before landing. It is also important that tower know if the weapons are live or training ordnance.

#### 5.13.9. Radio Failure

During complete radio failure, when confronted with a situation not covered in this text, appropriate 55 series manual, or the flight briefing, you are expected to exercise good judgment in whatever action you elect to take. Should the situation so dictate, do not be reluctant to use emergency actions which pertain to local flying operations. The following procedures will provide guidelines for actions during complete radio failure:

- Radio failure after range entry. Refer to appropriate AFI 11- series, Chapter 7 and local procedures.
- RTB with radio failure:
- If there is no standard local procedure to recover with radio failure, be certain that you understand what has been briefed.
- If your ordnance is hung, proceed in accordance with briefed procedures. Watch for flares or any other conditions which would require a go-around.
- The idea behind hung ordnance patterns is to safely recover the aircraft on the first attempt.

#### 5.14. Pop-Up Deliveries

A highly sophisticated and integrated SAM/AAA/air-to-air threat environment or weather may force a low-level ingress and pop-up attack. While such tactics place us within the AAA and small arms environment, a properly planned and executed pop-up attack should give us our best possible odds against SAM or air-to-air threats and, in addition, can provide surprise and deception to enhance survivability

against AAA. There are many variations of pop-up attacks. It is important that you understand the basics of the maneuver; namely how to plan and execute each type of attack. You will be establishing habit patterns and using rules of thumb which will ensure successful and safe attacks.

#### 5.14.1. Pop-Up Safety

Target acquisition and alignment with the proper target attack heading are critical on all deliveries. There is little time to decide if you have achieved your desired delivery parameters. If you are faced with parameters that you do not recognize or if you have any doubts about whether or not you should continue the pass, then either abort the pass or reposition. Immediately abort a pop-up attack if any of the following conditions arise:

- Actual dive angle exceeds planned by more than 5°.
- Airspeed below 350 KCAS (300 KCAS above 10,000' AGL).

#### 5.14.2. Pop-Up Definitions

Refer to Figure 5.34.

- Approach Heading—The heading flown during wings-level pull-up and climb.
- Attack Heading—The heading flown during the wings level attack. Also called the attack axis.
- Angle-Off—The difference between approach and attack heading.
- Direct Pop-up—Angle-off less than 15°.
- Offset Pop-up—Angle-off greater than 15°.
- Indirect Pop-up—Angle-off greater than 90°.

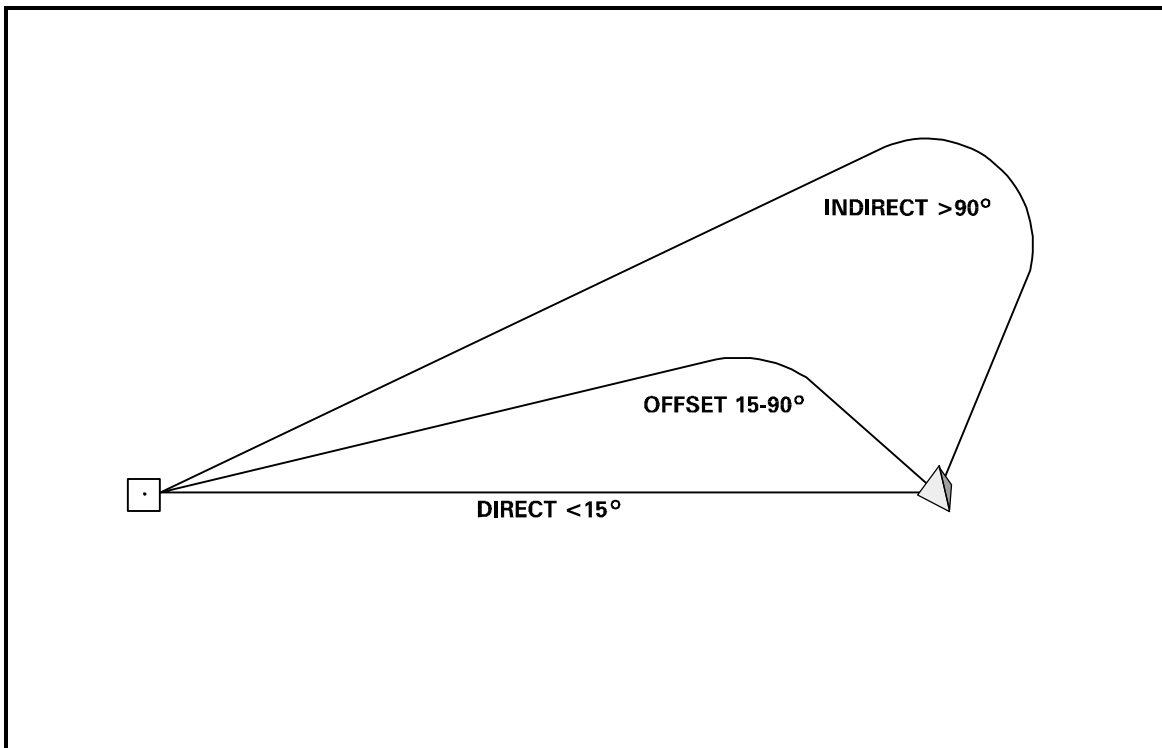


Figure 5.34 Pop-Up Definitions

#### 5.14.3. Offset pop-up definitions

Refer to Figure 5.35.

- Initial Point (IP). The point where the last leg to the target begins. Normally, the IP is prominent, unique, and 10 to 20 NM out from the target.

- Action Point/Range. The point/range from the target where you take offset for an offset or indirect pop-up attack.
- Pop Point. A position at which the pop-up attack is initiated. The point where climb is initiated.
- Climb Angle. The angle of climb to be achieved following the initiation of the pop-up.
- Pop-to-Pull-Down Distance. Distance from the pop point to the pull-down point. This distance is predictable for a specific set of delivery parameters.
- Pull-Down Point (PDP). A maneuver point where you transition from the climbing to the diving portion of a pop-up delivery.
- Dive Angle. The selected angle of dive for weapons delivery.
- Apex. The highest altitude in the pop-up delivery profile.
- Minimum Attack Perimeter (MAP). An imaginary circle centered on the target equal to the distance from the target at which tracking begins. The radius of this circle varies with planned delivery parameters.
- MAP Distance. Distance from the MAP to the target. Composed of bomb range and horizontal distance covered while tracking.
- Tracking. That portion of the weapons delivery devoted to the final alignment of the aircraft sighting systems with the target.
- Tracking Time. Wings level time from roll out to weapons release.
- Horizontal Tracking Distance. The distance traveled across the ground during the tracking time.
- Vertical Tracking Distance. The vertical distance from the track altitude to the release altitude.
- Aim-off Distance (AOD). The ground distance at 12:00 from the target where you point your nose during tracking.
- Release Altitude. The altitude above the ground at which weapons delivery is accomplished.

#### 5.14.4. Typical Offset Pop-Up

In this maneuver, the pop-up approach course is at an angle from 15° to 90° from the final attack heading. The approach course angle-off varies with the planned climb angle to permit the pilot to acquire the target as soon as possible and maintain visual contact until completion of weapons delivery.

The pop-up is initiated over a preplanned pop point at a minimum airspeed of 450 KCAS, with training restrictions and ordnance loads usually being the limiting factors. The system can help you find the planned pop-up point. The air-to-surface target locator line helps to confirm desired angle-off. The pop point may be coincidental with this ground reference, or adjacent to it.

At the pop point, select desired power (AB or military) make a 3–4 G wings-level pull to the desired climb angle and initiate chaff/flare program. The target should become visible in the front quarter of the canopy slightly off to the side of the planned roll-in direction. After popping you must maintain planned climb angle and monitor altitude gained.

Approaching the preplanned pull-down altitude, make an unloaded roll in the direction of the target. Perform a 3–5 G pull-down to intercept the planned dive angle. Make corrections during the maneuver to compensate for minor errors in the pop point or unexpected winds in the climb to apex at the desired altitude. You normally achieve your planned apex altitude about half way through the pull-down maneuver.

#### 5.14.5. Dive Angles

A critical factor in attaining preplanned parameters is interception of the planned dive angle while pointed at the aim-off point. Minor deviations in attack heading are usually acceptable. As you complete the pull-down, the delivery problems are those of a normal weapons delivery pass (i.e., power modulation, roll out, tracking, weapons delivery and recovery). For computed deliveries, CCIP is probably the optimum delivery mode to minimize exposure time and provide desired ordnance accuracy. DTOS point-blank aiming may also be used. In fact, one technique for a low drag bomb is to pop in DTOS. If you're

wide, you can toss the bombs to the target. At any time, you can change to CCIP by depressing the NWS button.

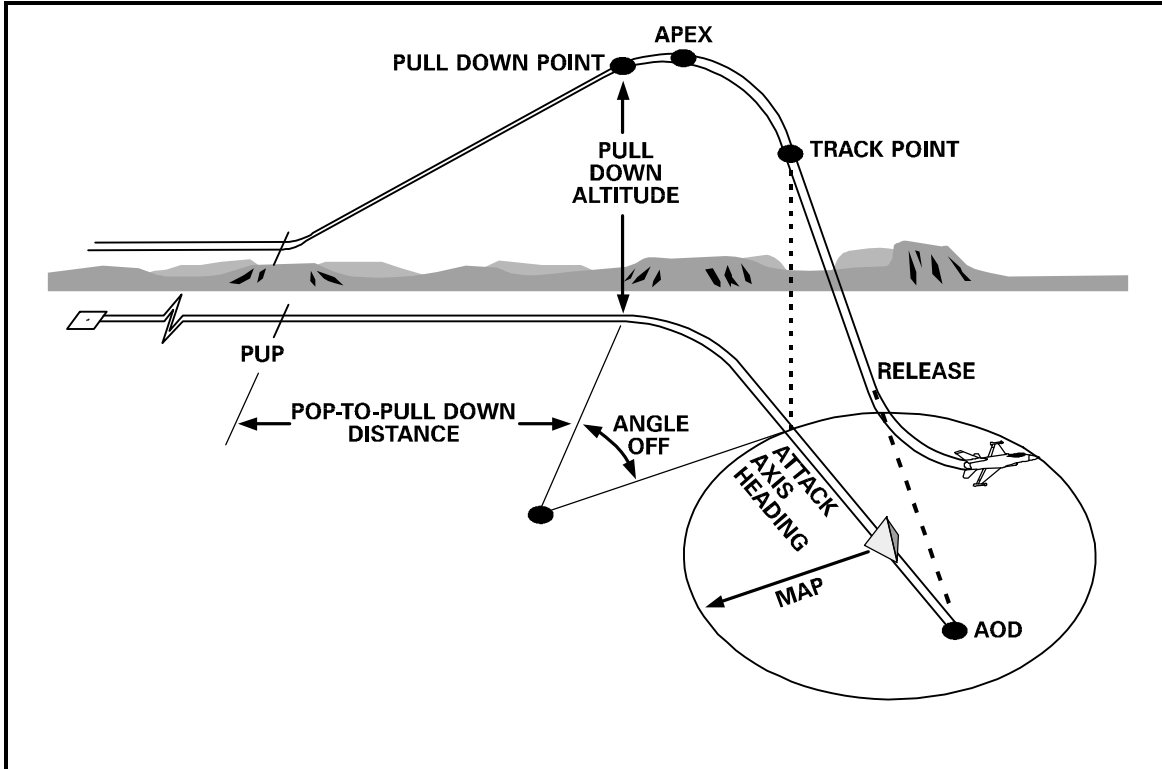


Figure 5.35 Offset Pop-Up Profile

#### 5.14.6. Low Angle Strafe (LAS)

Although the planned angle-off from the target can vary, normally the approach to the target is planned to be  $15^{\circ}$ – $30^{\circ}$  from the desired attack heading at a minimum of 450 KCAS. At the planned pop point, select military power and begin a 3–4 G pull-up to the desired climb angle. This is normally planned to be equal to the planned delivery dive angle plus  $5^{\circ}$ . At the preplanned pull-down altitude, roll the aircraft and begin a pull-down to achieve the desired dive angle. Monitoring the HUD pitch lines in relation to the target will simplify achieving the planned dive angle. Make an unloaded roll out with the CCIP pipper approximately 100' short of the target. After roll out, track and fire just as in a curvilinear/box strafing pass.

#### 5.14.7. Low Angle High Drag Bombing (LAHD) ( $10^{\circ}$ – $15^{\circ}$ )

This attack maneuver is very similar to that of low-angle strafe. It is designed for low-angle delivery of high drag weapons. The approach to the target is normally planned to be made from a run-in heading offset  $15^{\circ}$ – $30^{\circ}$  from the attack heading at a minimum of 450 KCAS. At the desired pop point, a 3–4 G pull-up is initiated to the planned climb angle (usually dive angle plus  $5^{\circ}$ ). At the preplanned pull-down altitude, the aircraft should be rolled towards the target and the nose pulled down to roll out just as you would in any low angle bomb delivery. Normally, this type of delivery is planned to allow 3–5 seconds of tracking/designate time prior to arriving at planned release altitude. For CCIP deliveries, roll out with the target approximately one-third down between the FPM and CCIP pipper. For manual deliveries, roll out with the flight path marker on the correct aim-off point or plan the roll out to place the standby reticle the precomputed number of mils short of the target/upwind aimpoint.

#### 5.14.8. Low Angle Low Drag Bombing (LALD) ( $10^{\circ}$ – $20^{\circ}$ )

The delivery is designed for low-angle delivery of low-drag weapons. Exercise care in computing release altitudes to assure fuze arming and safe escape. Planned angle-off for this type of delivery can

vary from 15°–90°, although optimum angle is approximately 2 x climb angle. Accomplish pull-up to the planned climb angle (15° + 5° and 20° + 10°) and pull-down at the preplanned pull-down altitude. Take care to properly monitor the altimeter to determine the proper pull-down point since the apex altitude for a LALD delivery is considerably higher than for a LAHD delivery and visual cues can be deceiving. For CCIP deliveries roll out with the target approximately halfway between the FPM and CCIP piper. For DTOS, roll out with caged symbology slightly short of the target. Monitor slant range to ensure proper release parameters. Pay special attention to the altimeter to assure you deliver at or above the planned altitude.

#### 5.14.9. High Altitude Dive Bombing (HADB) (30°–45°)

This delivery is designed for high angle delivery of low-drag weapons in a high threat environment. During mission planning, aircraft configuration must be taken into account to ensure this type of approach is feasible, i.e., two wing tanks with six MK 82s may not be an option for high 45° delivery. The approach to the target is normally at 500 KCAS (minimum) to an action point 4–5 NM short of the target. At this point, a check turn between 20°–30° is required to obtain the necessary offset. At the desired pop point, a 4 G pull-up is initiated to the planning climb angle (usually dive angle plus 15°) in full AB. Once the pop-up is established, time should be devoted to target acquisition which can be difficult since you will be looking down over the canopy rail. Monitor the altimeter as the pull down altitude approaches due to the rapid climb rate to ensure correct parameters. At the apex, the aircraft will be at or nearly inverted, so care must be taken to roll out with the proper AOD. Attacks should be planned to provide 5 seconds of tracking/designate time prior to arriving at the release altitude. For CCIP deliveries, roll out with the target approximately two thirds of the way down between the FPM and CCIP piper. For DTOS deliveries, roll out with caged symbology short of the target. For manual deliveries, roll out with the FPM, if available, on the correct AOD. If the FPM is not available, plan to roll out with the proper initial piper placement (IPP) corrected for winds. If the parameters are bad or you have doubts about continuing the pass, either abort the pass or reposition. After releasing weapons, the threat will dictate the type of recovery, but for peacetime training recover with a 4–5 G pull until the nose is above the horizon then execute the egress plan.

#### 5.14.10. Visual Level Delivery (VLD) (0°–5°)

This type of delivery is flown using CCIP when the weather or threat precludes steeper dive angles. Ingress the target area at low altitude, terrain masking and constantly jinking until just prior to weapon release. Since your approach to the target is a random flight path, good planning is required to arrive at an action point where target acquisition is initiated and weapons delivery commenced. If a level delivery is planned, simply arrive at the target on your proper altitude with the CCIP piper properly positioned. If a 5° diving delivery is planned, initiate a 10° pull-up followed by a pull-down/bunt approximately 500' below planned apex. Pay particularly close attention to precise release parameters and to the fuze arming/pull-up anticipation cue to insure adequate fuze arming time-of-fall, fragmentation clearance and ground avoidance. The recovery portion of this delivery must be emphasized to ensure safe escape criteria from your munition—know your dash-34 recovery procedure cold and fly it!

### 5.15. Pop-Up Planning

Precise planning is the key to destroying the target in low altitude pop-up mission deliveries. Planning begins with the fragged target and ordnance load. The target and its environment may drive some attack parameters. For example, a cave at the base of a hill will drastically limit your choice of attack headings. Weather and threat are also significant factors. Similarly, assigned ordnance may determine attack parameters. If you'll have MK 82 LDGP, you must allow yourself enough time to visually acquire a pinpoint target. On the other hand, CBU may require less time on final to fine-tune your aiming. Once you have analyzed target and ordnance related restrictions, you can determine the release parameters.

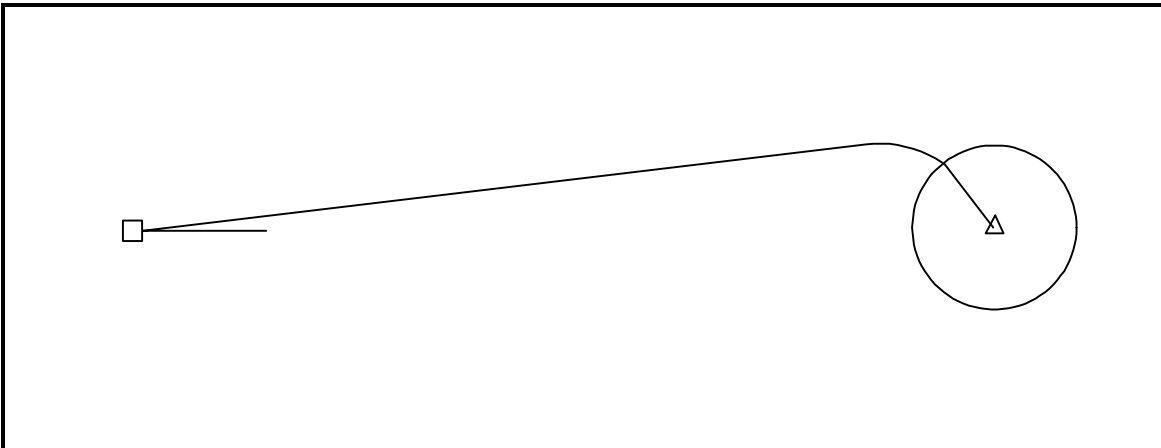
Determine how much time you'll need on final. Normally, 3–5 seconds of wings-level time is enough for most deliveries. Specialized types of ordnance may require you to spend more time on final. Don't try to minimize exposure time to the point that you won't have time to acquire the target. Compute the MAP distance and then go back to the chart and choose a prominent and unique IP that will allow you to get to



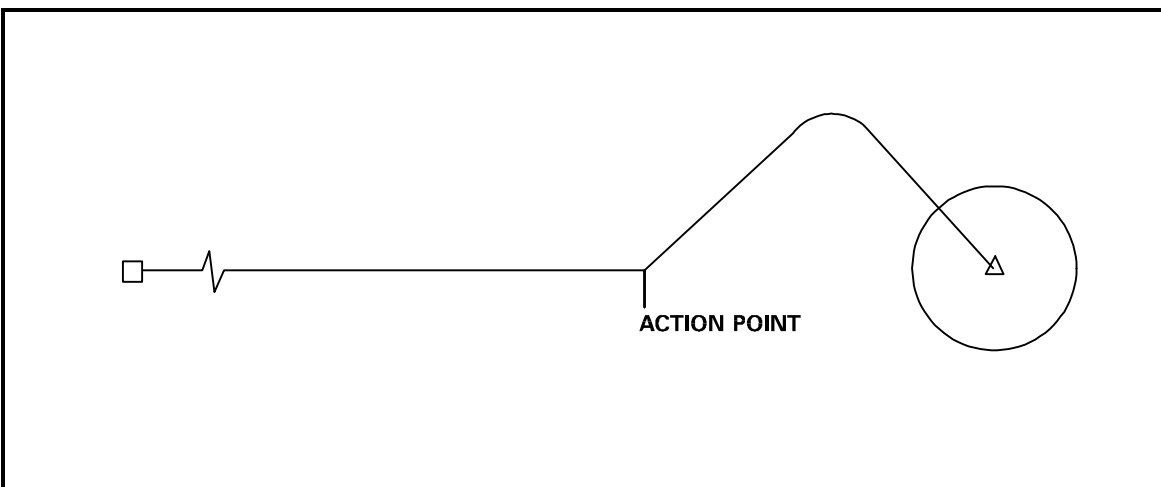
the MAP on an acceptable attack heading. Normally chose an IP 1 to 2 minutes from the target. There are two basic options you can use to get from the IP to the target.

One choice is to fly from the IP directly to the PUP. As Figure 5.36 shows, this approach course will take you to the side of the target.

The other choice is to depart the IP and fly directly at the target. At a given range from the target, turn to the side for offset and then pop up (Figure 5.37). Although it looks more complicated, this choice is often quicker to plan and is the much more common choice among pilots. The reason is that the pop portion of the attack is the same for all IP-to-target distances (assuming the IP-to-target distance is outside the action range). Moreover, at any time, you can put the target on the nose and at the action range, turn a preplanned number of degrees to the side, go a preplanned distance, pop, pull-down, and attack. Consider the high-threat CAS situation where you don't know the target location prior to contacting the FAC. In this case, the simplest way to make a pop-up attack is to depart the IP (if you have one) with the target on the nose and, at a preplanned action range, turn for offset and execute the attack. Over-reliance on the INS could prevent the safe execution of the attack. A faulty INS could cause you to action late resulting in attack parameters well in excess of that planned. Use all available navigation aids to determine the proper action point, i.e., clock, ground reference points, etc.



**Figure 5.36 IP Direct to PUP**

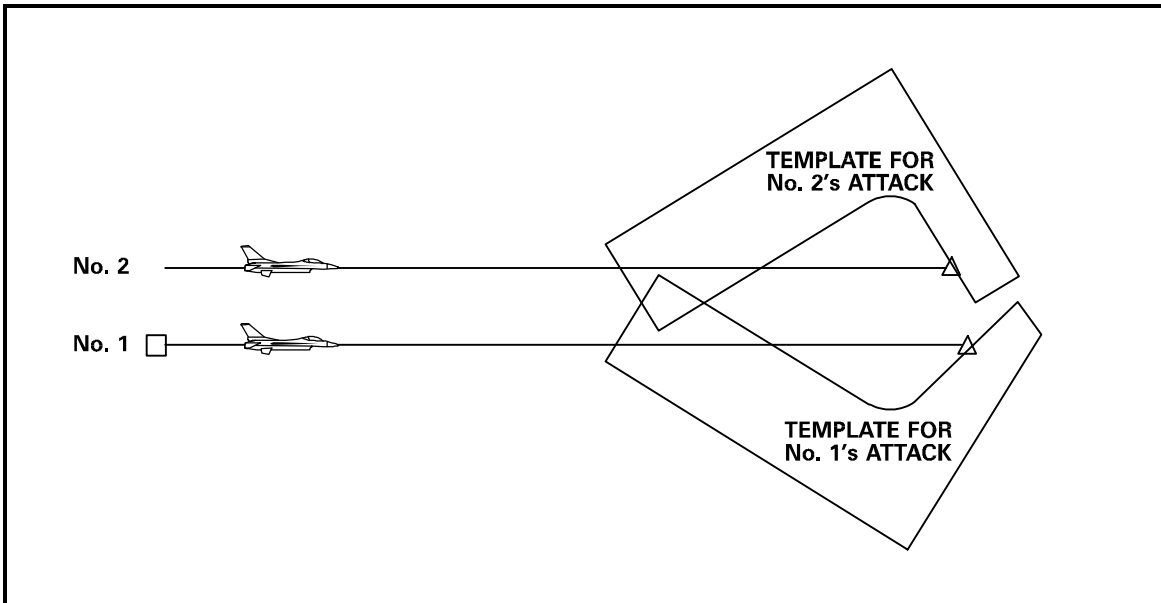


**Figure 5.37 IP Direct to Target**

#### 5.15.1. Planning Element Attacks

When adding a second aircraft to an attack, we encounter complications due to frag and aircraft deconfliction. When multiple aircraft are tasked to attack a target and TOT compression is desired, a

potential flight path and fragmentation conflict exists. The fragmentation problem depends on type of ordnance, delivery profile, and number of aircraft attacking the target. Deconfliction can be achieved through time, altitude, lateral separation of aimpoints (Figure 5.38), distance separation from target, or a combination of each. For actual data refer to T.O. F-16-34-1-1.



**Figure 5.38 Simultaneous Attacks**

First, let's look at the maximum bomb fragmentation travel chart in Table 5.3. This data must be used to determine fragment deconfliction between multiple aircraft attacks. The envelopes present the maximum altitude and maximum horizontal range anticipated for the worst-case fragment of the bomb case, and the time from detonation until all bomb case fragments have settled to the ground. Data are provided for sea level and 5000' target density altitudes. Interpolation between sea level and 5000' and extrapolation up to 10,000' are permissible.

#### 5.15.1.1. Time Deconfliction

Time separation between aircraft deliveries must be equal to or greater than the time the preceding weapon's fragments are in the air, plus the delivery TOF of the preceding munition. To ensure frag deconfliction from the last weapon in the string, attack intervals should include the time required for the ripple/train release.

The classic method to achieve time separation is to space the aircraft in elements 4 to 5 nm in trail. Line abreast to a trail formation of 4-5 nm can be accomplished quickly using variations of a 90/90 maneuver:

- The wingman turns 90° off the ingress heading for approximately 20 seconds.
- After 20 seconds, the flight leader should have traveled 5 nm and the wingman then turns back to the target.
- Some visual contact may be lost; initiate close to the target but far enough out to avoid getting jammed.

Advantages:

- A more flexible attack is possible if navigation accuracy or target acquisition is questionable.
- Subsequent flight members can bomb off of lead's bomb impact.

Disadvantages:

- The wingman flies single-ship close to the target area.
- The flight strings out, which reduces visual mutual support and complicates post-attack rejoin.

- Too much turning near the terminal threat area.
- Disorienting to the wingman requiring a 90° turn to the target.

#### 5.15.1.2. Altitude Deconfliction

Following aircraft must recover above the maximum altitude for the fragment envelope for the preceding attacker's munition. For example, a 3150' minimum recovery altitude is required for a MK 84 delivery at a 5000' target density altitude (Table 5.3).

Advantages:

- The wingman will have more time to acquire the target.
- High release enables a direct, radar-fuzed CBU delivery.
- Weapon effects improve with increased impact angle.
- Allows simultaneous attacks on a point target.

Disadvantages:

- Weather must permit higher-altitude deliveries.
- Exposure time for wingmen is increased.
- Depending on release altitude, puts wingman in the heart of threat envelopes.

<b>MAXIMUM BOMB FRAGMENT TRAVEL</b>						
MUNITION	ALTITUDE (FEET) TDA		HORIZONTAL RANGE (FEET) TDA		TIME OF FLIGHT (SECONDS) TDA	
	SEA LEVEL	5000'	SEA LEVEL	5000'	SEA LEVEL	5000'
<b>UNITARY WARHEADS</b>						
MK-82 All Types	2140	2500	2550	2900	24.4	25.9
MK-84 All Types	2770	3150	3260	3715	28.0	29.7
BLU-109 All Types	3465	3915	4230	4795	30.3	32.1
<b>INTACT CLUSTERS</b>						
MK-20 Rockeye	1380	1575	1645	1850	19.4	20.6
CBU-24B/B; CBU-49B/B; CBU-52B/B; CBU-58/B, A/B; CBU-71/B, A/B	1895	2140	2290	2595	23.0	24.4
CBU-87/B	1895	2140	2290	2595	23.0	24.4
CBU-89/B	2340	2655	2780	3165	26.2	27.6
<b>CLUSTER SUBMUNITIONS</b>						
BLU-26/B (CBU-24B/B) BLU-59/B (CBU-49B/B)	960	1085	1160	1310	16.3	17.3
BLU-61A/B (CBU-52B/B)	665	755	775	880	14.2	15.0
BLU-63/B, A/B (CBU-58/B, A/B) BLU-86/B, A/B (CBU-71/B, A/B)	430	490	490	560	11.6	12.3
BLU-118 (MK-20 Rockeye)	695	790	800	915	14.7	15.5
BLU-97/B (CBU-87/B)	545	620	635	725	12.8	13.7

**WARNING:** The data in this table is for illustration only and should **not** be used for actual mission planning. Ref 1M-34 for current data.

### **Table 5.3 Maximum Bomb Fragment Travel**

#### 5.15.1.3. Horizontal Deconfliction

Based on data from the same chart, targets separated by a lateral distance of more than 3715' (TDA 5000') are clear of the frag envelope. This means that no portion of the delivery/recovery by succeeding aircraft should be closer to the target than the 3715' minimum (Figure 5.38). If attack headings are not parallel, more lateral spacing between targets is required.

Advantages:

- Visual contact is maintained throughout.
- Simultaneous attack saturates defenses.
- Reduces flight exposure time.
- Disadvantages:
- Large target is required.
- Flight path conflict over the target is possible.

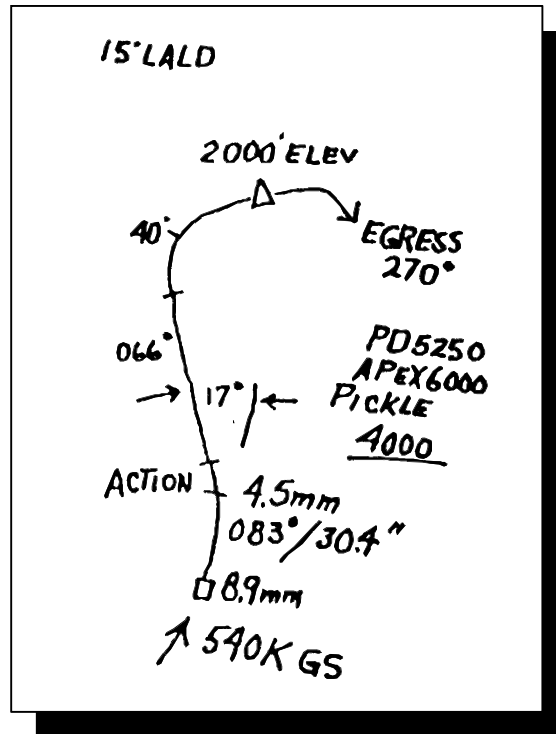
#### 5.15.1.4. Aircraft Deconfliction

Depending on target separation, planning for the attack must deconflict aircraft within the attacking element. Types of deconfliction include time, altitude, and horizontal as mentioned above plus attack geometry.

- The direct IP-to-target pop-up planning approach must be modified for a wingman who's in tactical formation.
- The flight leader must plan the attack so each pilot regains mutual support after the attack while egressing the target area as fast as possible.

### **5.16. Flying A Tactical Pop-Up**

Whether you'll be a leader or wingman, there are three things you can do that will greatly improve your chances of success: know the profile, navigate precisely, and recognize and correct for errors. It helps to have a sketch of the attack on your leg (Figure 5.39).



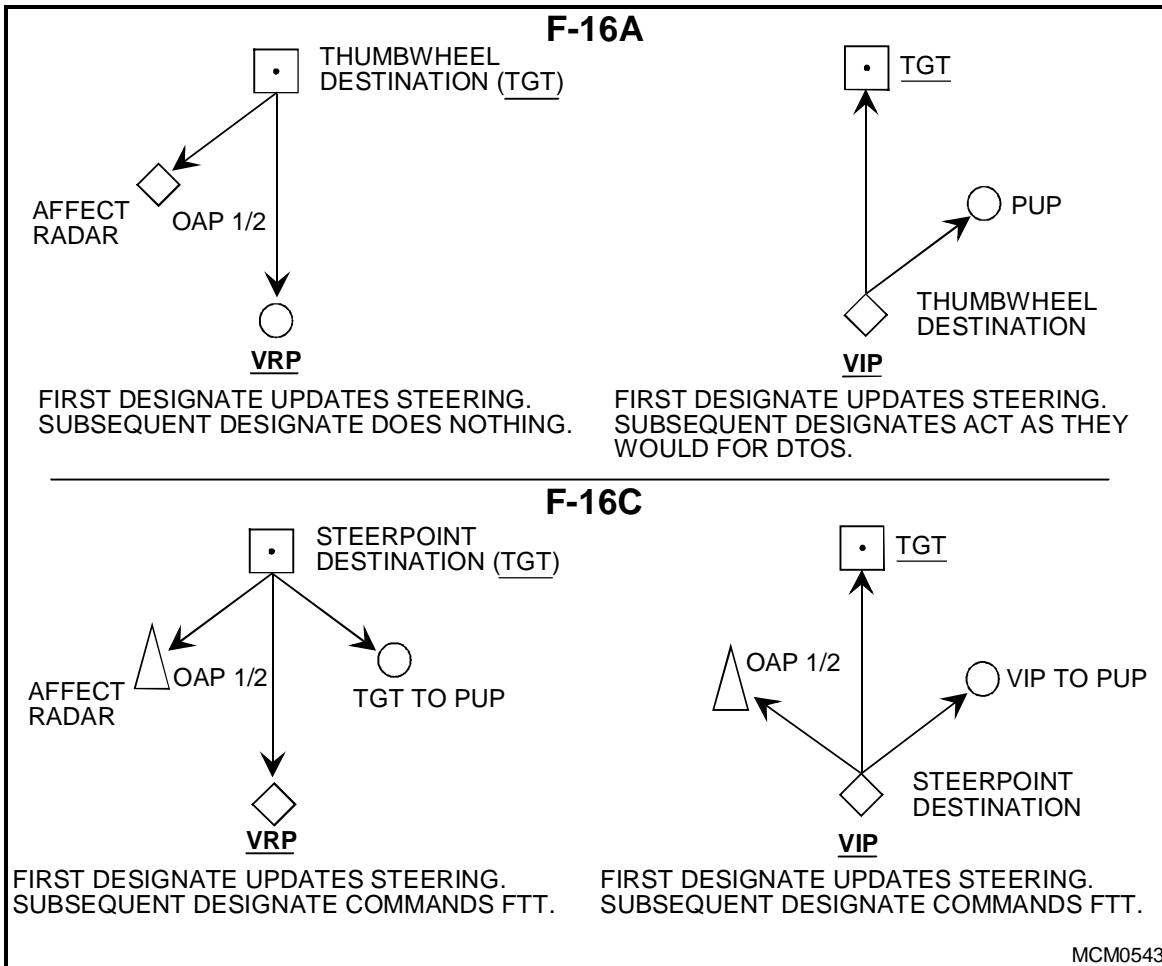
**Figure 5.39 Attack Profile Sketch**

Navigate precisely and be on speed before the IP. Choose an IP you can easily find and use all available cues to position yourself exactly over it. Use F-16 avionics to improve situational awareness. There are few things worse than to have a threat divert your attention during an IP-to-target run and then try to determine just where you were in the attack. While DR is still important, there are few minds faster than the FCC in determining the what, where, and when of target information. The FCC can significantly enhance situational awareness by providing accurate target location. You must, however, know what to load, what help is available, and where to look for it. An understanding of avionics updating is important to fully use the F-16 avionics. Block 40/50 series enjoy a great advantage with GPS. However, a frequent cross-check of NAV/GPS status as well as a thorough understanding of the KALMAN filter are required.

For VRP, load the target in a steerpoint or thumbwheel. You may load two offsets to use with the radar or to use as HUD references to get to the pop-up point. In the F-16C designate the appropriate steerpoint as the target. One pop-up point can be loaded.

For VIP, load the IP in a steerpoint or thumbwheel. In VIP mode, OAP 1/2 won't affect radar operation but you can use offsets to give you a HUD symbol, a 6 mil circle over the pop point. OAPs will affect cursor position in the F-16C.

Notice the similarity between VRP and VIP (Figure 5.40). Both use bearings between IP and target and can provide a HUD symbol to help you find the pop point. Note that the bearing is true, not magnetic. If you haven't zeroed the variation, the bearing you load in the INS will probably not be the final attack heading you'll fly on your HSI or HUD. In addition, both use identical methods to update geometry: slew and/or DESIG when directly over the IP/RP. Anytime during the attack, you can switch to CCIP by depressing the NWS button.



**Figure 5.40 VRP/VIP**

A slew update of the VRP/VIP point over the RP/IP as opposed to a designate update provides flexibility to the pilot. The pilot can select an air-to-air radar mode "hands on" without losing the VRP/VIP update. If a designate update is done at the VRP/VIP point, then selecting an air-to-air mode will dump the update out of the FCC memory. There are differences:

- In VRP, the target is the selected steerpoint/thumbwheel and in VIP it's the IP.
- (F-16C) VRP/VIP are not weapon delivery modes. They are sighting options used with CCRP and LADD. The radar is commanded to GM or STBY dependent on programming. With the first designate, you update geometry. At the second, you command fixed target track since the sensor of interest has moved to the radar after the first designate. In VIP, you will have HUD steering/digital range to the target and HSI bearing and range to the IP.
- (F-16A) VRP only is not an SCP weapon delivery mode. It is used with CCRP and LADD. VIP is an SCP mode. With the first designate in VIP, you update geometry. The second designate commands symbology exactly like DTOS. In VIP you will have digital range and bearing to the target.

#### 5.16.1. Camouflage, Concealment, and Deception (CCD) Considerations

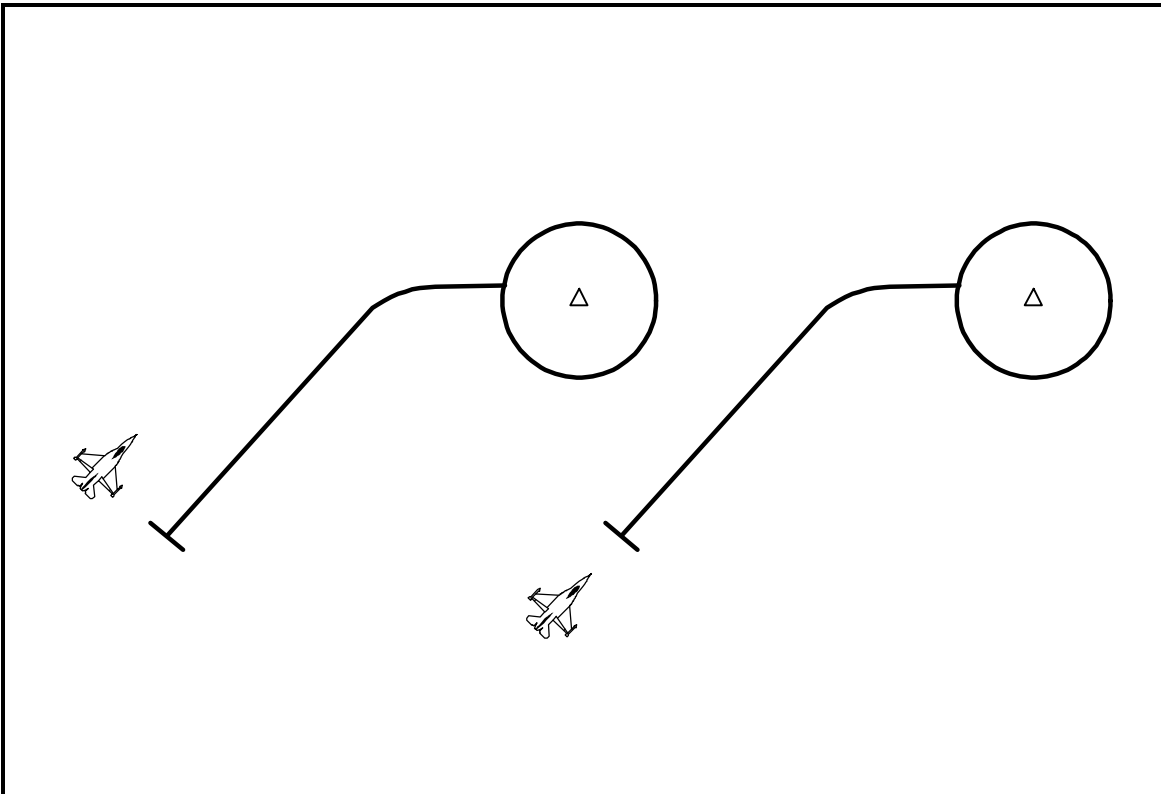
Potential adversaries have the capability of using camouflage, concealment and deception techniques to apparently relocate visual IP's and DMPI's. If your INS appears to be performing well, and you have confidence in your IP and target coordinates, you should carefully study INS designated IP's and DMPI's for tone-down or false target insertions. Redesignating on false targets would cause you to miss the target; updating the INS on a falsified IP would degrade an otherwise accurate navigation system.

### 5.16.2. Recognize and Correct for Errors

There are any number of factors that could possibly prevent accurate positioning at the pull-up point. A few are poor navigation and reactions to enemy defenses. In any case, if you don't get to the proper pull-up point, three things must happen. First, you must recognize that you are not at the preplanned parameters. Second, assess whether you have sufficient turning room to complete the attack by repositioning from your present position. Third, you must properly execute a re-attack option, or abort the attack. The key to successful repositioning lies in early recognition of deviations from preplanned parameters. Two broad categories of errors exist in positioning relative to planned pop point and approach course— those that put you outside planned parameters and those that put you inside them. If you find yourself in this situation, consideration should be given to aborting the attack and descending back to low altitude as quickly as possible. Once back at low altitude, then assess the tactical situation and either egress or reattack. However, if conditions permit (low threat, weather, and situational awareness), a repositioning maneuver may allow you to still put bombs on target in the following situations:

#### 5.16.2.1. Pop-up Outside of Planned Parameters

If you pop up and find that you are outside the preplanned parameters, you could be either outside the planned run-in line, or short of the planned pop point (Figure 5.41).



**Figure 5.41 Outside Pop-Up Parameters**

If you are outside the planned run-in line you have the following repositioning options available (listed in order of preference):

- Angle in toward the roll-in point during the pull-up.
- Apex at a higher altitude to make good the preplanned dive angle, accepting additional tracking time.
- Apex at the preplanned altitude, and making the last part of the turn to final fairly level and ease off the G as in a curvilinear pass.

If you have popped and subsequently find that your actual pop point was short of the planned pop point you can:

- Reduce G and climb to arrive at the preplanned roll-in point.
  - Apex at a higher altitude to make good preplanned dive angle and accept a new axis of attack.
- Both these options increase exposure time. Tactical considerations will likely determine the course of action you take. In tactical scenarios, anytime you are faced with additional time, make every effort to be unpredictable. Fly a curvilinear repositioning maneuver.

#### 5.16.2.2. Pop-up Inside Planned Parameters

If you pop-up and determine that you are inside planned parameters, you could be either inside the planned run-in line or past the pop point (Figure 5.42).

**WARNING:** These two situations are more difficult to compensate for, require earlier recognition, and are potentially far more dangerous than the previously discussed errors.

If you are inside the planned run-in line, you can pull back towards the planned run-in line and intercept it prior to the roll-in point (Figure 5.43). This is possible if you recognize the error early.

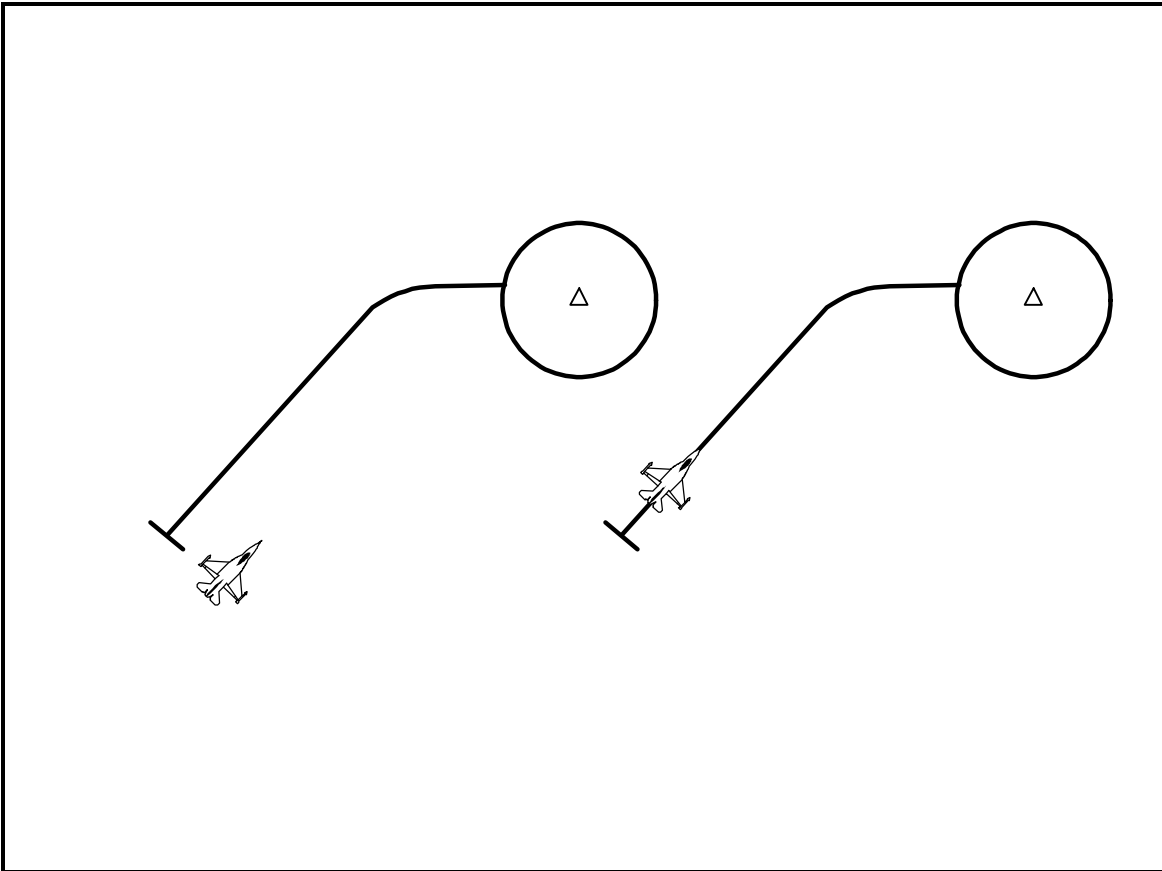
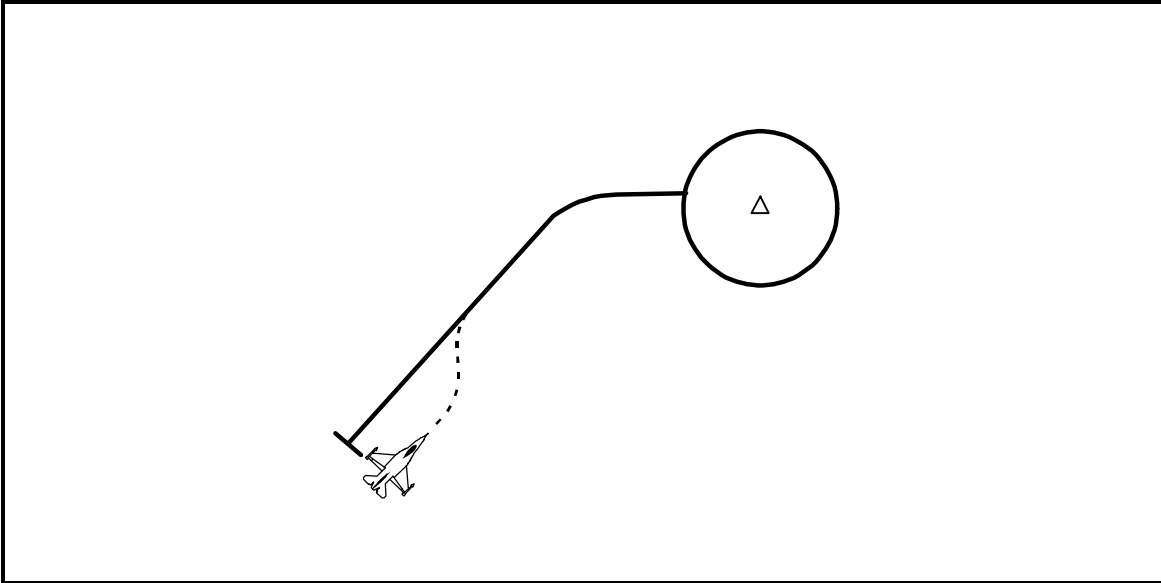


Figure 5.42 Inside Pop-Up Parameters



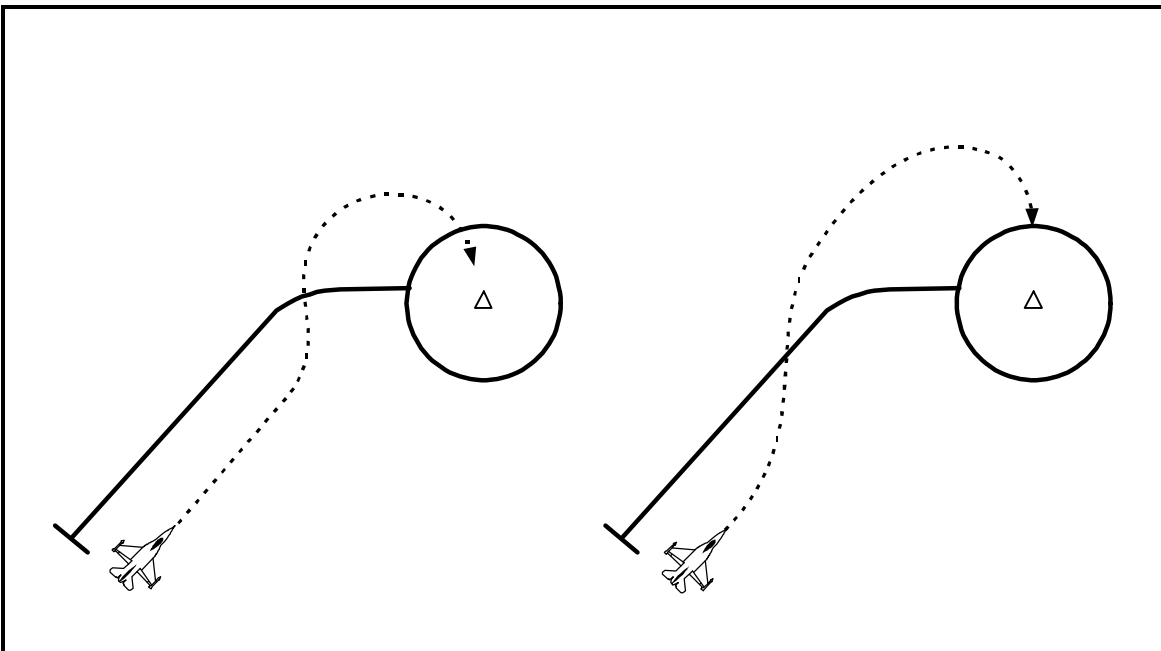


**Figure 5.43 Intercepting the Run-In Line**

If you find that the track point will occur inside the MAP, ABORT (Figure 5.44).

If you attempt to fly the maneuver on the left, you will find yourself rolling out pointed at the AOD well inside the MAP, and be excessively steep if you went to the planned apex altitude. The example on the right depicts a flight path that is outside the planned line, giving us enough turning room to achieve the MAP but creating an indirect pop-up situation.

How do you know you are inside the pop point? A preplanned ground reference point would be one way to tell. Another more common way is to look for the classic picture you have seen previously. The relationship of the target on your canopy is another indicator. For low angle-off attacks ( $15^{\circ}$  to  $60^{\circ}$ ), the target should not be any further aft than 10:30 or 1:30. For higher angle-off attacks ( $60^{\circ}$ – $90^{\circ}$ ), the target should not be any further aft than 9:30 or 2:30. In most cases the target should not be hidden by the canopy rail.



**Figure 5.44 Track Point Inside MAP**

### 5.17. Pop-up Formulas

There are two methods to complete pop-up planning. One choice is to use the formulas below to determine pop up parameters. The other is to use the ACC F-16 Weapons Delivery Program which should be available on your squadron weapons computer. Refer to Figure 5.45 for a diagram and definitions. The following formulas may be used (all altitudes are in feet AGL):

Horizontal tracking distance =  $GS \times 1.69 \times \text{tracking time}$ . Where,  $GS$  (zero wind) =  $TAS \times \cos$  (dive angle).

Vertical tracking distance =  $TAS \times 1.69 \times \text{track time} \times \sin$  (dive angle).

MAP distance = bomb range + horizontal tracking distance.

Track altitude = pickle altitude + vertical tracking distance.

AOD = (release Alt) / (tan (dive angle)) – bomb range.

Horizontal turn radius =  $V^2 / (GR \times g) = (TAS \times 1.69)^2 / (GR \times 32.2)$

$g = 32.2$  and  $GR = \text{cockpit } G$ .

Climb angle = dive angle +  $5^\circ$  for dive angles  $\leq 15^\circ$

Climb angle = dive angle +  $10^\circ$  for dive angles  $> 15^\circ$ .

Angle off =  $2 \times \text{climb angle}$

Apex altitude. For 3-3.5 G pull-down.

Apex Alt = track altitude + (dive angle  $\times 50$ )

Apex altitude. For 4.5-5 G pull down.

Apex Alt = track altitude + (dive angle  $\times 37.5$ )

Pull-down altitude. For 3–3.5 G pull-down.

Pull-down alt = apex alt – (climb angle  $\times 50$ )

Pull-down altitude. For 4.5–5 G pull down.

Pull-down alt = apex alt – (climb angle  $\times 37.5$ )

Pop to pull down dist = Apex Alt ("AGL")  $\times 60 / \text{climb angle}$

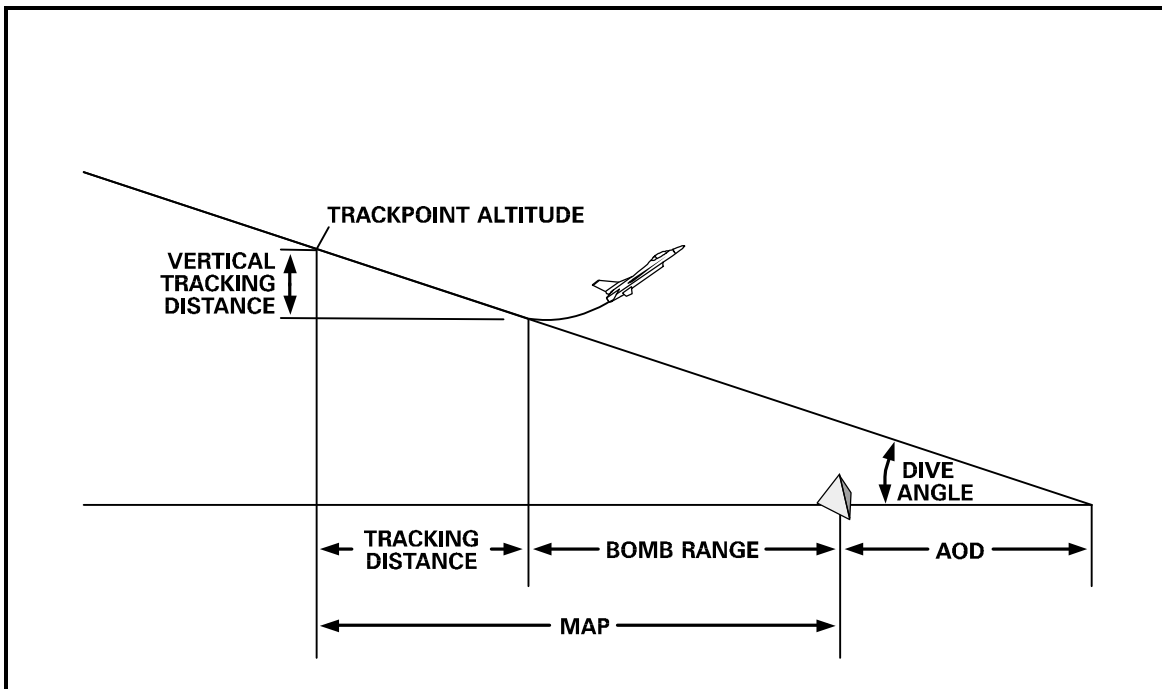


Figure 5.45 Pop-Up Computations

### 5.17.1. Sample Pop-Up Computation

Givens:

- Target: Tank maintenance complex.
- Ordnance: 6 x MK82 LDGP with M904E2 fuzes set at 4.0 seconds.
- Threat: Will force a pop-up attack but will not affect run-in or attack headings.
- Weather: 4000 scattered and 4 miles visibility.

**CONCLUSION:** Make a 15° LALD pop-up attack dropping six single bombs at 50' intervals. No run-in heading restrictions (Figure 5.45).

Release parameters. (From TO 1F-16-34-1-2 Ballistics Tables):

- Dive angle: 15°
- Release altitude: 2000'
- Release speed: 520 KTAS
- Release range to center of stick: 5138'
- Stick length: 122'
- Time on final. 5 seconds.
- MAP distance = bomb range + tracking distance.
- Bomb range = 5138' (from the -34-1-2).
- Tracking distance = 1.69 x ground speed x tracking time.

The Dash 34-1 tells us that 520 KTAS in a 15° dive with no winds equates to about 500 knots GS. This chart is equivalent to the following equation:

- Ground speed = TAS x cos (dive angle) = 520 x cos (15°) = 502 knots
- Tracking distance = 1.69 x 502 x 5 = 4242'
- MAP distance = 5138 + 4242 = 9380'

In this problem, in order to track the target for 5 seconds and then pickle at 2000' AGL, you must arrive at a point 9380' from the target with your nose on the aim-off point. We can also get some other useful information from the Dash 34:

- AOD = (release altitude / tan (dive angle)) – bomb range = 2000 / tan (15°) – 5138 = 2326'
- Vertical tracking distance = 520 x sin (15°) x 1.69 x 5 = 1137'

Now, choose the angle-off and IP. Smaller angles-off will reduce exposure time but make the pop point more critical and repositioning more difficult. Experience has shown that as the dive angle increases, the angle-off also needs to increase to allow the pilot enough time to fly the pull-down and acquire the target. As a general guide, use the following formula to determine angle-off:

- Angle-off = 2 x climb angle
- For dive angles of 15° or less, the climb angle should be dive angle plus 5°.
- Angle-off = 2 x (15° + 5°) = 40°

While we're still in a numbers mode, we can use some other rules of thumb to calculate more required information: pop-to-pull-down distance, apex altitude, pull-down altitude. Actually, you have a choice of two sets of rules of thumb to use to derive some of this information depending on the G you want to use in the pop-up maneuver. One set of rules applies for 3.0–3.5 G maneuvering and a second set is for 4.5–5.0 G's. In this problem, we'll use the rules for the lesser. We made this choice for two reasons: to preserve energy and loosen the maneuver slightly to allow for error corrections. You may want to increase maneuvering as well as decrease the tracking time to make a tighter maneuver thus offering less threat exposure.

- Track point alt. = pickle alt. + vertical tracking distance = 2000' + 1137' = 3137'
- For 3-3.5 G roll-in: Apex alt = track point alt. + (dive angle x 50)

- Apex alt. =  $3137' + (15 \times 50) = 3137 + 750 = 3887' = \text{Approximately } 3900'$
- Pull-down altitude = Apex alt. - (climb angle x 50) =  $3,900 - (20 \times 50) = 2,900'$
- Pop-to-pull-down distance = (Apex Alt. (AGL) x 60) / Climb Angle =  $3900 \times 60 / 2 = 11,700'$
- Turn radius =  $(KTAS \times 1.69)^2 / (g \times GR) = (520 \times 1.69)^2 / (32.2 \times 3.5) = 6853'$
- $g = 32.2 \text{ fps}^2$  and GR = cockpit G

With no restrictions on attack heading, we're free to choose the best IP available and then determine the approach heading that will give precisely the angle-off you're looking for, normally, twice the dive angle. But, as mentioned earlier, when you fly directly from the IP to PUP, the offset angle changes when the IP-to-target distance changes (Figure 5.46). If you change the IP you may have some replanning to do. Further, it means that the planning for this 15° LALD attack, a very common attack, is only good for one unique IP-to-target distance. So, let's fix the offset angle by turning for offset at a constant distance from the target regardless of the IP-to-target distance (Figure 5.47). This way, the same pop-up planning can be used even if you must change IPs. In addition, you can use the same attack plan against other targets, i.e., create a library of pop-up profiles. Here, we'll use a point 4.5 NM short of the target to take our offset.

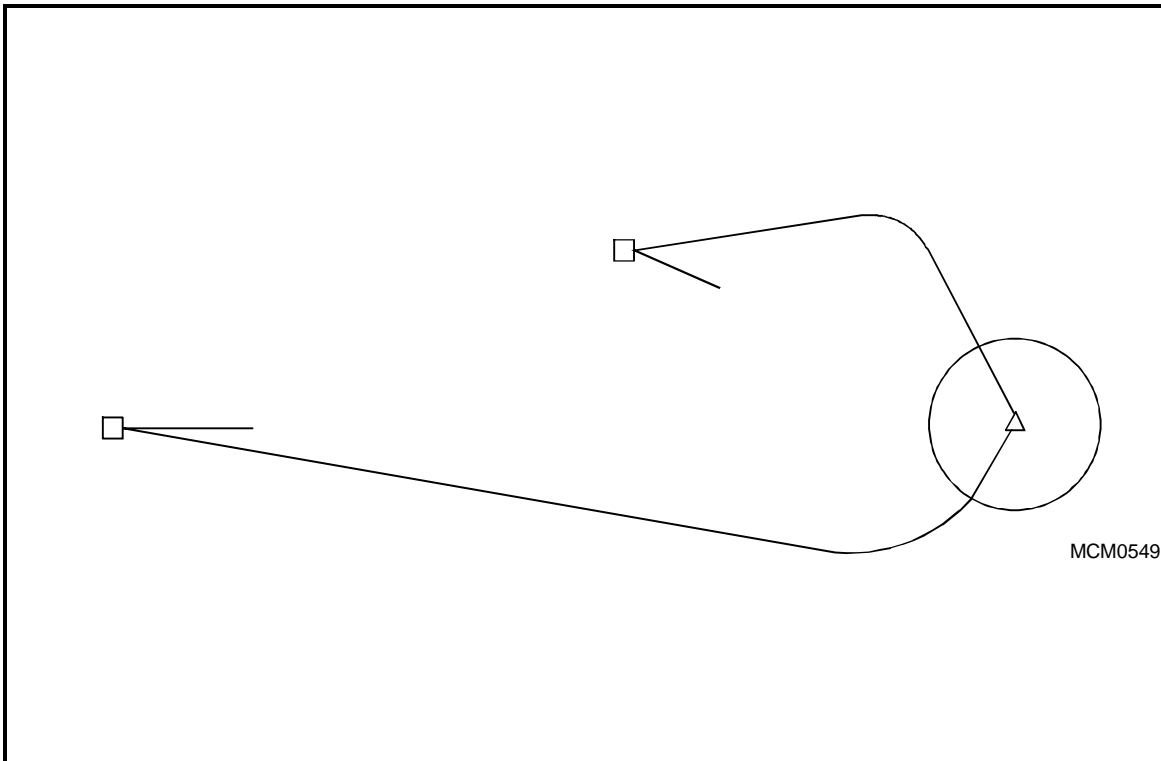


Figure 5.46 Offset Angle Changing

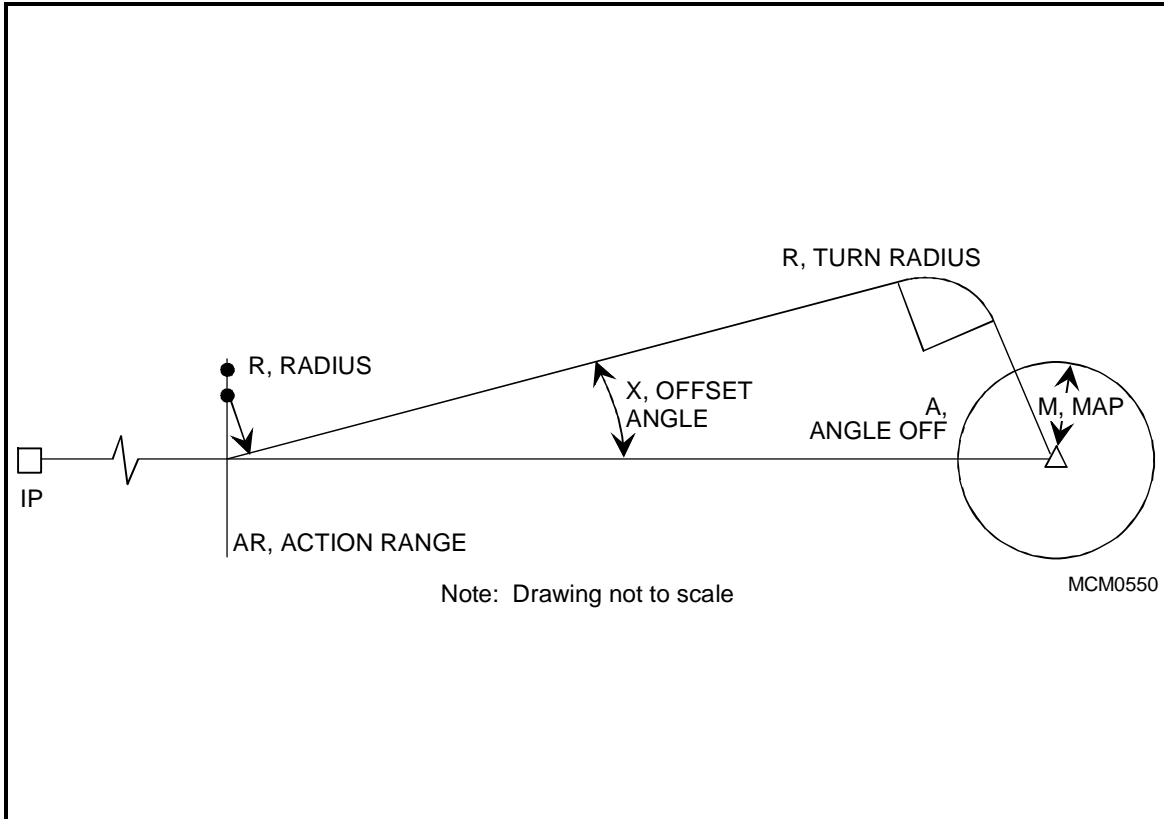


Figure 5.47 Offset Turn at Constant Distance

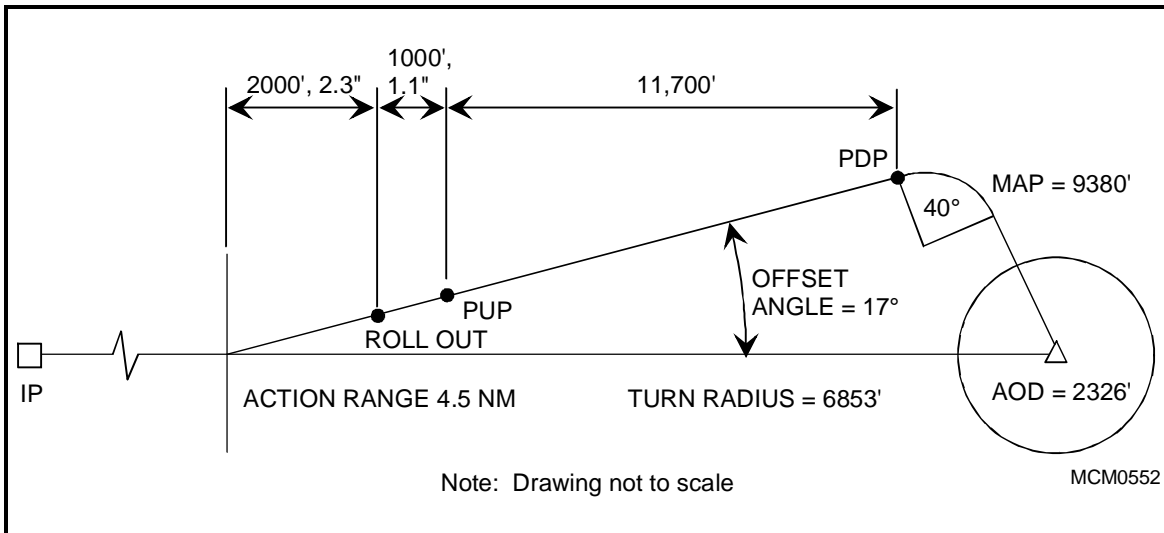


Figure 5.48 Completed Attack Computations

Now that we have defined the action point, angle off, turn radius, and pop up to pull down distance, we can draw the attack ground track on the chart as illustrated in Figure 5.48. The offset angle can be measured as the difference between the IP to target run in heading and the action heading. Our example in Figure 5.48 resulted in a 17° check turn at the action point. The action-to-rollout distance can also be measured as the distance between the action point and the point at which you rollout pointed at the pull up point and reflects a constant 3-3.5 G turn. This distance is measured at 2000' in our example.

The pull-up point is 11,700' prior to the pull down point as computed from the pop-to-pull-down formula. Measure the distance between the action point rollout and pull up point. In our example, this equates to 1,000' and requires 1.1 seconds hold-down time prior to pop up.  $1000 / (520 \times 1.69) = 1.1$

The squadron weapons shop will have a program on the weapons/flight planning computer that will quickly compute the majority of the pop up parameters.

We still need to draw the attack to scale so we can do some map study and this step brings us to the second alternative for determining attack information, graphics. You can draw the attack directly on your map, but it's better to make a template out of a piece of paper or light cardboard. You can then use the template to adjust the attack profile and finally trace it on your map. In addition, you can add the template to your library of attack options. To make a template, you must decide on a scale. We suggest 1:50,000 for two reasons: 1) if you're going to derive headings and distances graphically, you need a scale large enough for accuracy and 2) You can trace the profile on a 1:50,000 scale-map, the type map commonly used in attack planning. You'll need some paper/light cardboard, a plotter and a compass or circle template (if you want round circles). Draw the following in order (Figure 5.49):

- MAP.
- Attack course.
- Pull-down turn.
- Approach course at desired angle-off.
- PUP on approach course.
- Desired action range.

Then:

- Cut along the ground track.
- Lay the template on your map with the approach course intersecting the direct IP-to-target course line at the desired action range, or at the IP, if you prefer.
- Trace the attack profile and, if you haven't computed the offset angle and distances earlier, measure them now.
- Note prominent terrain or cultural features along the profile.
- Save the template!

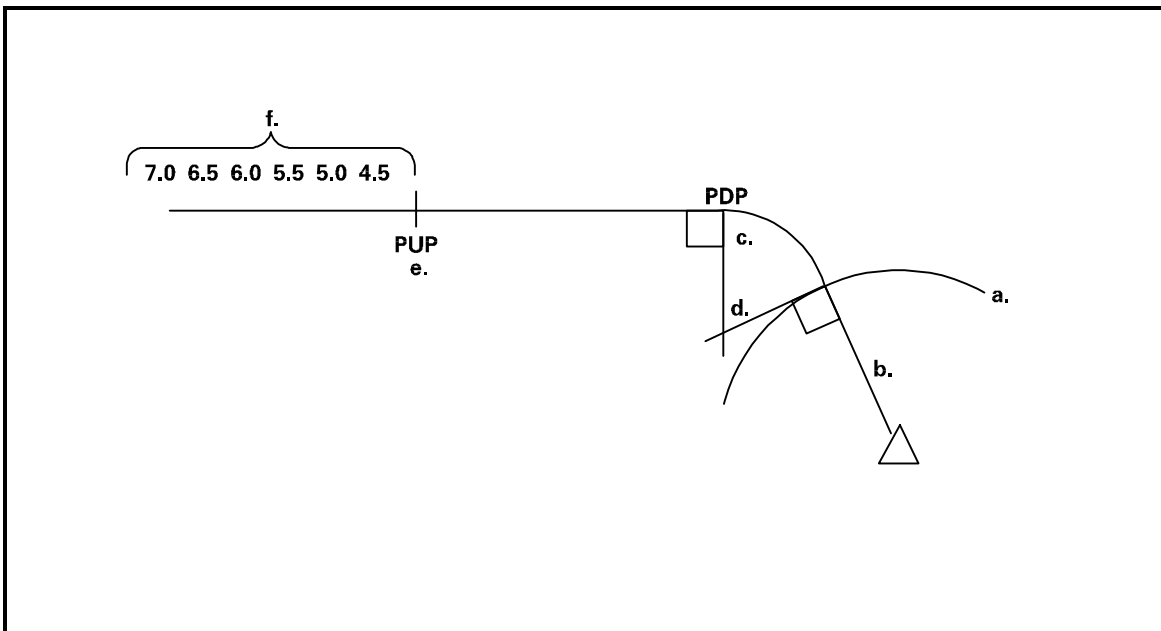
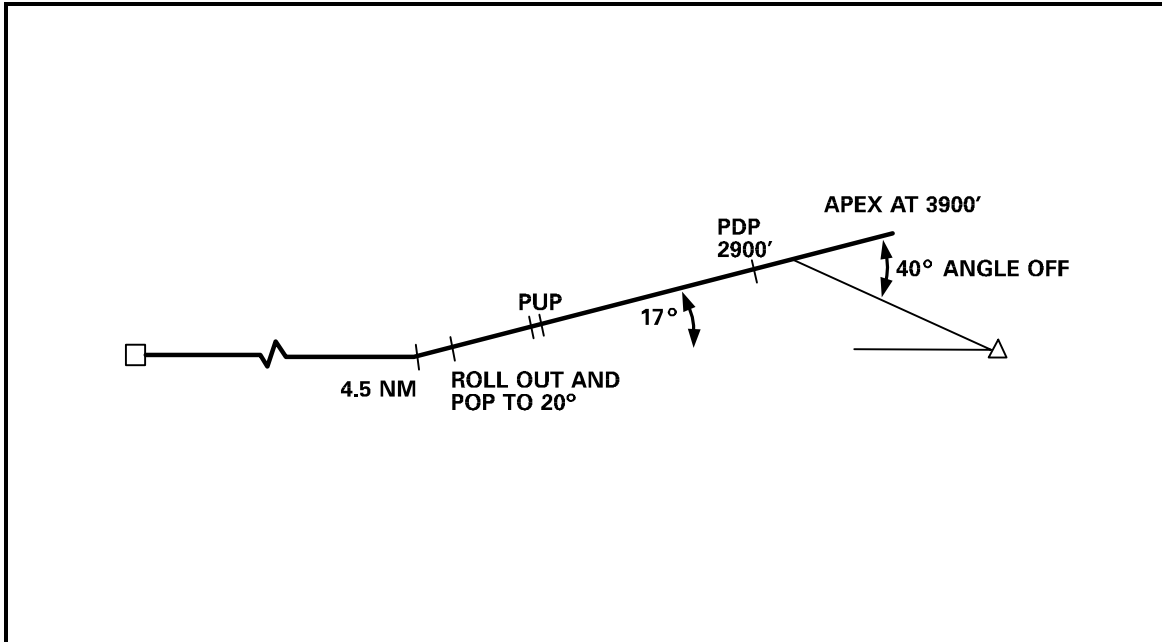


Figure 5.49 Template Construction

In this example, we've walked through pop-up calculations to plan the following attack (Figure 5.50):

- Dive angle: 15°
- Rel Alt: 2000'
- Approach and Rel airspeed: 520 KTAS/500 KCAS
- Time on final = 5 seconds
- AOD = 2326'



**Figure 5.50 Attack Example**

Attack description:

- Put target on the nose.
- At 4.5 NM take 17° offset with 3.5 G turn.
- Roll out and immediately pull up to a 20° climb.
- At 2900' AGL, roll towards target.
- Pull down with 3–3.5 G's. The heading change should be approximately 40°.
- Roll out at 3137' in 15° dive with the FPM 2326' beyond target.
- Pickle at 2000'.

### 5.18. Flyup Attacks

Flyup attacks are a derivative of the pop-up attack and are primarily used in the low threat environment where AAA, small arms, and IR SAMs are the only threats in the target area. Ingress is at low altitude due to en route threat or to effect tactical surprise. The flyup is initiated 6 to 8 NM from the target where both the wingman and leader begin an aggressive pull up to the base altitude of the planned delivery. Once at base altitude, the delivery is a curvilinear delivery with emphasis placed on recovery above the AAA/small arms envelope. Emphasis must be on element mutual support and accurate weapons delivery.

- The flight should use radars to sanitize the target area for airborne threats prior to the fly-up.
- Fly-up at 6–8 NM from the target. The flight lead will check 10°–20° away from the target and initiate a climb (use burner if necessary) to arrive at base altitude in a position to execute a high angle delivery.

- When lead executes the fly-up, the wingman's primary job is visual lookout. Fly-up to place yourself in a position to visually support lead and execute the planned attack.

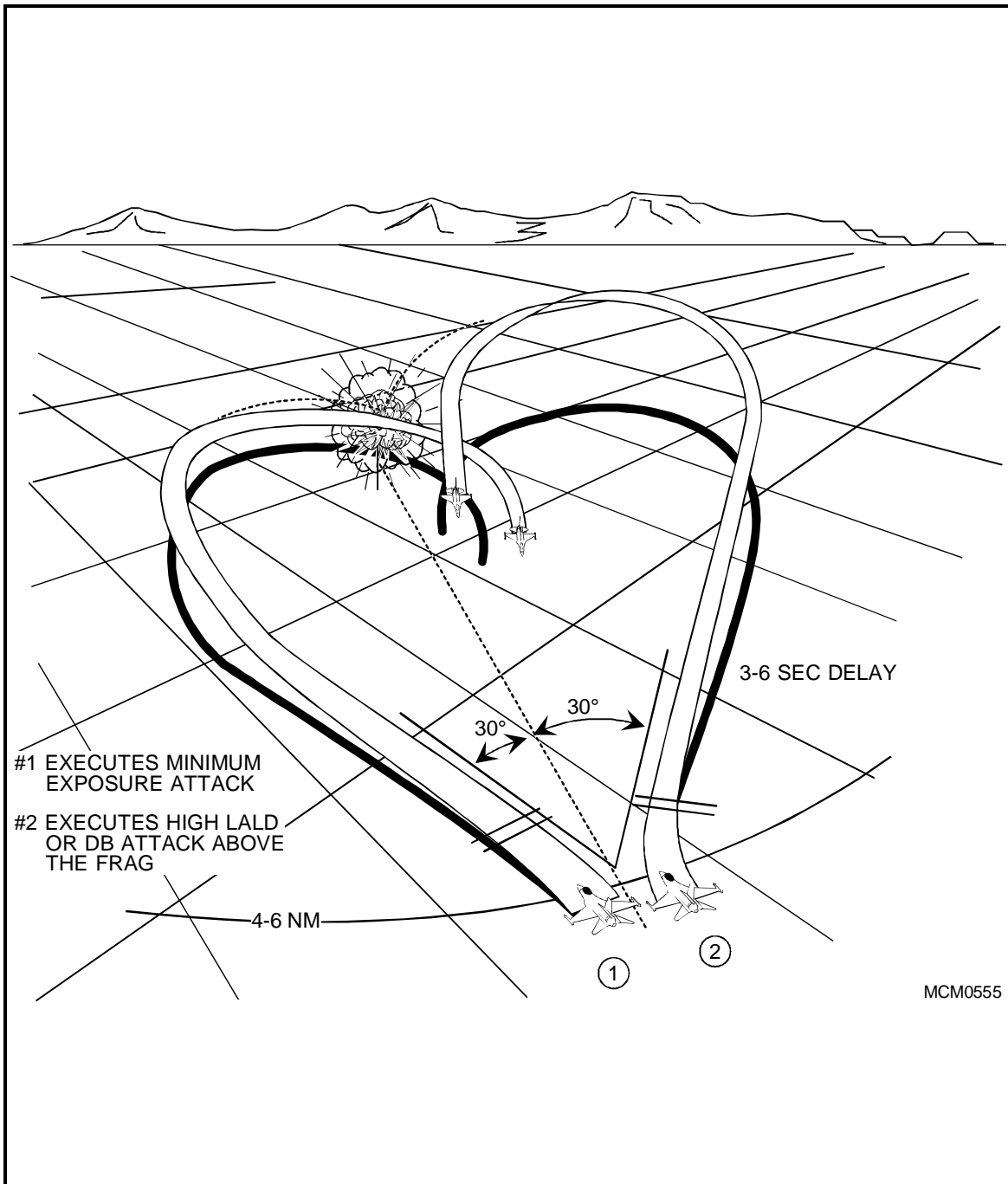
### 5.19. Two Ship Employment Considerations

Deconfliction methods can include split, echelon, trail, shooter cover, and loft.

#### 5.19.1. Split Pop Attack

This option is designed for minimum exposure while splitting the defenses. Deconfliction can be achieved through altitude, distance, or timing. To achieve altitude separation, the first aircraft can use a level, low angle pop up, VLB delivery, offsetting as necessary for the planned delivery. The second aircraft splits at a predetermined point and pops to a high LALD or dive bomb delivery and pulls out **above** the frag envelope (Figure 5.51). To achieve distance deconfliction, the second aircraft can use LAT or a loft delivery pulling out with separation from the frag (Figure 5.52). For timing separation a split at sufficient distance to achieve the desired spacing is effective but reduces mutual support after the split. A split closer to the target requires arcing to remain within visual range and achieve timing separation. This allows the second aircraft to drop from a low altitude delivery. The distance of the arc from the target depends on the turning room necessary to achieve delivery parameters. As an example, the second aircraft arcs at 3 NM until the first aircraft's bombs explode, counts 5 seconds, turns to place the target at 10 or 2 o'clock, then executes a LALD, or VLB delivery to give approximately 30 seconds spacing (Figure 5.53). Timing deconfliction forces an excessive amount of time in the target area. This technique should only be used for a single point target.





**Figure 5.51 2-Ship Split Pop Attack, Altitude Deconfliction**

**WARNING:** Altitude deconfliction may put the wingman into the heart of some threats. Use altitudes that recover above the threat versus frag to the maximum extent possible.

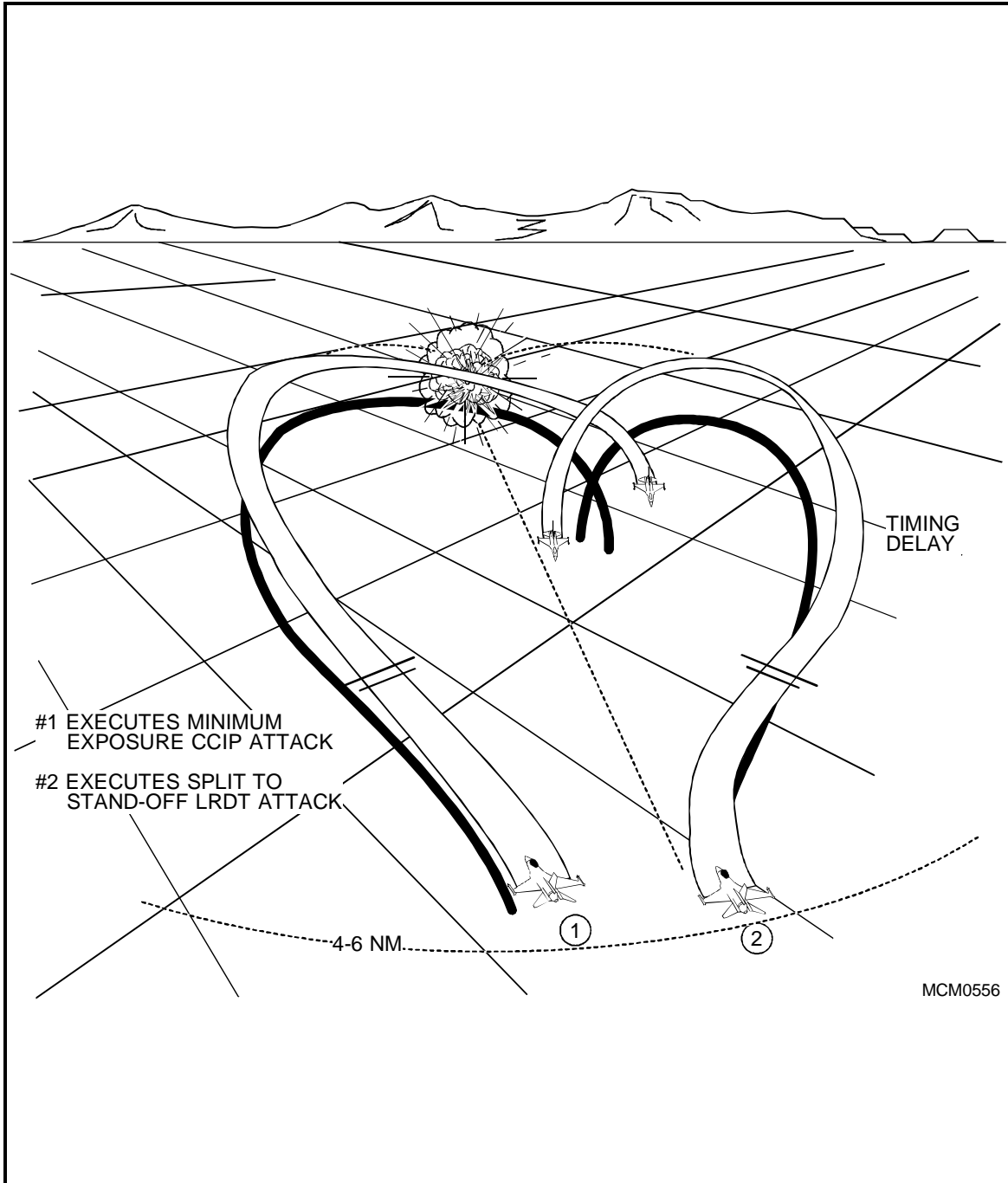
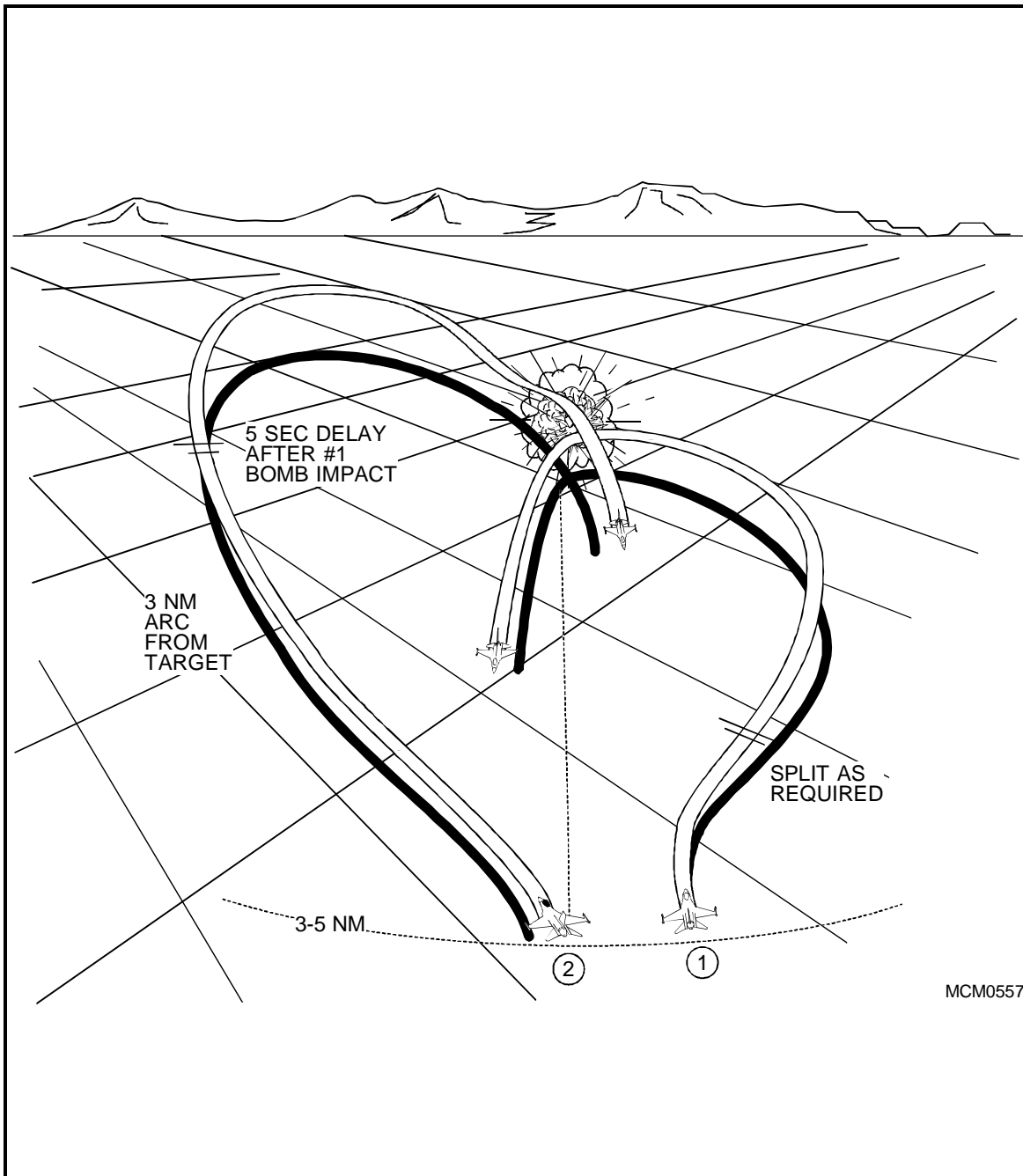


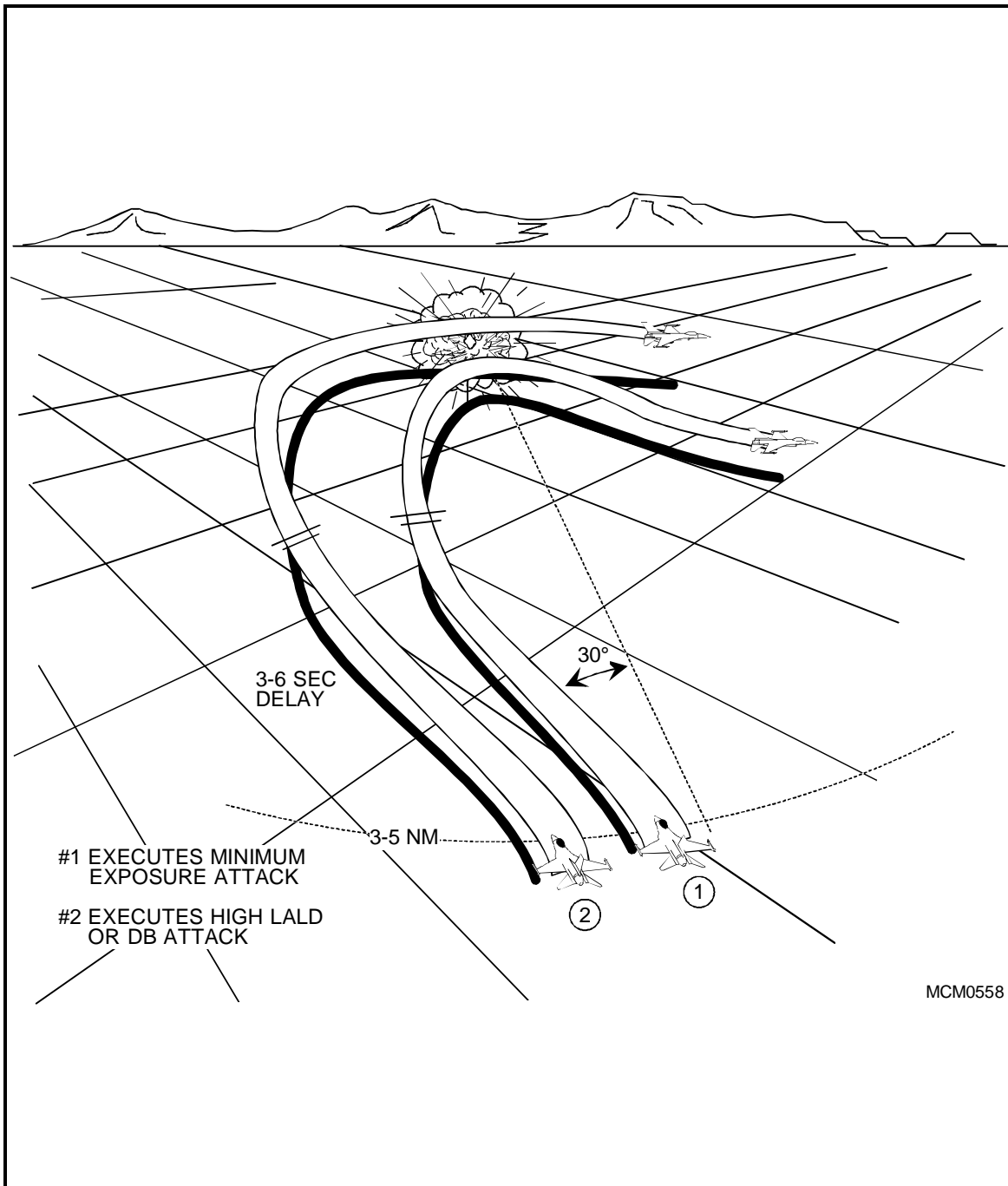
Figure 5.52 2-Ship Split Pop Attack, Distance Deconfliction



**Figure 5.53 2-Ship Split Pop Attack, Time Deconfliction**

#### 5.19.2. Echelon Pop Attack

An echelon pop has both aircraft offset to one side of the target. This attack allows the element to maintain visual contact during the ingress, and allows the wingman to fly a visual formation during the attack. Deconfliction can be achieved through altitude, timing, and distance. Both aircraft turn away from the target at a predetermined point for offset pops. The lead aircraft can use a minimum exposure delivery such as VLB. The second aircraft can achieve altitude separation by popping to a high LALD or dive bomb delivery and pulling out **above** the frag (Figure 5.54). Timing separation by arcing (Figure 5.55) or distance deconfliction by using LAT (Figure 5.56) may also be used.



**Figure 5.54 2-Ship Echelon Attack, Altitude Deconfliction**

**WARNING:** Altitude deconfliction may put the wingman into the heart of some threats. Use altitudes that recover above the threat versus frag to the maximum extent possible.

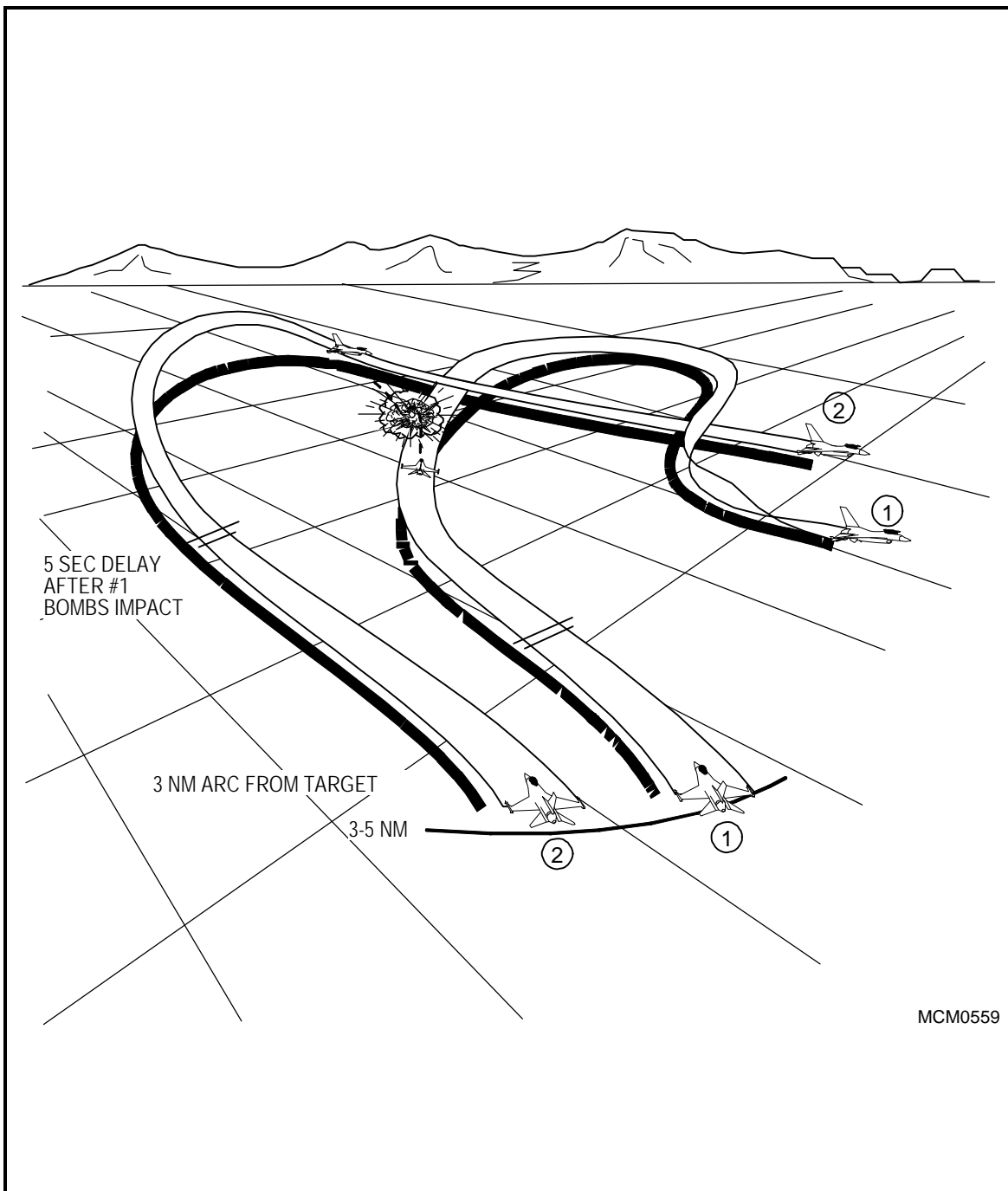
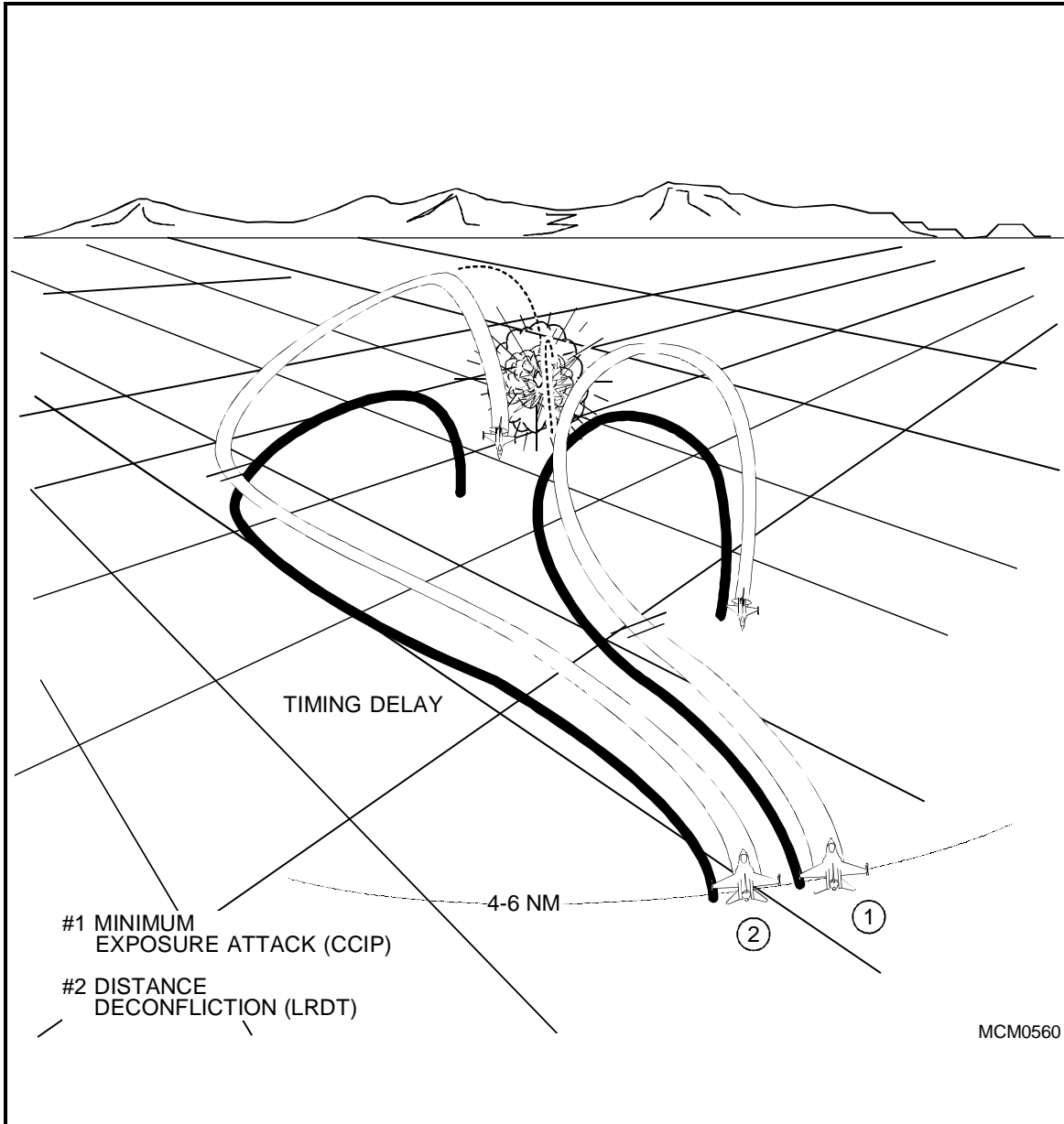


Figure 5.55 2-Ship Echelon Attack, Time Deconfliction



**Figure 5.56 2-Ship Echelon Attack, Distance Deconfliction**

### 5.19.3. Trail Attacks

A trail attack provides timing deconfliction but gives up visual support for the second aircraft during ingress. Trail formation can be achieved by a spacing maneuver such as a 90/90 (Figure 5.57) or by airspeed. Both aircraft use deliveries such as VLB or loft that minimize exposure to the terminal threats. The first aircraft breaks away from the target after release with the second aircraft watching for SAM launches. To provide visual support for the second aircraft, the first aircraft turns back across the ingress heading. This helps him reacquire the second aircraft while beaming the threats (Figure 5.58).

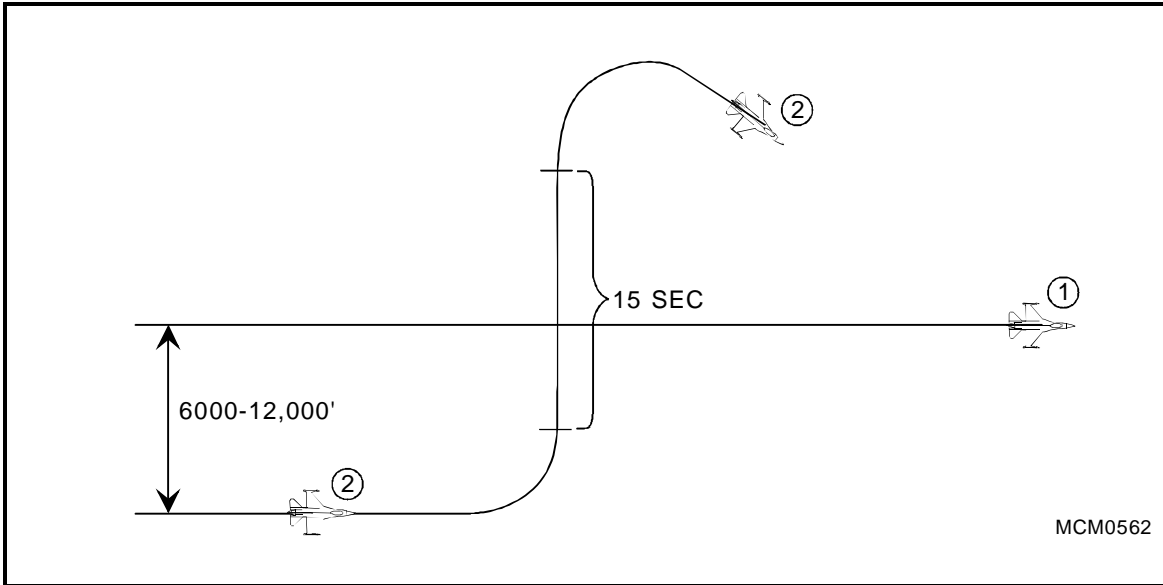


Figure 5.57 90/90 Maneuver

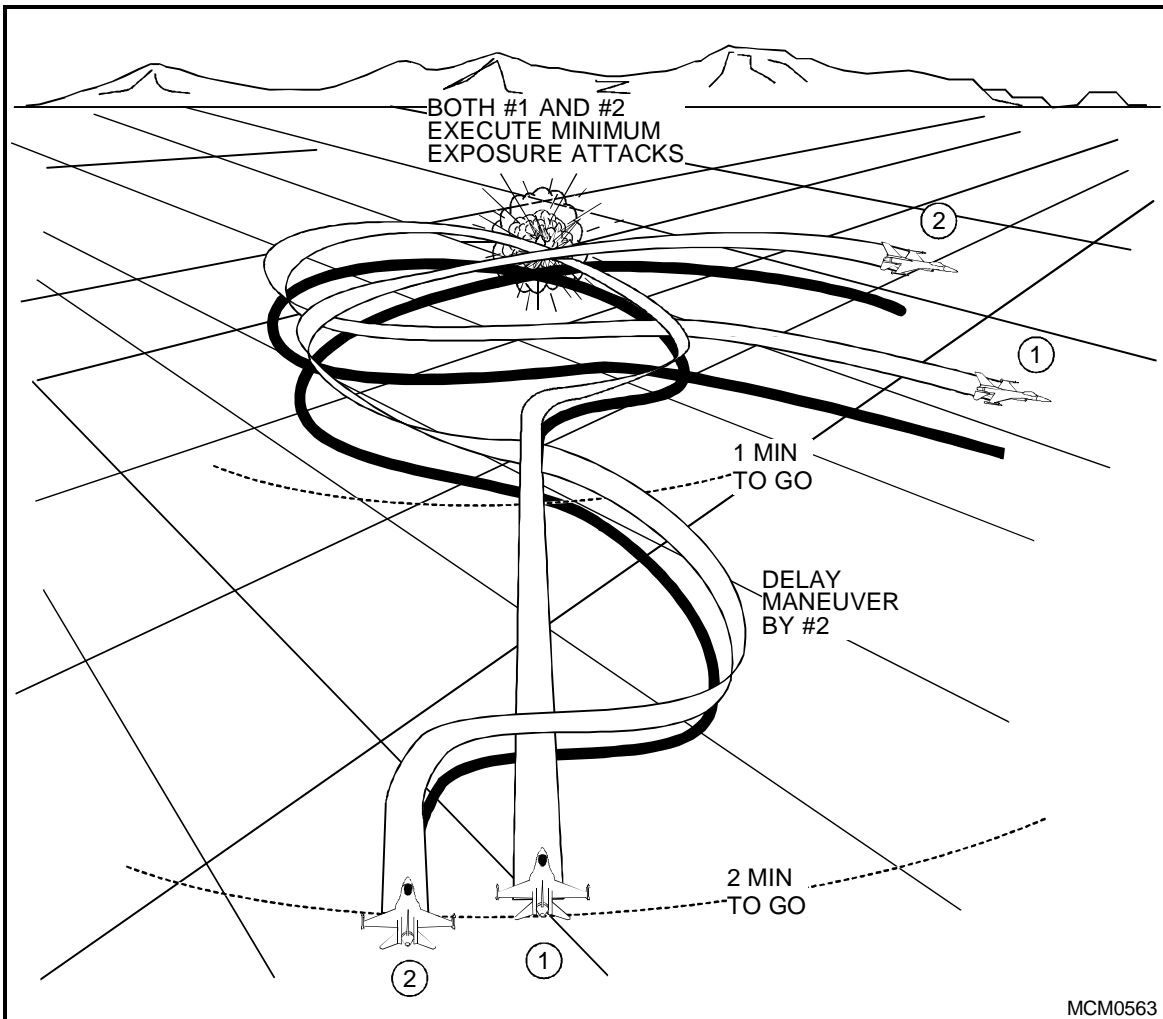


Figure 5.58 2-Ship Trail Attack

#### 5.19.4. **Shooter Cover**

The shooter cover option can be flown by a two ship and allows one aircraft to attack the target using a preplanned profile. The second aircraft stays low and provides visual support by flying an arcing pattern outside the terminal threat. After the first aircraft has delivered ordnance, the second aircraft has the option of executing its own attack, or egressing with his element mate. This option is especially viable in a very high threat arena.

The shooter's role is to find and destroy the target. If necessary, inform cover on target specifics and egress intentions. The shooter should adjust any follow-on attacks based on first-look observations.

The cover role includes providing visual look-out for air and surface threats. The cover may engage or suppress pop-up threats according to prebriefed criteria. The cover should maintain overall battle situation awareness to include new threat locations (to avoid during egress and reattacks), egress direction, and target location.

#### 5.19.5. **Loft Attacks**

Loft deliveries allow weapons to be delivered simultaneously. In case of a degraded system aboard one aircraft, a loft can be made on the wing. Another option is the individual loft delivery.

##### 5.19.5.1. **Simultaneous Loft**

Both aircraft loft the ordnance from wedge (Figure 5.59). The formation should be spread 6,000 to 9,000 feet to compensate for convergence during the loft maneuver. Prior to pull-up, the wingman steers out azimuth errors displayed on his HUD. An immediate roll/dive recovery after weapon release is recommended. Avoid a perfect 180 degree reversal as this would ease the tracking solution for ground threat systems.

Advantages:

- The laterally spread formation causes confusion for ground threats.
- Provides stand-off from target area threats.
- Each F-16 has independent loft accuracy.
- GPS-equipped aircraft can make accurate deliveries if target coordinates are accurate.
- Egress formation can be established quickly.

Disadvantages:

- Accurate deliveries may not be possible.
- Target coordinates may not be accurate.
- No good against mobile targets.
- Requires accurate system.
- Relatively good weather is necessary to maintain visual formation during pull.
- Mutual support is limited during the loft maneuver.

##### 5.19.5.2. **Loft on the Wing**

One aircraft may be required to bomb using the computed solution of the other aircraft due to system malfunction or weather constraints. In this case, the wingman flies within 500 feet of the lead aircraft, matches his pitch rate during the pull-up, and manually releases his own weapons in sequence with the leader's release.

##### 5.19.5.3. **Trail Loft**

The wingman is positioned approximately 3 miles in trail. This distance puts ordnance on target for a longer time period and reduces the potential for conflict between the leader's egress maneuver and the wingman's loft maneuver. Lead should call the direction of break off after delivery if this has not been prebriefed.

Advantages:



- Individual aircraft are free to maneuver during ingress and egress.
- Individual system accuracy increases the total mission  $P_k$ .

Disadvantages:

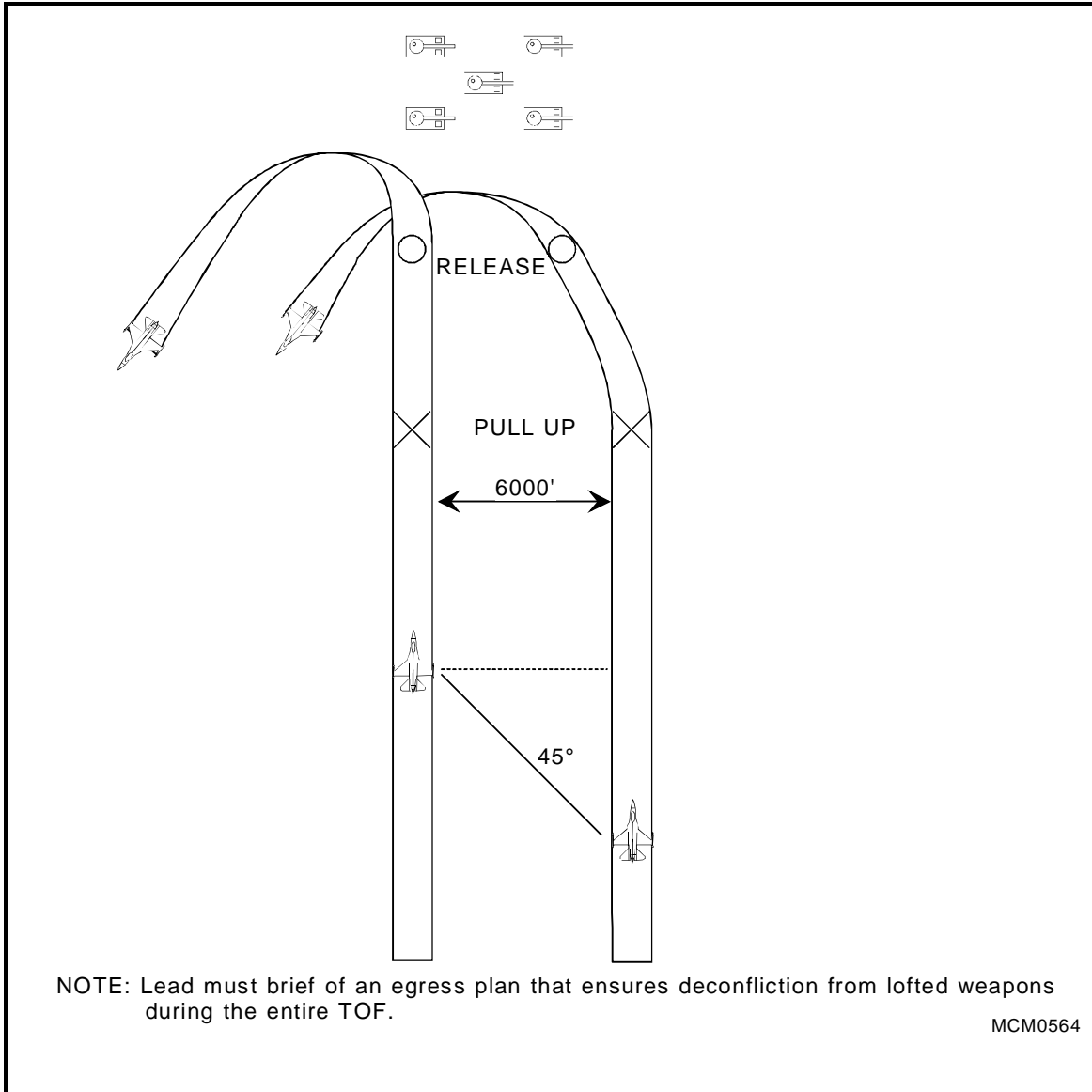
- Both aircraft must have full-up systems.
- Mutual support between aircraft is limited.
- Rejoin off target is difficult.

#### 5.19.5.4. **Aircraft and Ordnance Deconfliction**

Consideration must be given for deconfliction from lofted bombs during their time of fall.

For element lofts, it is critical that the wingman not fly further forward than wedge **and** the leader must turn away from the wingman during the egress turn. Failure to do so could result in the leader having a mid-air with the wingman's bombs.

For single-ship loft, following release, maneuver away from the bomb's trajectory. Maintain this lateral separation. There have been cases where after release, aircraft have turned back toward the target area and subsequently had a mid-air with their own lofted bombs.



**Figure 5.59 Simultaneous Loft**

### 5.20. Egress

The target area egress plan must be flexible, simple, and fully understood by all flight members. Reasons for egress/abort are:

- Target destruction.
- Poor weather.
- Unacceptable target area defenses.
- Low fuel.
- Loss of mutual support.
- Loss of required aircraft systems.
- Target acquisition problems.
- Battle damage.

Egress priorities should be based on target area threat (type, intensity, lethality), weather, follow-on attacks, status of follow-on attackers (engaged-offensive/defensive/neutral). General priorities are:

- Leave target area.
- Get away from threat envelope.
- Regain mutual support.

If a pilot becomes separated from the flight, he should follow the egress plan and provide his own threat lookout while proceeding to the prebriefed tactical rendezvous point. This point should be relatively free of defenses, allow for battle-damage checks, and provide possible initiation of a reattack. Most importantly, join with someone as soon as possible.

#### 5.20.1. Two-Ship Egress

Following ordnance delivery, both aircraft should turn toward their prebriefed egress heading. Line abreast formation provides the most effective defensive lookout. However, it may be impractical to maneuver in the immediate target area to gain a line abreast position due to target area defenses. Therefore, adhere to the egress game plan with an accepted loss of visual cross coverage. A weave back to line abreast is advised when tactically acceptable.

#### 5.20.2. Three-Ship Egress

If a three-ship is employed in the target area, the first aircraft off target should turn the shortest direction to the egress heading and provide his own lookout. The two-ship element provides its own threat detection and maneuvers to cover the first aircraft's 6 o'clock when possible.

#### 5.20.3. Four-Ship Egress

When a four-ship is employed in the target area, the elements will normally be separated by time or geographical reference within the target area for weapons deconfliction. They should maintain element integrity throughout the attack and egress as an element with visual mutual support. When clear of the target area, both elements should rejoin in an area relatively free of enemy defenses. Avoid excessive turning in the target area while attempting to rejoin a four-ship flight.

#### 5.20.4. Egress Factors

- The egress must be flexible, consider terrain, battle damage, communication, and flight responsibilities.
- In mountainous terrain, an in-trail option may be appropriate to mask defenses. Flat terrain allows for good visual cross coverage while using a line abreast formation to provide threat warning.
- Perform a battle damage check on each flight member.

Perform "wounded bird" procedures when egress cannot be flown at the prebriefed airspeed. If the aircraft is flyable, initiate egress immediately. Prior to the FEBA, RTB. Past the FEBA, if unable to cross back over the FEBA, ejection in the safe area(s) should be considered. If unable to cross, initiate "wounded bird" procedures.

Pilots should be prepared to fly the entire egress plan without radios due to the possibility of comm jamming and to keep the frequency clear for other aircraft. Visual is assumed unless wingmen make a blind call. Adhere to prebriefed flight paths and visual signals to reduce confusion during egress.

#### 5.20.5. Wounded Bird

The first priority for the wounded bird's pilot is to communicate the aircraft's status. If the level of damage is severe and the enemy threat is high enough to greatly endanger escort aircraft, the decision may have to be made to leave the battle damaged aircraft on its own to preclude further and unnecessary losses.

If the affected aircraft can maintain a minimum of 400 knots (or .8M at high altitude), then it can be escorted in a standard formation, even though the escort aircraft will have to throttle back. The escort aircraft and the damaged aircraft should clean off any nonessential drag. If the damaged aircraft cannot maintain minimum speed, then the supporting aircraft will have to stand off from the damaged aircraft in

a position from which the six o'clock can be protected. Weaves of 30° to 45° for the egress heading will allow the supporting aircraft to maintain a minimum of 400 knots while maintaining a protective position on the slow aircraft. Using 400 knots and a 45° weave means that the escorted aircraft is flying at only 280 knots. Weaves up to 60° will allow escort of a 200 knot aircraft. Weaves can be disorienting and may highlight the escort and/or the wounded bird. Another pattern option is for the escort to fly a racetrack offset from the wounded bird, on course. This pattern allows the escort to look both at the wounded bird's 6 and 12 o'clock while giving the escort time to visually reacquire the wounded bird and check his progress. If the damaged aircraft has avionics, the pilot can assume the navigation and radar search responsibilities. This allows the protector to concentrate on visual lookout for both aircraft. offensive commit criteria will be more constrained than normal. On the commit, the escort will take the lead in the acceleration maneuver and merge with bandit(s) first. The damaged aircraft should use avionics an/or descriptive commentary to get a tally and possibly some ordnance in the air after it has a positive ID from the escort (engaged) fighter.

If at any time during the egress, an active engagement ensues and a bandit approaches ordnance parameters on the damaged aircraft, the pilot must make the decision either to try a last-ditch maneuver, or to eject. If the capability exists to spoil an attempted gunshot, the pilot should direct that move above the horizon in order to preserve altitude for a safe ejection.

In a three-ship formation with a slow damaged aircraft, firepower is improved, but the escorting pattern is more complicated. Weaving behind a slow aircraft as a two-ship may do more to attract a bandit's attention. A close-tied racetrack pattern around the damaged aircraft using the radars to sanitize the 6 and 12 o'clock avenues of approach may be effective.

In a four-ship, consideration should be given to the threat arena as well ordnance and fuel available. Although you should never jeopardize all four to save one, the healthy element could be used to sweep for the damaged aircraft while his element mate escorts.

As the flight approaches the FEBA or any heavily defended surface-to-air arena, the healthy aircraft must accelerate to penetrate the defenses. If it is any consolation, the pilot of the disabled aircraft can observe the active threats as they attempt to engage the other flight member(s). This will allow course changes to make his aircraft less vulnerable to the observed threats.

Once across the FEBA, the flight member should orbit to pick up the damaged aircraft. The enemy's air order of battle (AOB) is still a threat, so "wounded bird" procedures must continue. Close to the landing base, appropriate emergency procedures should be accomplished.

## **5.21. Recovery**

Recovery options should be based on factors such as fuel, safe passage procedures, and threat detection.

### **5.21.1. Fuel**

Fuel is a primary concern on recovery. The engagement of an unexpected threat during egress may result in a fuel state that makes recovery to the primary base impossible. Pilots must have preplanned bingos during the entire recovery profile; know when to climb, when to divert, and when to jettison external tanks or suspension equipment in order to increase range.

### **5.21.2. Safe Passage**

These procedures differ by theater. A knowledge of recovery options is mandatory. Inoperative IFF/SIF equipment, radio out, etc., may force rendezvous with other friendly aircraft for recovery.

### **5.21.3. Ground Threat at Recovery Base**

Man-portable SAMs and small arms pose a potential threat during departures and recoveries.

Fly departures IAW local procedures and directives. As applicable, minimize use of afterburner and arm flares. Fly an unpredictable flight path when safely airborne.

Fly recoveries IAW local procedures and directives. If applicable, arrive on initial with 400 knots in line abreast formation. If straight-in approaches are directed, offset the aircraft in front as much as possible.

After landing, the compromise between force protection (sheltering of aircraft) and combat turnaround needs to be considered. Also, decontamination procedures may be in effect upon landing.

---

## **Chapter Six**

### **AIR REFUELING**

#### **6.1. Introduction**

Once you have mastered basic formation, air refueling the F-16 is relatively easy; it is very similar to close trail formation. The aircraft is stable on the boom, there is plenty of excess power available, and the visibility is exceptional. An in-depth knowledge of procedures is essential for safe and efficient air refueling. Most of these procedures are presented in this manual. Refer to T.O. 1-1C-1 (Basic Flight Crew Air Refueling Manual) and T.O. 1-1C-1-30 (F-16 Flight Crew Air Refueling Procedures with KC-135 and KC-10) for a detailed explanation of procedures.

#### **6.2. Mission Preparation**

Prior to the briefing, review air-to-air refueling procedures in T.O. 1-1C-1-30. Be aware that air refueling terms are defined in T.O. 1-1C-1. Obtain the air refueling information including tanker call sign, refueling track, refueling altitude block, fuel offload, refueling frequencies, A/A TACAN channel, and air refueling control time (ARCT). Determine the forecast weather for rendezvous and refueling. Note the position, coordinates, and TACAN fixes associated with the air refueling initial point (ARIP) and the air refueling control point (ARCP). This data can be found in FLIP AP/1B or the pilot aid for local tracks.

#### **6.3. Ground Operations**

During normal after-start checks, check the air refueling system. Move the air refuel switch to the OPEN position and check the air refuel status lights for a blue RDY light on and the DISC light off. In a D-model, depress the NWS/AR DISC on the side stick and check that the amber DISC light is on. Three seconds later, the RDY light should come back on and the DISC light should go out. Move the air refuel switch to CLOSE and check that the RDY light extinguishes. The crew chief will confirm operation of the AR door and slipway lights. *CAUTION:* On the ground, depressing the AR/NWS button cycles the NWS. After closing the air refueling switch, check NWS light on prior to taxiing.

#### **6.4. En Route**

There are several different techniques for setting the radar control panel to search for the tanker. The most common technique is to select 80 NM range with the acquisition symbols initially positioned in the middle of the scope and antenna elevation set so that the tanker's altitude is bracketed (elevation knob in the detent normally works). The steerpoint selected should correspond with a bull's eye that increases situational awareness. Select either the ARCP, or the TACAN used to define the track. Select medium PRF, 1 or 2 bar scan, and target history 3. Ensure the master arm switch is in the SAFE position.

#### **6.5. Rendezvous**

There are two methods of rendezvousing with the tanker: the point parallel and the fighter turn-on (Figure 6.1). The point parallel is normally used any time the tanker has no aircraft refueling and the tanker is positioned at the ARCP. The fighter turn on is generally used when there are several flights scheduled for the same tanker and one flight is still refueling as the next flight begins its rendezvous, or when the tanker is in an anchor pattern. Brief and use GCI to the maximum extent, but always monitor the geometry to ensure an efficient rendezvous. Use the INS, radar, TACAN, and air-to-air TACAN to monitor the rendezvous. Visualize the rendezvous geometry to detect deviations as they develop (e.g., insufficient lateral separation or excessive heading crossing angle). Ensure altitude separation with the tanker is maintained until visual contact is established and complete the armament safety check prior to putting the tanker in the lethal envelope for the weapons you are carrying.

### 6.5.1. Point Parallel

Normally, radio contact will be established with the tanker prior to arriving at the ARIP. Emission option 2 will be used as the normal air refueling communication procedure IAW T.O. 1-1C-1-30. If both the tanker and receivers are on a common GCI/ATC frequency to obtain ground rendezvous assistance, the change to the air refueling frequency may be delayed until positive radar/visual contact is established. If under radar control, obtain bearing and distance to the tanker prior to changing to the air refueling frequency. As soon as reliable radio contact has been established with the tanker, DME/radial information from a common TACAN should be exchanged (if available). You must be cleared by the tanker to depart the ARIP. Maintain 1,000' below the tanker until visual contact is made with the tanker.

You will proceed from the ARIP to the ARCP using all aids necessary to maintain on track. To provide range information, one flight member will normally set the assigned A/A TACAN prior to departing the ARIP. All flight members will normally monitor the rendezvous on their own radars. If the rendezvous is proceeding properly, lead should tell the tanker to begin his turn to the refueling heading at 26° azimuth on the radar at 21 NM range. A typical rendezvous radar display is depicted in Figure 6.2. The terminal stage of the rendezvous is critical. The point-parallel rendezvous with proper airspeed will roll the tanker out 3 NM in front of the fighters. If the tanker turns too late or too slowly, an overshoot may develop. If the tanker turns early or rapidly, a "cold" rollout (the tanker more than 3 NM ahead of the receiver) results. During the tanker's turn, the tanker should be 45° left at 13 NM when halfway through his turn and 34° left at 8 NM. If range is less at a checkpoint, ease back on the power and advise the tanker to push it up while you perform a slight check turn away from the tanker. If range is greater at a checkpoint, add power and turn slightly toward the tanker. Be aware that the radar may enter the coast mode during the latter stages of the rendezvous. Be prepared to use DGFT or MSL OVRD to reacquire lock-on. These checkpoints are based on the following conditions: Tanker 260 KCAS, fighter 310 KCAS, FL 300. As a rule of thumb, changing fighter airspeed to 350 KCAS decreases roll-out distance by 2 miles, thus allowing the fighters to roll out approximately 1 NM behind the tanker. The critical factor is to ensure altitude separation until established behind the tanker with visual contact. Refueling airspeed is 310 KCAS, so the tanker will be awaiting a "push it up" call.

### 6.5.2. Fighter Turn-on

You may use normal intercept techniques for a fighter turn-on rendezvous or follow the steps below.

- The fighters turn instead of the tanker.
- The fighters turn toward the tanker when the tanker is at 35° relative bearing and 15 NM slant range.
- Fighters maintain 350 KCAS throughout the rendezvous until the closure rate indicates an airspeed adjustment.
- The fighters will use 30° of bank during the turn.

The tanker should be at 7° relative bearing and 4.5 NM when the fighters are halfway through their turn. The tanker will establish refueling airspeed when requested by the flight lead. The fighters will adjust their airspeed as needed to achieve the desired closure rate. At the completion of this turn, the fighters will normally be in 2.5 NM trail behind the tanker. Be aware that the radar may enter the coast mode. Selecting DGFT or MSL OVRD will aid in obtaining a quick lock-on if the radar breaks lock.

Use caution to assure the radar contact is your tanker and not an unknown or flight departing the tanker. If in doubt query the tanker. Also compare radar range with A/A TACAN range.

### 6.6. Rendezvous Overrun

When a rendezvous overrun occurs, the tanker or receiver pilot will immediately transmit a warning to all members of the flight and initiate rendezvous overrun procedures. In the event of an overrun, the receiver(s) will pass 1,000' below the tanker to ensure positive vertical separation. The receivers will decelerate to 290 KCAS and maintain air refueling heading. The tanker will accelerate to 355 KIAS (350 KCAS) or Mach 0.90, whichever is lower, and maintain air refueling heading. When the tanker is in positive visual contact ahead of the receiver, the receiver pilot will so indicate. The tanker will decelerate to air refueling airspeed and normal closure procedures will be employed to establish contact.

### 6.7. Observation Position

As the flight approaches the tanker, the refueling boom operator will initiate a radio check which must be acknowledged by all flight members. Wingmen move to the observation position when **cleared by their leader**. This position is established to allow the aircraft in the refueling position complete freedom of movement around the contact position. Receivers in the observation position will maintain a position slightly behind the tanker wing and a minimum of one receiver wing span clearance laterally from the tanker, unless IFR or night operations require less spacing. For a reference, align the tanker wingtip light with the fuselage window aft of the wing root. Stack vertically to maintain a position which enables you to see the tip of the opposite wing above the tanker's fuselage. The IP may fly an observation position slightly aft of the one described above to allow him to observe other pilots refueling.

### 6.8. Prefueling Checks

Follow procedures detailed in T.O. 1-1C-1-30CL-1. Basically, ensure all ordnance is safe and all aircraft systems which emit electrical signals (TACAN, IFF, RADAR, ECM) are placed in a standby mode. If carrying external tanks and a full top off is desired, the air refueling door should be opened approximately 3 - 5 minutes prior to commencing refueling. This allows the external tanks to completely depressurize so that they can be filled. However, centerline tanks frequently do not completely fill, regardless of how long they have been depressurized. When the air refueling receptacle is opened the flight control gains change, but there should be no trim change requirement. Check for a blue RDY light and await clearance to the precontact position.

### 6.9. Precontact Position

When the contact position is clear and the boom operator clears you to the precontact position, reduce power slightly to move the aircraft back and down to the precontact position. Stabilize in a position approximately 50' behind (one ship length) and slightly below the boom. A common error is to stabilize, then slowly drift too far aft or be too low. Try to relax. When stabilized, notify the boomer you are ready to assume the contact position by calling "call sign, stabilized and ready." When cleared by the boomer, acknowledge, and slowly advance power to ease forward.

### 6.10. Contact Position

Movement in the vicinity of the air refueling boom must be smooth and deliberate. From the precontact position, add only a small amount of power and wait for that power change to move you forward. As you move, listen to the boomer and bring the receiver director lights into your field of view (Figures 6.3 and 6.4). A steady light means a large correction is required and a blinking light means a small correction is required. As you **slowly** move forward, up or down corrections may be required to maintain the same vertical elevation that you had in the precontact position. As the boom approaches your canopy, it should pass 2' - 3' above your head. Maintain your lateral alignment by referencing the yellow stripe on the bottom of the tanker. As the boom passes over your head, continue to move **slowly** forward another 6'- 8'. Approaching the desired contact position, the boomer will call "stabilize." A common error at this point is reducing too much power allowing the aircraft to drift aft of the desired position. Since your rate of closure has been small, a 1 - 2% reduction in power is usually all that is required. Remember that the engine trims in the direction of the throttle movement, and the amount of trim change is proportional to the amount of power change. Normally, the boomer will tell you to stabilize when you are aligned with the yellow stripe and in the heart of the boom envelope.

Once the boomer has plugged into you, the receiver director lights function automatically (the lights are controlled manually by the boomer prior to contact), the blue RDY light on the glareshield extinguishes, and the green AR/NWS light illuminates. On new or modified tankers, intercom communication with the boomer will be available via HOT MIC. If, after contact, the director lights fail to illuminate, disconnect and return to the precontact position. If the tanker crew cannot fix the problem, you may still refuel but should ask the boomer for verbal corrections.

### 6.11. Maintaining Contact

After contact, continue to fly formation referencing the tanker (Figures 6.3 and 6.4). It is difficult to perceive small movements of your aircraft, so use the director lights. The proper up-down and fore-aft

position is indicated on the lights by the illumination of the center "captain's bars" on both columns of lights. If a light other than the "captain's bars" is illuminated on either column of lights, a correction is required. Mentally preface the D, F, U, and A lights with the word "GO," and accomplish the move directed (**EXAMPLE:** GO down or GO aft). To correct for position deviations, make small flight control and power changes. Do not delay these corrections, but make them smoothly and then wait to see the results of the correction. Avoid overcontrolling. Realize that you maintain general position by visual reference to the tanker and that you refine position via the receiver director lights or the boomer verbally. In limited visibility use the tanker as your attitude indicator while in the contact position.

If you move out of position in only one direction, lights on both columns may change. For example, if you move down, you increase the boom angle and will get a GO UP indication. In addition, you may get a GO FORWARD indication because the pure downward movement has extended the boom. Understand this relationship when making corrections, e.g., if you have both the GO UP and GO FORWARD lights, you may only have to move up a little to extinguish both of them.

The KC-135 and KC-10 director lights work slightly differently. The KC-135 lights only indicate position. You may be moving rapidly aft but when passing through the ideal position, both captain's bars will light. The KC-10, on the other hand, incorporates position and trend. In the same example, moving rapidly aft will produce a GO FORWARD command even when in ideal position. Thus, the KC-10 lights may seem a little more sensitive.

The KC-135 and KC-10 differ in another way. The position of the KC-135 engines produce slight turbulence for an F-16 in an ideal contact position. This turbulence gets worse as the tanker increase its inboard power settings. So anticipate this turbulence, particularly at high altitude or with a tanker at high gross weight. This is not a problem with KC-10 tankers.

## 6.12. Disconnect

The boomer can and will initiate a disconnect if a trend toward any limit develops. If an unintentional disconnect occurs, follow tanker directions. **Return to the precontact position**, stabilize, and await clearance back to the contact position. Do not hesitate to initiate a disconnect at any time, especially if you feel safety of flight requires such action. If your F-16 approaches the upper boom limit on a KC-135, the boom could strike your aircraft. So, the upper limit for F-16 operations is 25 degrees. If you get high, the boomer will disconnect you before you see a red go-down indication.

If everything proceeds normally, the boom will automatically disconnect when the tanks are full. Remember, centerline tanks frequently do not fill all the way before automatic disconnect. It's common for F-16's to move forward immediately after disconnecting due to the sudden absence of boom pressure. Anticipate the automatic disconnect by monitoring fuel quantity and fight the tendency to slide forward. If you are not getting a top-off, the boomer will advise you when you have your briefed offload. At this time it is up to you to initiate the disconnect. As a general technique, most pilots will advise the boomer to disconnect by saying, "disconnect now." **Remain** in the contact position until the boom is clear. Both the receiver and the boom operator will acknowledge the disconnect.

After disconnect, the green AR/NWS disconnect light is extinguished and the amber DISC light illuminates. The air refueling system will automatically recycle itself, and the blue RDY light will again illuminate in approximately 3 seconds. Return to the precontact position. If no additional hookups are required, close your AR door and proceed as briefed for flight reform or return to the observation position. Check your fuel quantity prior to departing the tanker.

## 6.13. Air Refueling Emergency Procedures

### 6.13.1. Breakaway

The breakaway is an emergency maneuver designed to ensure a separation between the receiver on the boom and tanker. The tanker or receiver will initiate the breakaway by calling "tanker C/S, BREAKAWAY, BREAKAWAY, BREAKAWAY" and flash all the director lights. Expect the tanker to increase power and initiate a slight climb when clear of the receiver.



As a receiver in the contact position, depress the AR disconnect, ensure the boom is clear, and reduce power to drop back and down until the entire tanker is in sight and cross check flight instruments. Use speed brakes if necessary. Do not descend below the refueling block unless required by the emergency.

If flying the observation position, stay on the tanker's wing unless there is obviously something wrong with the tanker, i.e., engine fire. If a breakaway is called prior to any receiver reaching the observation position, the entire flight will execute the "receiver" breakaway procedure.

#### 6.13.2. Door Will Not Close

If the door will not close, you have normal flight control gains and tank pressurization with the air refueling switch in the CLOSE position. But, the RDY-AR/NWS-DISC lights may not indicate normally; the NWS light will not illuminate when NWS is engaged.

#### 6.13.3. Systems Malfunction

When any system malfunctions or conditions exist which could jeopardize safety, air refueling will not be accomplished except during actual fuel emergencies. Any time siphoning is noticed, you should be told and the boomer will stop fuel transfer. The decision to continue is yours. A small amount of fuel spray from the nozzle/receptacle during fuel transfer does not require fuel transfer to be terminated. The requirement to continue fuel transfer will be at the discretion of the tanker or pilot experiencing difficulties.

#### 6.13.4. Manual Refueling

This mode of refueling will not be used in training except for emergencies. In tanker manual refueling, the tanker will be unable to initiate a disconnect. The receiver must initiate all disconnects. Remain particularly aware of the boom limits and initiate a disconnect before arriving in position from which a safe disconnect cannot be accomplished.

#### 6.13.5. Pressure Refueling

The tanker uses this emergency refueling procedure when all other means of fuel transfers have failed and a fuel emergency exists. The boomer will keep positive boom pressure on the receptacle so the fighter may feel unusual trim changes. Because of the boom pressure, the disconnect is critical. You and the boomer must coordinate it verbally.

#### 6.13.6. NORDO Refueling

Refer to T.O. 1-1C-1-30 or T.O. 1-1C-1CL-30 for tanker and receiver visual signals for NORDO refueling. Again, NORDO refueling will only be used in an emergency situation.

### 6.14. Post Refueling

External fuel will not transfer if the air refueling door switch is in the OPEN position. Verify the switch and door are closed before continuing with the mission. Failure to do so can be disastrous.

#### 6.14.1. After Landing

Perform a thorough post flight to assure your aircraft was not damaged during refueling. Then enter the offload data to include the tanker's call sign in the AFTO 781.

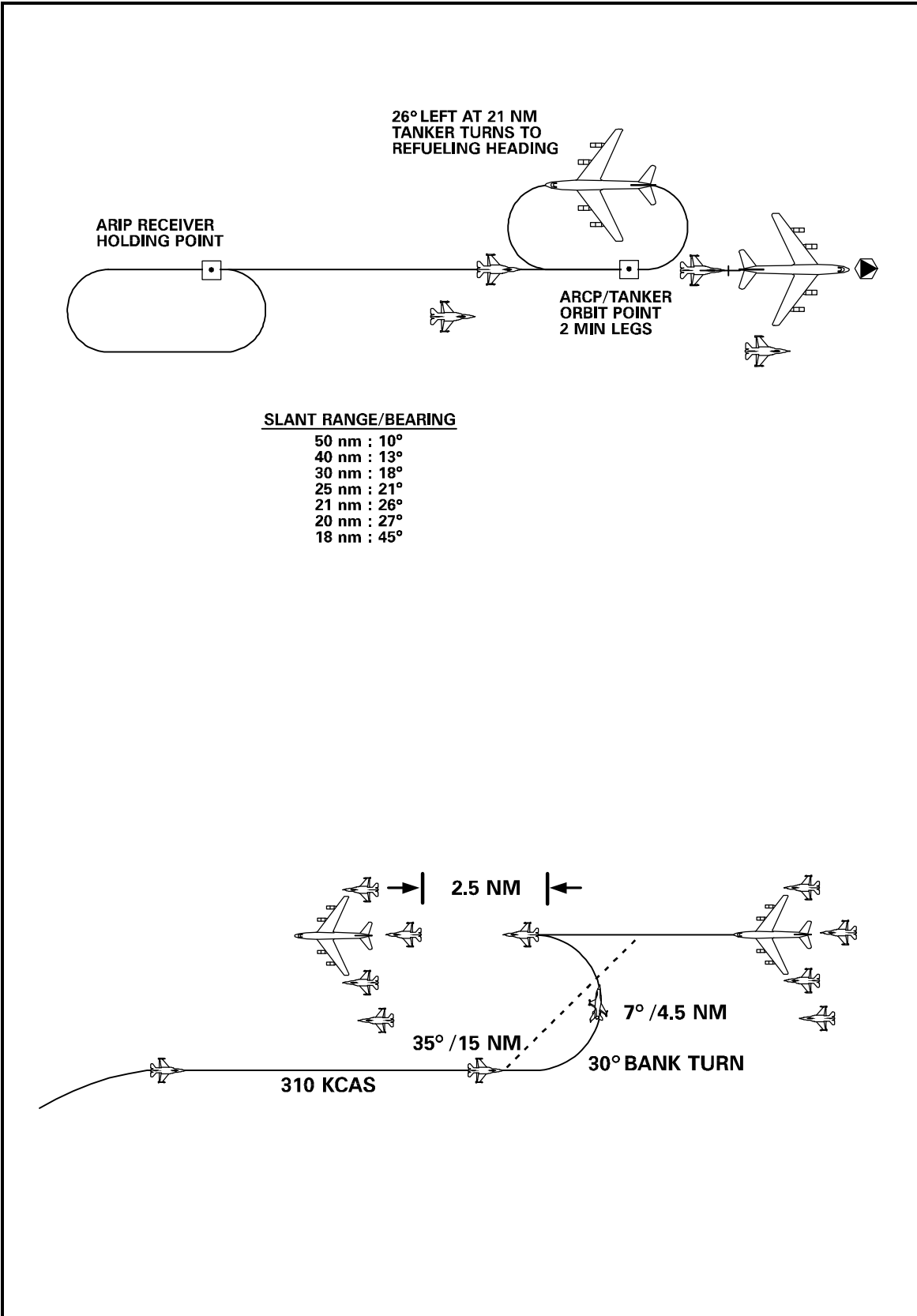


Figure 6.1 Point Parallel and Fighter Turn-On Rendezvous

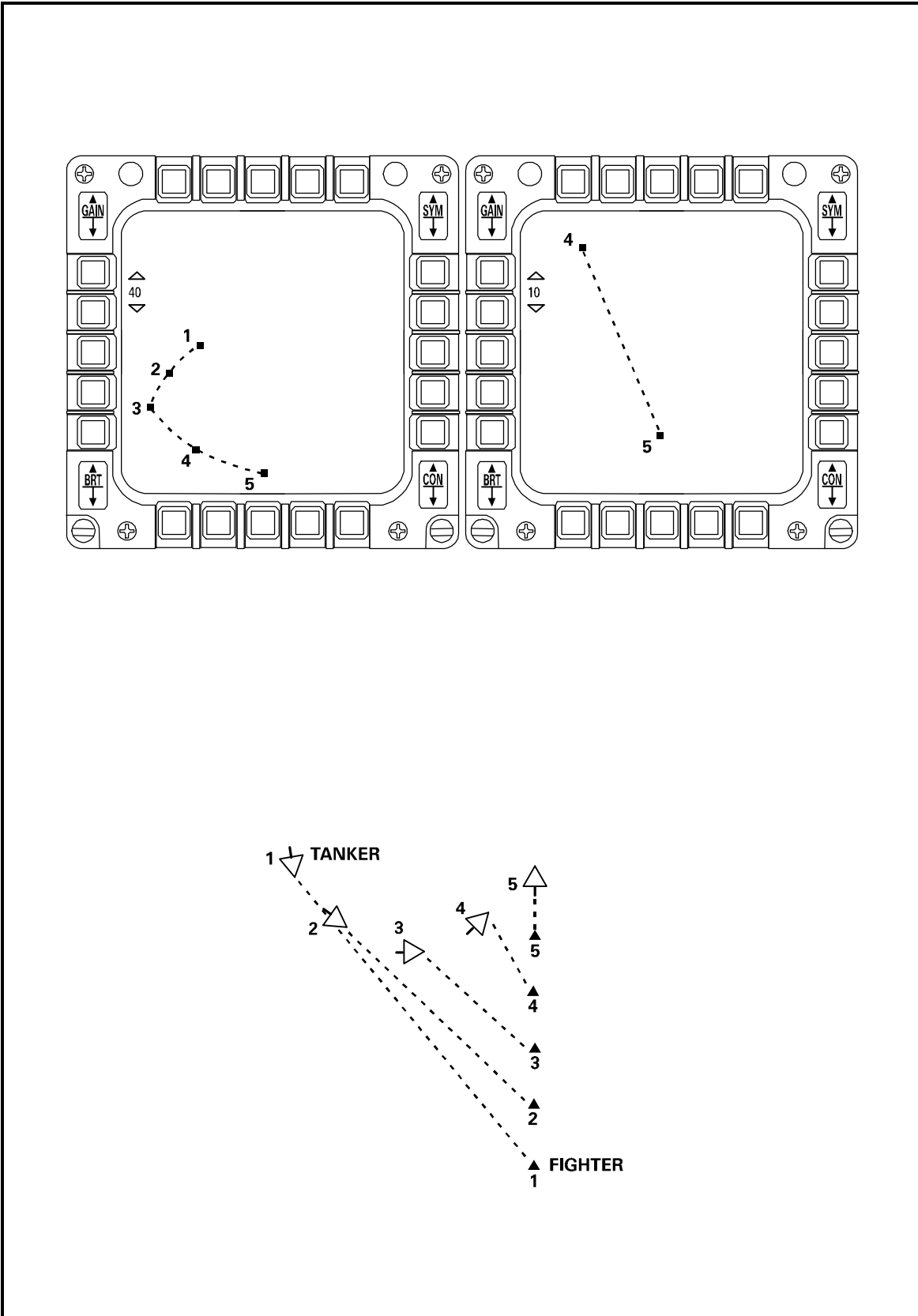
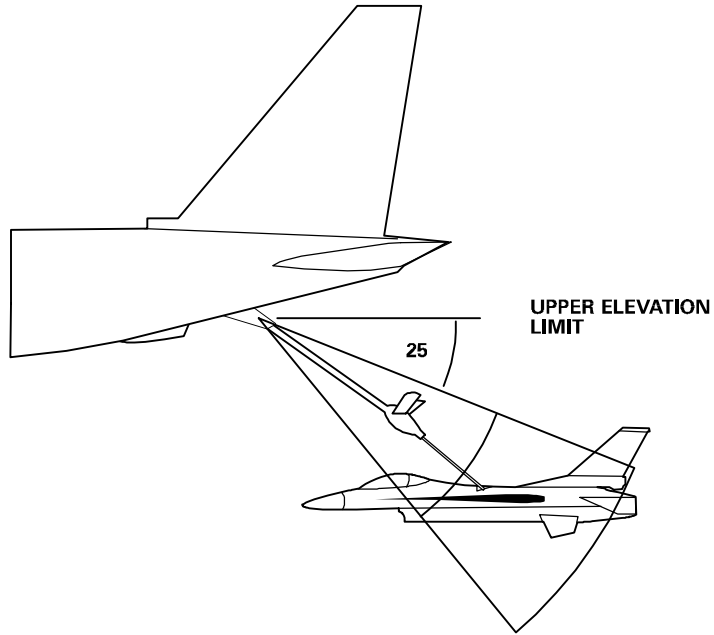
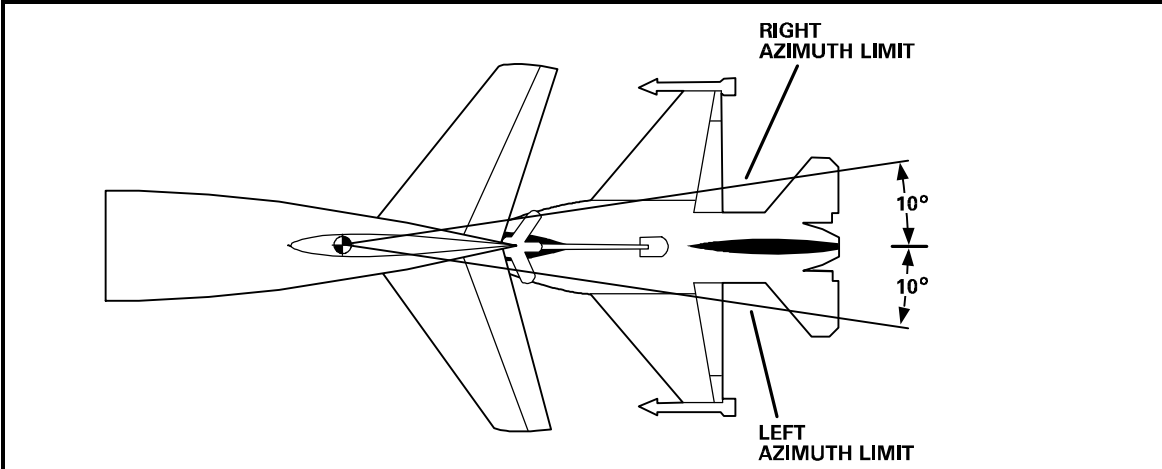


Figure 6.2 Target Progression During Rejoin



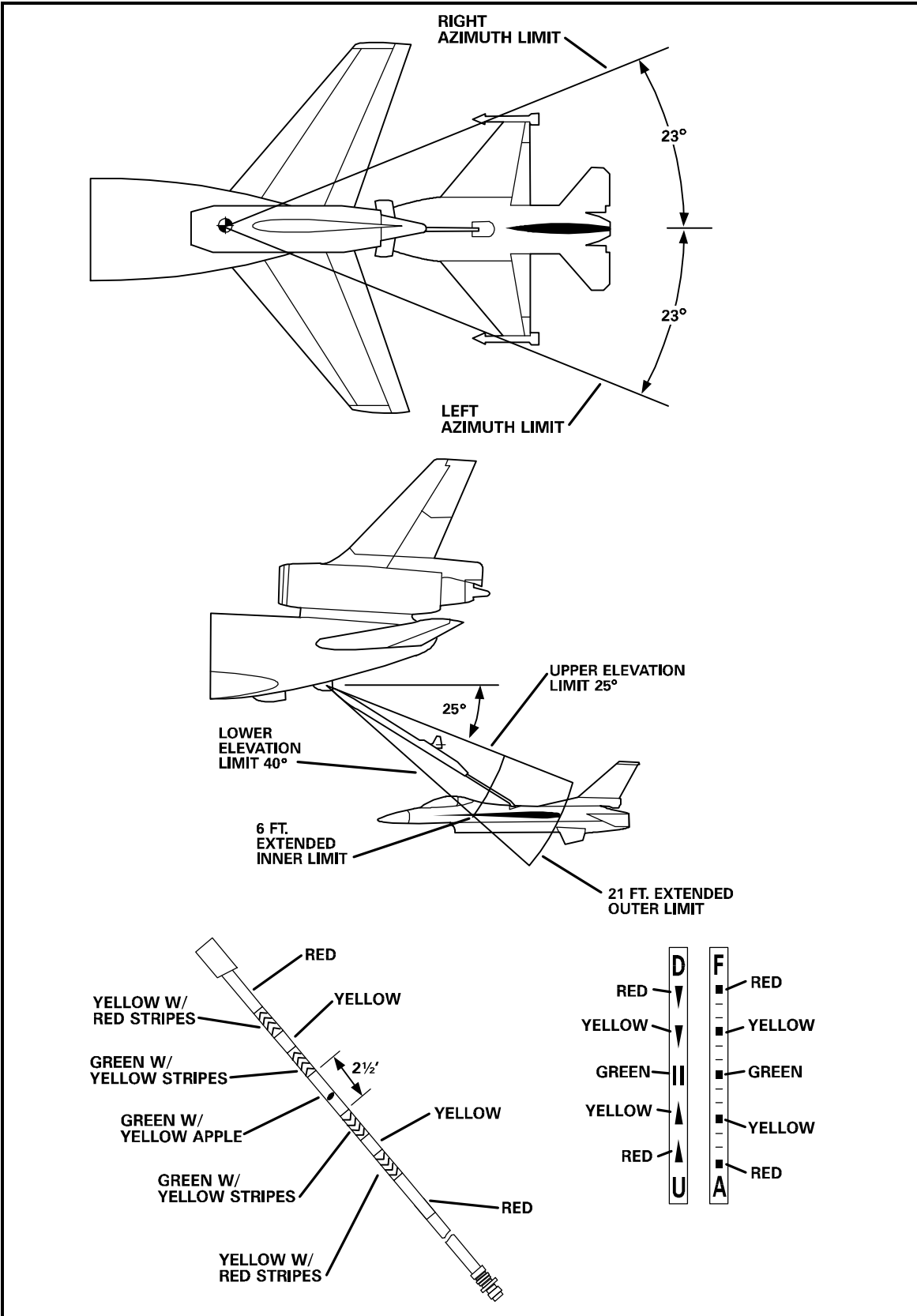


Figure 6.4 Boom and Director Lights (KC-10)

---

## Chapter Seven

### LOW ALTITUDE OPERATIONS

#### 7.1. Introduction

Low altitude flight in rough terrain may provide masking opportunities to degrade radar and visual detection, and contributes to tactical surprise. In addition to radar masking, terrain also provides optical masking. Properly executed terrain masking techniques make it extremely difficult for intercept threats to acquire the penetrating aircraft or its shadow. However, one should never fly lower than the threat, mission objectives, or comfort level dictate.

#### 7.2. Low Altitude Maps

Prepare maps IAW MCI 11-F16 Vol. 3 and MCR 55-125, *Preparation of Mission Planning Materials*.

- Highlight obstacles to the route of flight such as towers and power lines.
- Annotate the minimum safe altitude or route abort altitude.
- Determine planned fuel as well as joker/bingo at each point.

#### 7.3. Low Level Route Study

To ensure success in low level missions, thoroughly study the route.

- Know how every major point will appear, either visually or on radar.
- For visual checkpoints, consider the local weather effects (smoke, haze, dust) and the position of the sun.
- Analyze the checkpoints you'll specifically use in flight and ones you'll avoid.
- Analyze the time of year for seasonal changes of both visual checkpoints and of radar returns.
- Also analyze the route; consider which radar control settings will be the optimum for each leg.
- Review the altitude, restrictions, headings, and timing references.

#### 7.4. Low Altitude Awareness

##### 7.4.1. Altitude Low Warning System

The F-16 provides a system to warn the pilot when the aircraft goes below a set altitude (ALO or ALOW). The altitude is in feet MSL or AGL, depending on aircraft model. Enter an altitude that will allow you to see the ALO/ALOW warning function. Visual warnings are provided on the HUD, REO, FCNP or MFD, depending on aircraft model. Refer to the appropriate Dash 34.

##### 7.4.2. F-16C Combined Altitude Radar Altimeter (CARA)

The F-16C CARA system can be used for altitude management during low level operations. CARA is an aid to supplement your visual capabilities and common sense. Refer to the Dash 34 for more specific operating capabilities and limitations. Ensure the system is on and set to the appropriate altitude IAW MCI 11-F16 Vol. 3.

##### 7.4.3. Low Altitude Hazards

Be keenly and constantly aware of low-level hazards:

- Visibility restrictions, visual illusions, and low sun angles can affect low altitude SA. Terrain contours directly in front of you may be lost against the horizon. When in doubt, put the flight path marker on "blue sky."
- Subtle rises in terrain. Maintaining level flight and a constant altitude may result in significantly reduced ground clearance. Constantly check NEAR ROCKS then FAR ROCKS.
- Task saturation/fixation. The key to successful operation in the low altitude environment is a solid cross-check, appropriate task prioritization, and SA. Your cross-check should remain the same, only the time spent performing its various counterparts changes with altitude changes. Proper mission

planning and selective use of the low altitude structure will help reduce the number of high task situations that could occur.

Unperceived descents, over banked turns. Small descent angles or unplanned increase in bank angles can result in significant descent rates and ground impact. Attention to the velocity vector and altitude awareness cannot be overemphasized. Controlled flight into the ground is, in most cases, the result of misprioritization and task saturation. Regardless of your assigned or perceived tasks, pilot distraction at low altitude is deadly. Refer to Chapter 9 for low altitude awareness exercises.

### **7.5. Low Altitude Task Prioritization**

Misplaced priorities occur when a task is accomplished at the wrong place or time. Operating at low altitude is a hazardous proposition because it significantly reduces the time available to divert attention away from basic aircraft control while handling other tasks. The danger of channelized attention and task saturation is they divert attention away from the pilot's first priority - flying the aircraft.

Cockpit tasking varies at different times throughout a low level route. It is important to establish priorities when mission tasking places more demands than time allows. The following items illustrate techniques for minimizing low altitude task saturation problems.

- Terrain clearance is the primary task and should be the first task performed. When in doubt, minimize head down time or climb.
- Accomplish avionics items as early in the flight profile as possible. Many avionics items can be set prior to takeoff, thus reducing workload at low altitude.
- Accomplish critical tasks first and wait to accomplish lesser tasks later when cockpit tasking is reduced.
- Climbing to a higher altitude allows less time to concentrate on terrain avoidance and more time to accomplish other cockpit tasks. Flying low level at 500 feet is more demanding than at 1000 feet.
- Pilots must be acutely aware of flight path vector at all times. Head down avionics tasks are not appropriate if the aircraft is in a descent or banked.

One particularly busy time during low level flight is at the low level start route point. Tasking here includes timing control, steerpoint selection, avionics updates, radar search, formation, and terrain avoidance. Problems can be insidious because of arrival into the low altitude regime with little or no warm-up time before beginning the demanding workload required for low altitude operations. Flight leaders should consider accomplishing some tasks prior to descending to their minimum altitude or by delaying the descent until past the start route point. The start route point should be planned such that these options are tactically feasible.

Approaching the IP is another demanding time during which pilots must finalize attack avionics and switchology, sanitize the target area, and establish the briefed attack formation. Each pilot must continually anticipate situations of increased task loading and remain focused on task priorities in order to accomplish the mission safely and effectively.

### **7.6. Low Altitude Intercept Considerations**

Intercepting low altitude bandits requires special attention to low altitude considerations and the BFM concept of "turning room required" versus "turning room available."

#### **7.6.1. Turning Room**

At higher altitudes, overshooting the bandit's flight path can result in a low energy/lag position in relation to the bandit. In contrast, overshooting a bandit during a high-to-low conversion can result in a collision with the ground. Prior to starting any conversion turn, always confirm altitude above the ground and turning room available. Plan your conversion turn using both horizontal and vertical turning room for optimal performance. Limit your bank angle to 135° during the turn. Continue to assess altitude and ground clearance throughout the turn. If there are any doubts, put your lift vector above the horizon to reduce the descent rate. If necessary, don't delay performing a high/low speed dive recovery.

### 7.6.2. **Airspeed**

Airspeed at low altitude is important due to increased aircraft performance and G sustainability. Higher energy states can be gained and sustained compared to higher altitudes. Aircraft turn rate and radius can be maintained in the optimal range for greater periods. For high-to-low conversions, a starting speed of 425-450 KCAS allows excellent turn performance and a high energy state throughout the turn. For low-to-high conversions, a higher starting speed may be required (approximately 500 KCAS) to maintain optimal performance. Adjust power and use speed brakes to prevent gaining/losing excess/optimal airspeed.

### 7.6.3. **Avionics**

Maximum attention must be dedicated to looking outside the aircraft during a conversion turn to ensure deconfliction with the ground and an early tally on the bandit. Therefore, weapons avionics must be set prior to beginning the conversion to the maximum extent possible. A thorough knowledge of avionics and switchology is required prior to accomplishing low altitude intercepts. Expect weapons envelopes to be reduced at lower altitudes.

### 7.6.4. **Ground Avoidance**

Ground avoidance is the primary concern during high-to-low conversions. However, intercepts for high-to-low conversions require emphasis on terrain avoidance/awareness during the intercept phase prior to the conversion turn. Closely monitor aircraft attitude and altitude, as a shallow descent can lead to ground impact. Use of autopilot can help in the area, but requires close monitoring to ensure continued terrain avoidance. ALOW, CARA, and other aircraft systems may also be used to help avoid collision with the ground.

## 7.7. **Low Level Navigation**

### 7.7.1. **Dead Reckoning (DR)**

Dead reckoning is the basic method for navigation. DR is based on flying a precise heading, at a precise airspeed, for a precise amount of time. With all avionics available, DR is normally not required as the sole method for navigation, but you wouldn't be the first pilot to have been led astray if the INS points to the wrong location. Turning at the identified turn point is obviously the maneuver of choice. However, if the turn point is not found, the turn to the next destination must be made on time.

### 7.7.2. **Visually Assisted Navigation (Map Reading)**

Map reading (also called "pilotage") is the determination of aircraft position by matching checkpoints on a map with their corresponding terrain or man-made features on the ground. Checkpoints should be features or groups of features which stand out from the background and are easily identifiable. In open areas, any town or road intersection can be used; however, these same features in densely populated areas are difficult to distinguish. Select a feature on the map and then find it on the ground, rather than work from the ground to the map.

When in flight, align the course line on the map with the nose of the aircraft so that features on the map appear in the same relative position as landmarks on the ground. Then determine the approximate map position of the aircraft by cross-checking elapsed time on the clock vs the time marked on the map, as well as INS mileage from programmed turn points. Cross-check your location with a significant checkpoint near this approximate position. It is important to work from the map to the ground since the map may not portray all features on the ground.

If you are uncertain of your position, check every detail before confirming a checkpoint. The relative positions of roads, railroads, airfields and bridges make good checkpoints. Intersections and bends in roads, railroads, and rivers are equally good. Where a landmark is a large feature, such as a major city, select a small prominent checkpoint within the larger area to fix the position of the aircraft. Where a landmark is not available as a ground reference, fall back to DR/INS procedures and turn on time/INS. Following are checkpoints that can be used to confirm your position. Some checkpoints are not suitable for turn points.



### 7.7.3. Computer Assisted Navigation

The FCC/GAC, with the INS, CADC/ADC, HUD, and radar provides information to aid navigation and may be relied upon to assist navigation once these systems are proven reliable.

*Verify Heading:* To verify the precomputed heading, turn to the planned heading and then cross-check the destination bearing on the HSI. The HUD NAV steering bar/symbol is wind corrected and will be centered on the FPM when you're tracking directly for the destination.

*Verify GS:* Cross-check your adjusted indicated airspeed/mach against GS. At usual low level density altitudes, GS will be slightly higher (approximately 5% - 10%). You can also verify GS by comparing INS miles to go vs time-to-go. For example, at 480 knots GS, when the DME indicates 24 NM to go to your destination, your elapsed time should be 3 minutes less than the turn-point time. Adjust your indicated airspeed only after confirming that the computer speed is reliable.

*Verify Position:* The distance readout on the HSI (NAV) can be used to confirm the distance to go to a particular turn point or target and help to confirm your present position.

*Verify Time:* Time-to-go information on the HUD should also correspond to the map and NAV DME vs GS. In addition, FCC/GAC time-over-steerpoint (TOS)/time-over-target (TOT) can be compared with computed real times for very accurate timing adjustment.

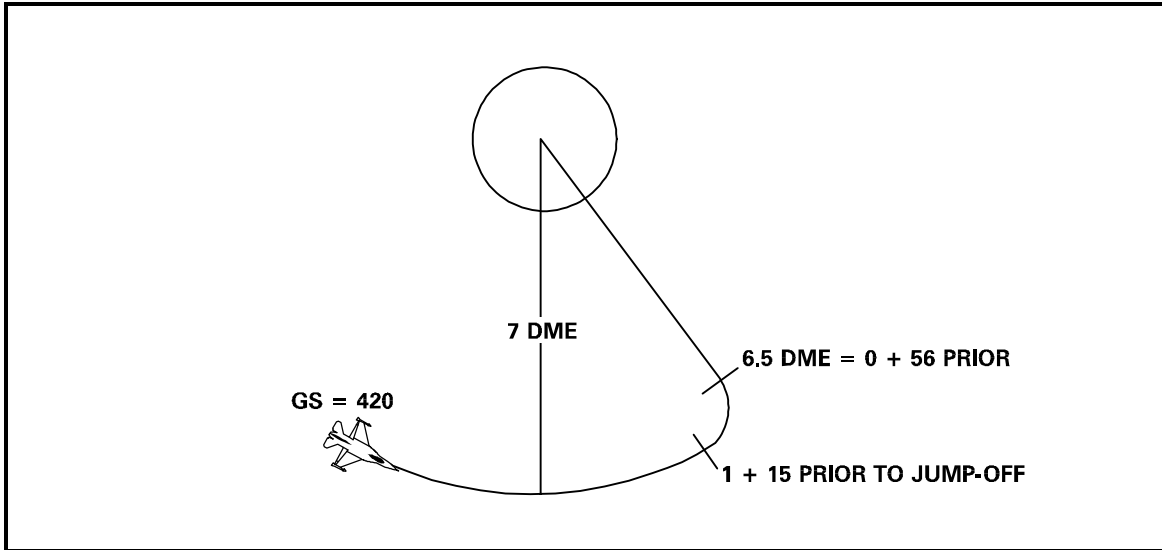
### 7.7.4. Low Level Route Timing

If during the mission planning phase, you were only able to compute elapsed times from either takeoff or the start-route point to the target there are several ways to calculate your TOT/TOS using real times. One way (F-16A) is to determine the elapsed time to fly from the start of the route to the target and then subtract this from the real TOT. This real time is the "start-route" time, or "hack" time. If you're over the start-route point at this time, you can fly the route as planned and drawn on your map. With the hack time as a base, add the elapsed times to intermediate points to determine what real times you should be at those points. In the F-16C, subtract out the elapsed time over the target steerpoint using Delta TOS. Now add the desired time over target using Delta TOS. Confirm the target TOS and note any other significant steerpoint TOS's such as the jump point.

The ultimate objective is to hit your target on time. Starting the route on time, airspeed and heading will help you work towards achieving this objective. As a technique, allow some time between takeoff and start-route time for some delay and still be over the start-route point at hack time. If you takeoff late, or get delayed en route, you may have to fly faster than programmed, or cut off part of the route to save time. Depending on the situation, it may be better to adjust your TOT/TOS rather than run short of fuel. You should be aware of the maximum route adjustment for your mission, both for time and fuel considerations.

If you takeoff as planned or early, you should delay arriving at the start-route point. You can use the FCC/GAC to help you pick a speed. The TOT/TOS clock will provide tremendous help. If speed adjustments alone will still get you there early, you have several alternatives:

- Start the route early and fly the first leg slower than planned until you're on time. But, don't forget to hack and don't slow down below a tactically sound airspeed.
- Arc around the start point until you compute it's time to turn towards it (Figure 7.1). Figure the time to fly direct from you present DME to the point, add 15 seconds for a 60° bank turn of greater than 90° and turn to the start point that much before planned jump-off time.
- Hold in a race track pattern, either en route or at the start-route point. ATC restrictions may require that you fly the pattern in the route structure, so know where you should and should not hold. A viable variation of the TOT/TOS clock technique is to start your turn inbound, using a steep angle of bank (approximately 60°), when the clock shows a 30 second early arrival. When you roll out inbound to the jump point, you should be quite close to on-time. Don't chase the airspeed caret in an attempt to make it exact; this leg will probably be quite short.



**Figure 7.1 Arc to Start Point**

If you cross the start point at the hack time, fly the programmed GS. There are rules of thumb for adjusting speed to get back on time. For example, increase/ decrease GS, configuration permitting, by 1/6 (for 480, change 80 kts) and hold the correction 1 minute for every 10 seconds you are off time. Normally, F-16 pilots take a more "macro" view and try to get on time by the next steerpoint, changing speeds until the FCC/GAC computed arrival time matches the planned time. If the required speed change is too great, try for on time 2 or 3 points further down track. You can also gain or lose time by short-cutting or overshooting turn points.

#### 7.7.5. TOT/TOS Clock

The FCC/GAC will project the elapsed time to a selected event and display it in the HUD. In the NAV mode, the event is TOS overflight and in CCRP it's time-to-release, and in LADD it's time to pull-up followed by time-to-release after passing the pull-up point. The FCC/GAC, once given TOS times, can be used to display a real world time estimate. Mode selecting the TOT clock will then result in an airspeed caret being displayed in the HUD indicating the speed necessary to arrive at the selected point on time, effectively solving your timing problems from the previous paragraph. The use of the delta TOS function in the F-16C provides an easy method for making changes to TOS/TOTs. The pilot inputs the correction as a positive or negative value and the FCC will apply the correction to all TOS entries.

#### 7.7.6. Flying The Visual Low Level Route

Cross your start point at the briefed altitude, on time, on airspeed. Hack your clock if necessary.

Determine whether or not you have an initial timing error or any INS drift with reference to your HUD steerpoint diamond.

Establish the low level altitude referring to the cockpit altimeter, radar altimeter and outside references. Emphasis at the start route point should be on low altitude transition. Tasks such as formation position, reading the map, hacking FCNP/TOS clock, and checking six should be done prior to low altitude transition, or after you are established at low altitude wings level flight. *NOTE:* Minimize heads-down time at the start route point. This is a critical time during the flight and attention to the velocity vector and altitude awareness cannot be overemphasized.

Adjust your airspeed/GS to remain on time. Cross-check your clock time at the turn points to confirm your overall timing.

Remain on track by frequently cross-checking time/map/ground at predetermined points. If you need to update your systems you will want to fly over or near the turn point. If you don't require an update, flying directly over a turnpoint is not necessary. Remember, turnpoints are a guide or road map to get to the IP and target on time. If you do not visually acquire the turn point, turn on time.

Avoid these common tendencies:

- Power creep. Set, leave, and cross-check the exact throttle setting that you desire. Find a **fuel flow** that holds computed GS and always return to this value after any throttle transient.
- Altitude variations from planned. Strive to maintain the prebriefed altitude for that portion of the mission. Cross-check your altitude at known steerpoints then return to "eyes out."
- Insidious heading changes. Cross-check your heading to preclude course deviations resulting from poor heading control. Check aircraft rudder trim to center the "ball."

#### 7.7.7. Flying The Radar Low Level Route

Although radar navigation is the same as visual navigation in most respects, there are certain differences that require emphasis. Remember that radar is an aid to the basic dead-reckoning navigation.

Radar routes are flown at or above the minimum safe altitude (MSA). This should be the altitude indicated on your map. Cross the start point on altitude, considering time and heading as in visual navigation. The autopilot/TFR can be useful in maintaining altitude while freeing your hands for other tasks. TFR MUST BE MONITORED. To verify DR calculations of position, when using the radar, use the TIMS checklist:

- **T = Time.** Check the time and find your approximate timed position on the map.
- **I = INS.** Check your timed position with the INS/FCC heading and distance to the next turn point.
- **M = Map.** Locate your approximate position on the map and determine the prediction of the point of interest.
- **S = Scope.** Check the radar scope to verify your prediction, thus your position. If nothing can be positively identified, return to the clock and start the procedure over.

Fly the route as a composite radar and visual mission. Visual sightings of radar returns will reinforce your faith in your radar prediction skill. Initiate the turns over the route turn points.

The F-16C allows a great deal of flexibility in assigning different radar modes to "hands-on" switches. ACM in the dogfight position, RWS in the missile override position, RWS in the NAV master mode, TWS in the A-A master mode, and CCRP in the A-G master mode is one example of a preflight setup. This option allows the pilot to search in missile override without losing GM in the A-G master mode. Auto acquisition is available using dogfight, and TWS is available for sorting or station keeping. Use the OVRD button on the radar display with caution as this will prevent the radar from transmitting in any mode. Assigned radar modes should be based on mission objectives/requirements.

### 7.8. Low Altitude Maneuvering

There are many challenges during low altitude operations requiring special emphasis due to increased risk for collision with the ground. Descents into the low altitude structure and ridge crossings are two examples. Although these are discussed fundamentally, these principles apply when performing additional tasks such as high-to-low intercepts, pop-up bombing attacks, or threat avoidance during ingress/egress.

#### 7.8.1. 50% Rule

For high-low transitions, the 50% rule is used to determine maximum safe flight path angle for a 90° turning roll-in (Figure 7.2). The dive angle is equal to 50% of the pre-roll-in altitude AGL in hundreds of feet. For example, if your current altitude AGL is 4000 feet, you can safely accomplish a 90° roll-in to a maximum 20° dive. If you are 2000 feet AGL, 10° is the maximum. This rule is easily applied to repositioning on a target from a pop-up or when rolling in on a tactical target from a wheel pattern. Obviously, because of the variability associated with roll-in techniques, this rule is not precise. However, the 50% rule does prevent the gross incorrect estimates of safe dive angles based on false human perceptions of AGL altitude.

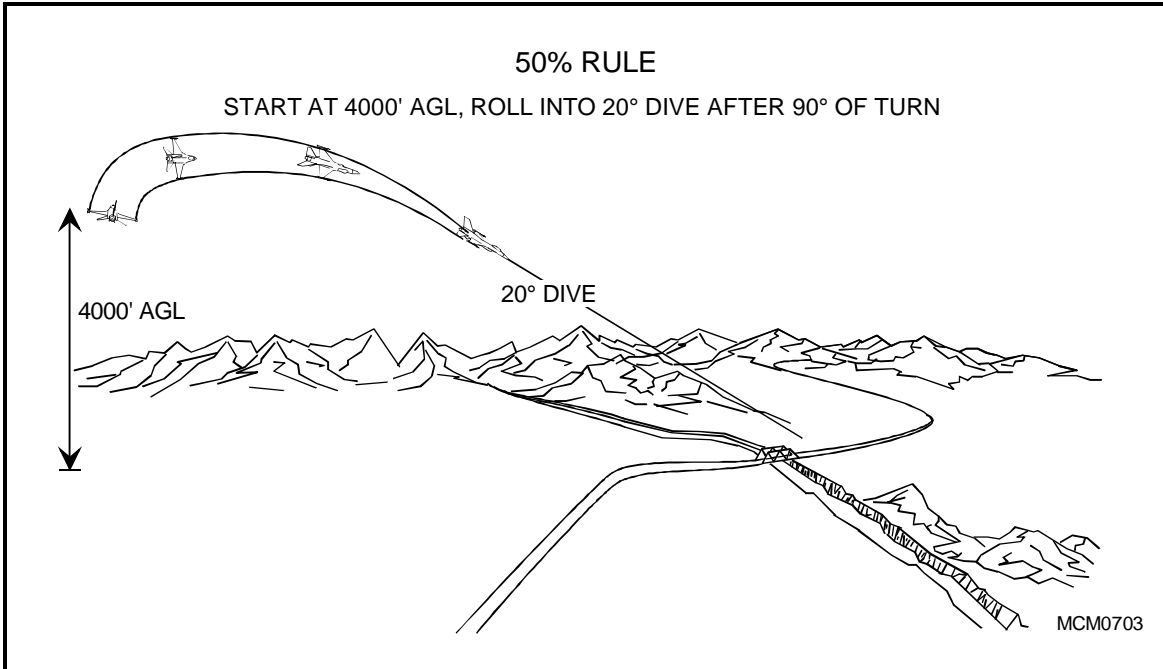


Figure 7.2 50% Rule

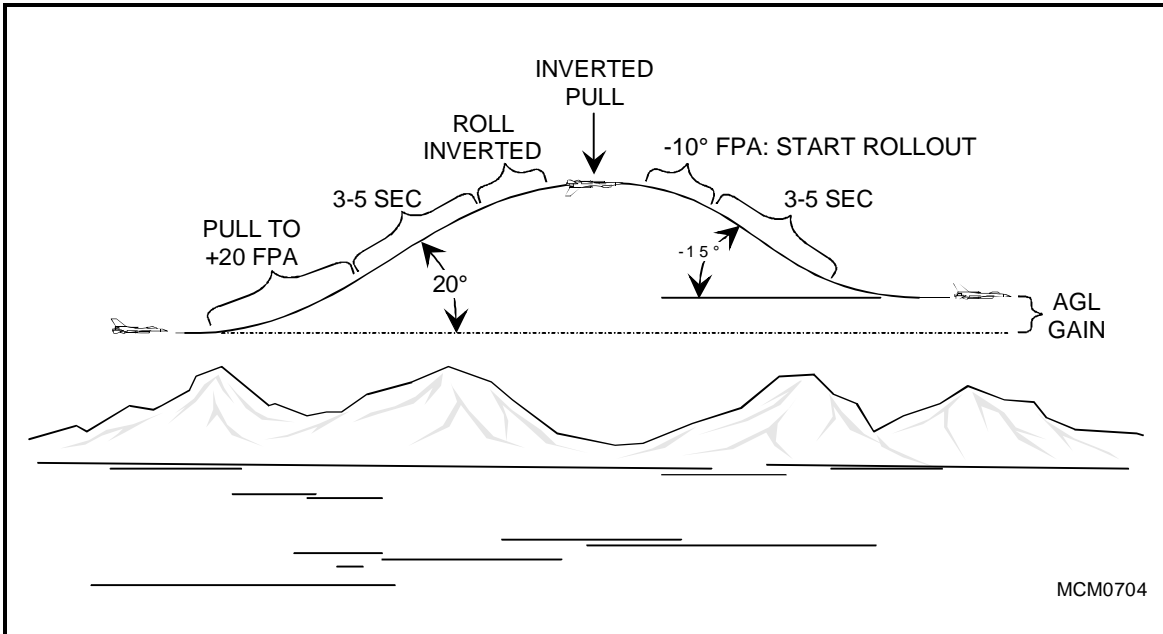


Figure 7.3 10° Rule Example

7.8.2. 10° Rule

The 10° rule applies to the low-high-low maneuvering such as pop-ups and vertical jinks over flat terrain (Figure 7.3). It is used without any reference to altitude because it relies on the control of time and geometry to ensure altitude clearance. Simply stated the 10° rule is: to return to low altitude after a climb, roll inverted and pull down to a dive angle 10° less than the climb angle. Roll out (expect dive angle to increase 5° during roll), hold the dive for the same number of seconds as in the climb, and recover. For example, in Figure 7.3, the climb angle is 20° and the climb is held for 5 seconds. The roll-out from the inverted pull at the top is started at 10° of dive angle and the nose drops an additional 5° during the roll. The descent is held for 5 seconds (equal to the time in the climb), and then the dive pull-

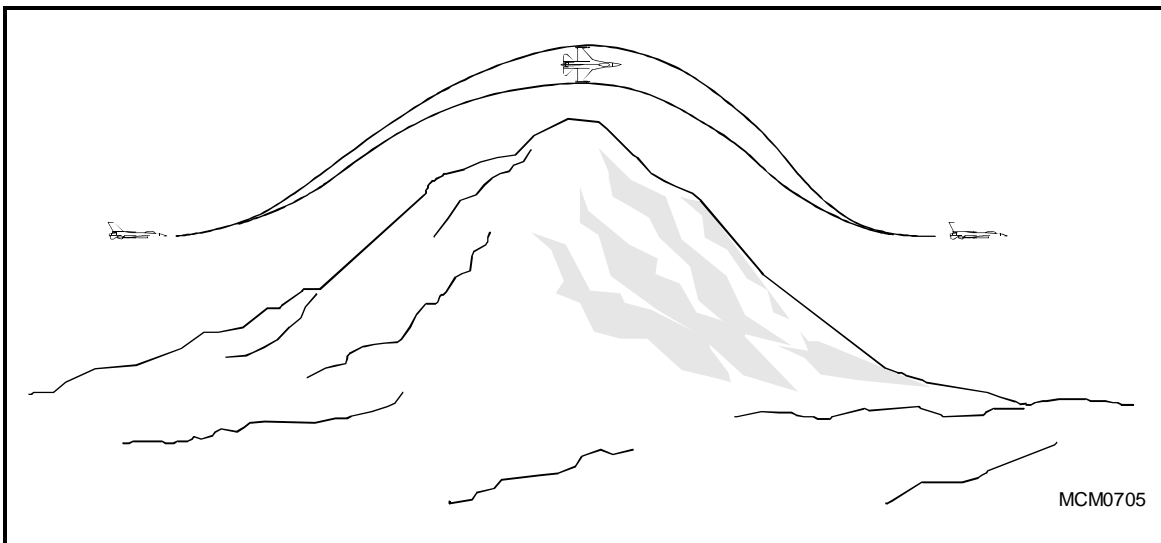
out is accomplished to level flight. The 10° rule allows unlimited tactical use of the aircraft's vertical maneuvering envelope while ensuring safe terrain clearance. The descent is 5° less than the climb, making it an altitude gaining maneuver. However, there are several factors which define this maneuver's limits. First, the rate of pull-down must be equal to or faster than the rate of pull-up. Second, airspeed during the pull-up and pull-down should be similar. Time control is imperative. Simply add extra time to the climb portion of the maneuver in order to give you more buffer.

### 7.8.3. Ridge Line Crossings

Crossing ridge lines in high threat areas is a dangerous move. The aircraft is highlighted to threats, both surface and air. Avoid ridge crossings if at all possible. Obviously, many situations force you to cross ridges. If possible, cross a ridge at its lowest point or in a saddle. Sound planning and practice of ridge crossing techniques can be a great aid. Three techniques are commonly employed.

#### 7.8.3.1. Perpendicular

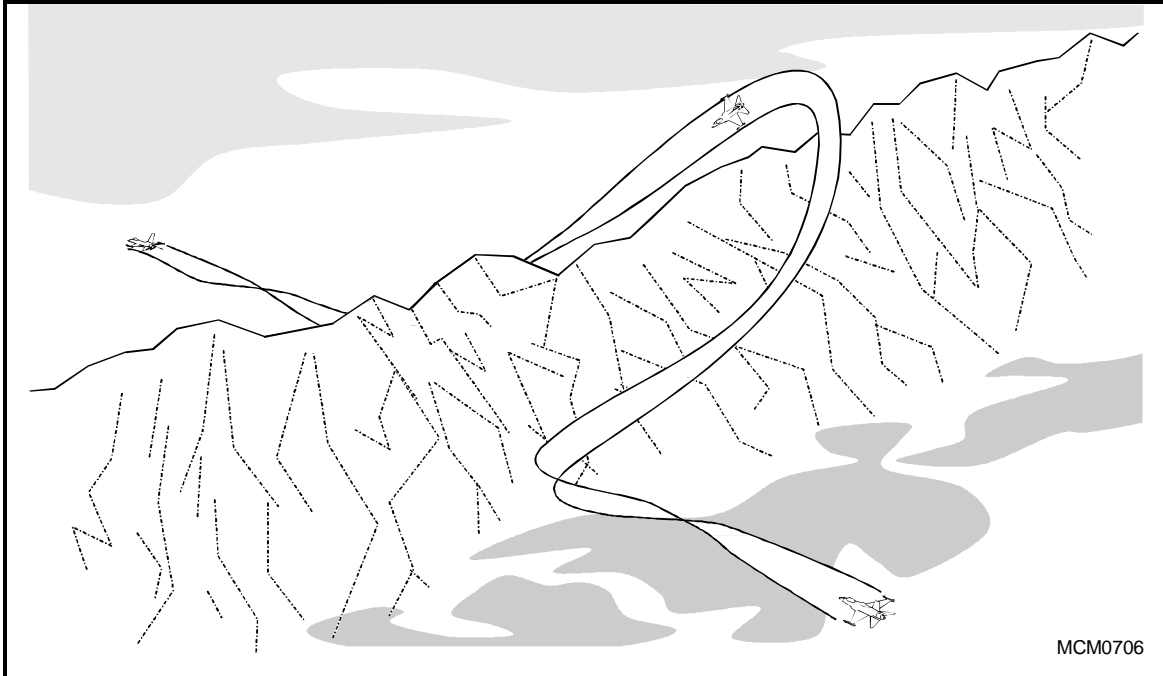
This crossing minimizes enemy radar or visual acquisition but should be done only when you know your six is clear (Figure 7.4). Accelerate as required to maintain tactical airspeed during the pull-up. Pull early enough to avoid a large overshoot crossing the ridge, so you crest the ridge at your specified minimum low level altitude. To go down the back side, bunt or roll and pull. A totally inverted pull-down is prohibited. At the crest, unload and roll to approximately 135° of bank, then slice down. At the desired nose low position, roll out and resume low level flight. Initial attempts at this technique should be limited to a 15° nose low attitude. **DO NOT** bury the nose in the new valley. This maneuver may put you belly up to unexpected high terrain on the other side of the mountain. Also, the wing flash during the maneuver is highly visible to threats. The roll and pull technique is most effective when crossing large, steep, isolated ridge lines. A bunt or pushover is more appropriate milder, rolling terrain. The pull-up for a bunt/pushover should be initiated early enough to avoid excessive ballooning over the ridge. The advantages of bunt are straight line navigation, no wing flash, and less disorientation.



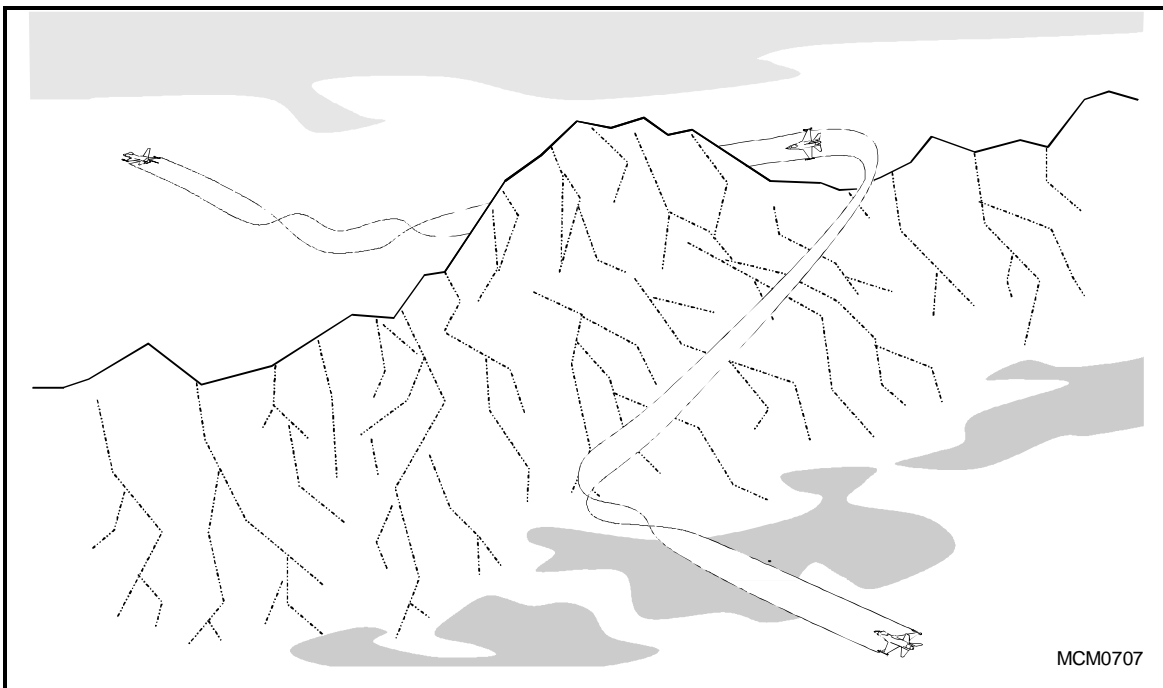
**Figure 7.4 Perpendicular Ridge Crossing**

#### 7.8.3.2. Parallel

This type of approach is appropriate if your six is, or may be, threatened (Figure 7.5). It denies the bandit a blue-sky background and provides a difficult guns environment. Instead of a straight approach to the ridge, turn to arrive at the pull-up point with approximately 45° of crossing angle to the ridge. Pull up later than for a perpendicular crossing, and continue to turn in the climb to be parallel to the ridge crest just below the top. Roll and pull into the ridge, to cross the crest at your specific minimum altitude. Continue a loaded roll to fly down the backside of the ridge, on a heading 90° to 135° from the ridge line. Roll out and continue the low level.



**Figure 7.5 Parallel Ridge Crossing**



**Figure 7.6 Saddle Ridge Crossing**

#### 7.8.3.3. Saddle

The saddle type ridge crossing is similar to the parallel and can be used when threatened (Figure 7.6). Turn to parallel the ridge line below the crest until you can use a saddle, canyon, or the end of the ridge to cross to the other side. The exact maneuver is dictated by the terrain characteristics, but can be as easy as a level turn.

### **7.9. Emergencies/Abnormal Operations At Low Altitude**

Emergencies may happen at 500' and below, but you don't "handle" them there. Items such as aircraft malfunctions, bird strikes, disorientation (loss of awareness), lost sight (wingman) and weather deterioration are critical at low altitude and need something such as an "initial move" prior to even looking at the problem. To generalize the handling of unusual occurrences, a response has been developed that covers all problems at low altitude. It is climb to cope. Climb any time you are not coping with your situation. Then, after initiating a climb, maintain aircraft control, analyze your situation, and turn toward the appropriate landing field or continue your mission as appropriate.

### **7.10. Route Abort Procedures**

The best route abort plan is one executed well before the flight encounters IMC. Constantly monitor down-track weather either visually or with snowplow on the radar. If possible, alter the route to maintain VMC. If unable, execute a hook left/right or two 90° turns and allow the previously trailing element the tactical lead until resuming the track. As a last resort, if IMC is encountered, lead should transmit "Viper 1 flight, route abort". At this time, all flight members should turn 30° away from the element mate's last position while selecting AB and establish a 30° nose high attitude. Deselect AB and level off at the RAA/MSA or VMC as appropriate. Squawk EMERGENCY if required or still IMC and follow the briefed reform/abort plan. AFI 11-F16 Vol. 3 contains additional guidance. Large packages require a detailed flight briefing for the desired route abort procedure.

### **7.11. Low Altitude Formations**

Low altitude formations and responsibilities are covered in detail in Chapter 3 of this manual.

---

## **Chapter Eight**

### **NIGHT OPERATIONS**

#### **8.1. Introduction**

The information in this chapter, combined with a thorough knowledge of appropriate sections of MCI 11-F16 Vol. 3 and local procedures, will prepare pilots for safe and effective night flying.

#### **8.2. Physiological Considerations**

With the introduction of new weapons and weapons systems, fighters are flying more at night than in the past. Thus, it's important for pilots to understand the physiological effects of night operations. Areas of primary concern affecting performance at night are circadian rhythm, sleep, and fatigue.

##### **8.2.1. Circadian Rhythm**

Circadian rhythm is defined as the "biological clock", meaning our physiological, psychological, and behavioral functions are subject to periodic daytime-dependent oscillations. When our circadian rhythm cycle is disrupted, we experience biological desynchronization and performance suffers. The most common way to disrupt this cycle is through shift work. This can occur during the occasional night flight, one or two weeks of night flying, or a permanent shift in the flying schedule. Other ways to disrupt the cycle are to withdraw our normal cues to daylight and darkness, and through transmeridian flight such as on a long deployment when we suffer jet lag. The ability to sustain performance is especially important to fighter pilots. Alertness is the major determinant of sustained performance and is influenced not only by man's inherent circadian rhythm, but also by the need for sleep.

##### **8.2.2. Sleep**

While partial sleep loss for any one night might impair performance, repeated partial sleep loss will have a definite impact on performance. Total sleep loss is the absence of sleep for at least 24 hours. This impairs the learning of new information and the recall of newly learned material. Susceptibility to disorientation may increase, scanning ability is reduced, and chart reading ability is affected. Most importantly, judgment and mood are impaired. Irregularity of work and rest over several days is also followed by decreased levels of performance. Combined with recent or cumulated sleep loss, irregular

schedules can be especially fatiguing. Also, the length of the duty day for irregular schedules can further degrade performance. As with partial sleep loss, irregular schedules can increase your susceptibility to the same factors resulting from total sleep loss.

### 8.2.3. Fatigue

Fatigue is tiredness, or exhaustion, from physical and/or mental exertion and is categorized as three types. Acute fatigue is how you feel at the end of a physically/mentally demanding flight. Cumulative fatigue is the tiredness you feel after extended periods of inadequate sleep. Circadian fatigue is the tiredness you feel from having had your routine biological clock disrupted. The consequences of fatigue are degraded performance and less than peak efficiency.

Research has determined that sleep loss and fatigue can lead to complacency, computational/navigational errors, and communication errors:

- Complacency is a sense of well being, often while unaware of potential danger.
- Mathematical and abstraction abilities crucial to accurate navigation, situational awareness, and mission accomplishment are impaired.
- Communications errors occur through miscomputing what you actually hear.

There are preventive measures to prepare for night operations and reduce the inherent risk. They are: adjust your sleep schedule, prepare specifically for the particular night mission, make good use of the OFT, and cancel when you aren't physiologically ready. It is the individual pilot's responsibility to determine preparedness for night operations.

## 8.3. Night Ground Operations

Special care should be taken during night operations. Allow extra time to complete the exterior preflight, since flashlight illumination is minimal. Ensure the canopy is clean. Check the exterior lights during preflight to ensure they are not missing or broken.

The only lights available from battery power are the utility light and the cockpit spotlights. Remove the utility light from its retaining post prior to strap-in. Ensure you are able to monitor RPM and FTIT during start until the generator is on line and additional lighting is available. Use your flashlight if necessary. After start and any other time the aircraft is stopped on the ground (maintenance quick check/arming/de-arming), the position lights should be bright and steady, and the anti-collision strobe should be off. This helps prevent possible ground crew disorientation and gives them better illumination with which to complete their operations. Check the operation of landing and taxi lights immediately after engine start.

When ready to taxi, turn the strobe on, the position lights to flash, and the taxi light on. Taxi at night in accordance with MCI 11-F16 Vol. 3 and local procedures. Because the nose wheel door blocks some illumination of the taxi light (except Block 40/50), visibility to the left of the nose is limited. The landing light may be used during left turns.

## 8.4. Night Takeoff

The night takeoff is essentially an instrument takeoff. The taxi light or landing light may be used. A recommended technique is to set the HUD declutter switch to ATT/FPM for night and/or instrument takeoffs; otherwise, you will lose the HUD attitude ladder when the gear is retracted. Use the HUD/ADI in combination with available visual references (e.g., runway lights) to maintain runway alignment. Establish the climb attitude on the HUD or ADI and perform other procedures as listed under the MIL/AB power takeoff as required. Refer to MCM 3-1 for an expanded discussion of night employment.

## 8.5. Night Formation

Night formations are extremely weather dependent. On clear moonlit nights, formations can be used which are very much like day formations. As conditions degrade, formations must be modified to accommodate reduced visibility and depth perception.



#### 8.5.1. Night Weather Formation

Night weather formation flying requires modification to daytime weather procedures. Anticipate weather entry. The last man in the flight should turn his strobe off prior to weather entry to minimize the possibility of spatial disorientation. Use smooth corrections and avoid rapid or erratic inputs. Lost wingman procedures should be used if you lose visual references.

#### 8.5.2. Fingertip/Route Formation

Flown in the same position as day formation. Since many visual cues available in the daylight may be absent or more difficult to observe, additional care must be taken when flying formation at night.

The night position is the same as the daylight close formation position. Start by aligning the upper wingtip light with the canopy position (formation) light. This places you farther back than normal, so once you settle down in this position, move forward until the canopy position (formation) light, bottom formation light, and position light on the engine intake form an equilateral triangle.

Vertical alignment is within acceptable bounds when you make the inlet position light approximately equidistant between the top and bottom formation light.

When fore/aft and vertical spacing are correct, your head is approximately abeam the floodlight which illuminates your leader's tail or abeam the leader's tail light (just above the nozzle). Avoid fixation on any one light or reference point.

#### 8.5.3. Trail Formations

Trail formations may be flown the same as day formations. However, primary reference for spacing and position will probably be the radar. A technique for monitoring position is to continue normal radar search while maintaining awareness of lead's position near the bottom of the scope. Four to 8 NM spacing with up to 30° offset allows maneuverability and offensive capability without forcing the wingman to dedicate primary attention to radar assessment for maintaining position. In all cases, lead should thoroughly brief desired range and aspect for the wingman's position to ensure formation integrity. The disadvantages of trail formation are the same as day, a loss of visual lookout and visual mutual support.

#### 8.5.4. Lead Considerations

Wingman consideration is critical at night. As lead, configure your exterior lights according to your wingman's desires as much as possible. The anti-collision strobe should be flashing until the wingman has completed his rejoin and then placed in the OFF position. Initially, try a setting of dim/steady for the fuselage and position lights and mid-range for the formation lights. In dim/steady/strobe off, all exterior light toggle switches will be aft/inboard.

Make all maneuvers smooth and coordinated to minimize the possibility of inducing spatial disorientation. Make frequent cross-checks of the wingman's position. If formation break-up is required, do so in straight and level, unaccelerated flight and only after determining that the wingman has operational navigational equipment, understands his position, heading, altitude, airspeed, and clearance. Monitor the wingman closely as the separation proceeds.

#### 8.5.5. Wingman Considerations

Flying the wing position at night presents some of the same difficulties as weather. As such, spatial disorientation will be of special interest. To the greatest extent possible, keep abreast of the situation and plan ahead to predict maneuvers. The primary attitude indicator will be the lead aircraft. Whenever possible, cross-check the HUD or ADI to verify attitude.

The lack of visual cues coupled with inherent depth perception difficulty contribute to the problems of night formation. Use the alignment of the formation lights to maintain fore-aft and vertical position and learn to gauge separation from the size and spacing of these lights. Stay alert for any clearances transmitted or any other indications of imminent changes in flight position, heading, altitude, and airspeed. Be prepared to accept the lead of the flight at any time if required by an emergency or other flight breakup situation. Know the planned instrument recovery and minimums before takeoff. If operations inside the cockpit are required (e.g., radio frequency changes), make slow, deliberate changes

and glance inside the cockpit briefly to check the results. Don't take your eyes off the lead aircraft for any extended period of time.

## **8.6. Night/Weather Intercepts**

Night or weather intercepts present a unique challenge since, in addition to flying good instruments, you must include the radar in your instrument cross-check. Primary consideration must be given to maintaining aircraft control by instruments, and very little time (if any) should be devoted to outside visual references or attempting to get a tally. This is contrary to what you learned during your day VMC intercept missions. Attempting to attack another aircraft at night or in the weather is demanding and can be spatially disorienting; especially in the F-16.

### **8.6.1. Cockpit Setup And The Bubble Canopy**

It is important to have the cockpit and switches set up as early as possible. This helps you stay ahead of the jet. Set up cockpit lighting as low as comfortable. Use caution to ensure you do not lower contrast too low and cut off target histories. The pilot must compensate for the F-16's vertigo-inducing effects with good head-down instrument flying.

### **8.6.2. GCI**

At night or in weather, GCI control can be of great value, but be aware of their limitations. Pay attention to the controller's instructions. Remember, your radar situational awareness provides an accurate way to update information.

### **8.6.3. Altitude**

Altitude separation from the target should be reduced during night/IMC to avoid large pitch changes at the merge. Usually 2000' to 4000' above or below the target is sufficient. Continually monitor your altitude during all phases of the intercept. This helps to avoid deviations which could violate the target's altitude block or impact with the ground.

### **8.6.4. Auto-Pilot**

This may be used, but constantly monitor its performance. Remember, it will not maintain altitude at high AOA/slow airspeed. No warning occurs if it is not holding your altitude.

### **8.6.5. Turns**

In night/weather conditions, make all turns at the lowest G that's appropriate. When making turns, concentrate on aircraft control and do not allow yourself to be distracted with radar, GCI, or other inputs. One technique is never use more than 60° of bank without full attention on instrument flying. At night, increase lateral displacement so that the final turn is colder. Throughout the intercept, keep the aircraft stabilized as much as possible in altitude, airspeed, and bank angle so that you don't become preoccupied with large corrections back to the desired parameters. This will allow you more time to analyze the radar and basic intercept geometry.

### **8.6.6. Instrument Cross-Check**

It is tempting to rely on occasional outside visual references and other unreliable sensory cues rather than on instruments to maintain aircraft attitude. While the consequences of this approach to instrument flying in weather are generally understood, you may not fully appreciate how unreliable sensory cues and outside visual references can be for assessing aircraft attitude when flying the F-16 at night or IMC. Large and often insidious changes in aircraft attitude, altitude, and airspeed can go undetected, unless there is frequent reference to instruments.

### **8.6.7. Sitting Heights**

Consider a lower sitting position at night. A high sitting position requires you to look well down into the cockpit to check instruments. The head movements made between HUD references and cockpit instruments can contribute to spatial disorientation. Your primary means to fly the night/IMC intercept **must** be via instruments.

#### 8.6.8. Head-Up Display

Since some basic attitude information and almost all weapons information is displayed on the HUD, it may be tempting to allow too much time to the HUD cross-check at the expense of a basic instrument scan. This, in turn, may tempt you into noticing/searching for outside visual cues. While use of the HUD may be helpful, do not let it become distracting.

#### 8.6.9. Afterburner

If selected, the rapid acceleration can cause a distinct impression of climbing. Selection of the afterburner in weather will sometimes cause a startling bright flash. The use of AB at night will also highlight your position.

#### 8.6.10. Lost Contact

A lost contact during the intercept should not be a cause for hasty or improper action. The first priority (as always) is to maintain aircraft control and ensure proper altitude separation. Don't be reluctant to skip it, knock it off, or blow through if situational awareness or other circumstances dictate. If you elect to continue the intercept, reestablish GCI control by calling for "bogey dope" and request close control, until contact is regained. If outside 10 NM with no contact, consider dragging. Inside 10 NM, go slewable ACM and bracket the target's last known altitude. If in the conversion turn when contact is lost, ease off the turn (or roll out momentarily) to ensure you will end up behind the target and remain in your block. Then turn to the last known target heading and begin searching for the target with radar (if you can confirm the target is not maneuvering).

**WARNING:** DO NOT drive (for long) on any heading other than the target's and DO NOT use visual references in an attempt to save the intercept. This invariably results in large altitude/attitude deviations, seldom saves the intercept, and often leads to spatial misorientation.

#### 8.6.11. Visual Reference Considerations

The tendency to use the HUD as you would in a visual attack can be unsafe during night or IMC. Some reasons for this are:

- You don't know if you're looking at the real target or just some "other" light.
- You can't judge range and closure rate.
- You may be visually maneuvering your jet into an unusual attitude. (Furthermore, a real target will not have his beacon on at night!!) You must perform frequent instrument cross-checks during night/IMC intercepts. The emphasis should be on **instruments** until approaching weapons launch range.

### 8.7. Night Surface Attack

Preparation for flying night missions, especially night surface attack, demands thorough and accurate planning. All of the normal items required for daytime operations need to be accomplished and double checked for accuracy. Errors which you might easily catch in flight during the day can mislead you at night, and go undetected for too long. Be sure the INS and weapons data are good. In addition to the usual items, you will want to review the following subjects:

- Aircraft interior lighting.
- Aircraft exterior lighting.
- Emergency lighting (generator failure).
- Night visual signals (radio out).
- Alternate airfield night lighting.

#### 8.7.1. En Route Procedures

Route of flight and en route procedures will vary in accordance with local procedures. Your route to the range may include a night air refueling, a night low level, or simply be a medium altitude direct route. Procedures at night are similar to daytime with the following exceptions:

- Visual ordnance checks are not made at night.
- Formation position changes are directed over the radio.
- Low level routes are flown at higher minimum altitudes (see MCI 11-F16 Vol. 3).

#### 8.7.2. Range Layouts

The specific layout of night ranges vary with each local range. Three of the more common layouts are shown in Figures 8.1, 8.2, and 8.3. Refer to the local supplement to AFI 13-212 to determine which type of lighting your range has. The individual marking devices could be either flare pots, lanterns or electric lights. Most ranges use flare pots on the "bull" since it is likely to take numerous hits.

No matter which type of ground illumination is used, the intensity of the markers is normally quite dim. In addition, some of the lights may be out for various reasons. These factors can combine to make it difficult to distinguish the target from other lights in the area. Each range has its own peculiar set of false lights and illusions. Positive identification of the target is absolutely essential, so be sure you know exactly what to look for.

On a real "dark night" you may have to maintain your position by reference to target area lighting only. Realize that the array of lights around the target will have a different appearance depending on the angle at which you view them. Other lights which may help maintain orientation are the obstruction lights on the main and flank towers. These lights should be distinguishable by their different color (red).

If flare support is available from another aircraft, your job of seeing the range/target area can be vastly simplified. However, you may have to find the range on your own prior to the flareship dropping any flares.

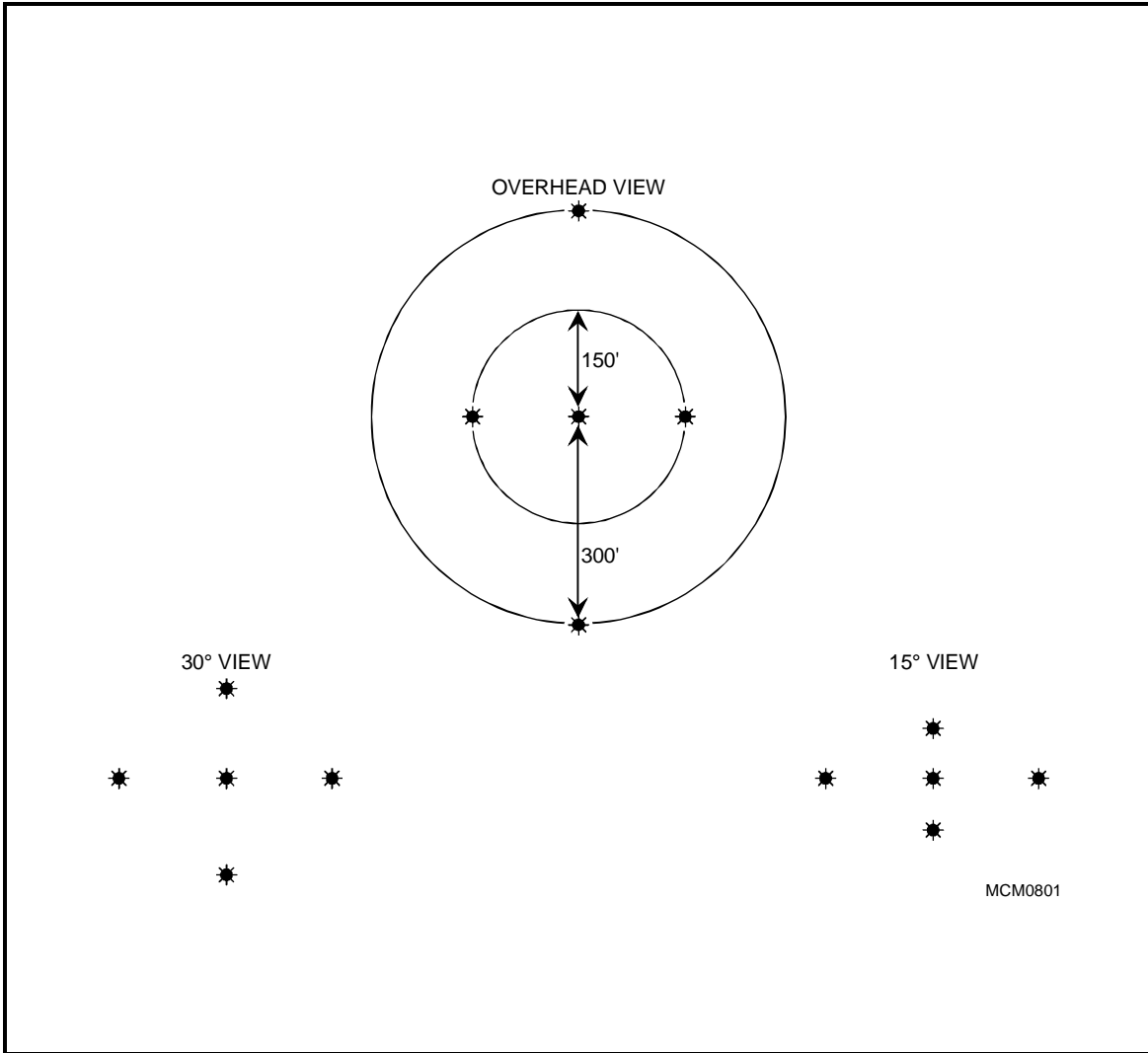


Figure 8.1 Typical Night Ground Illumination - 1

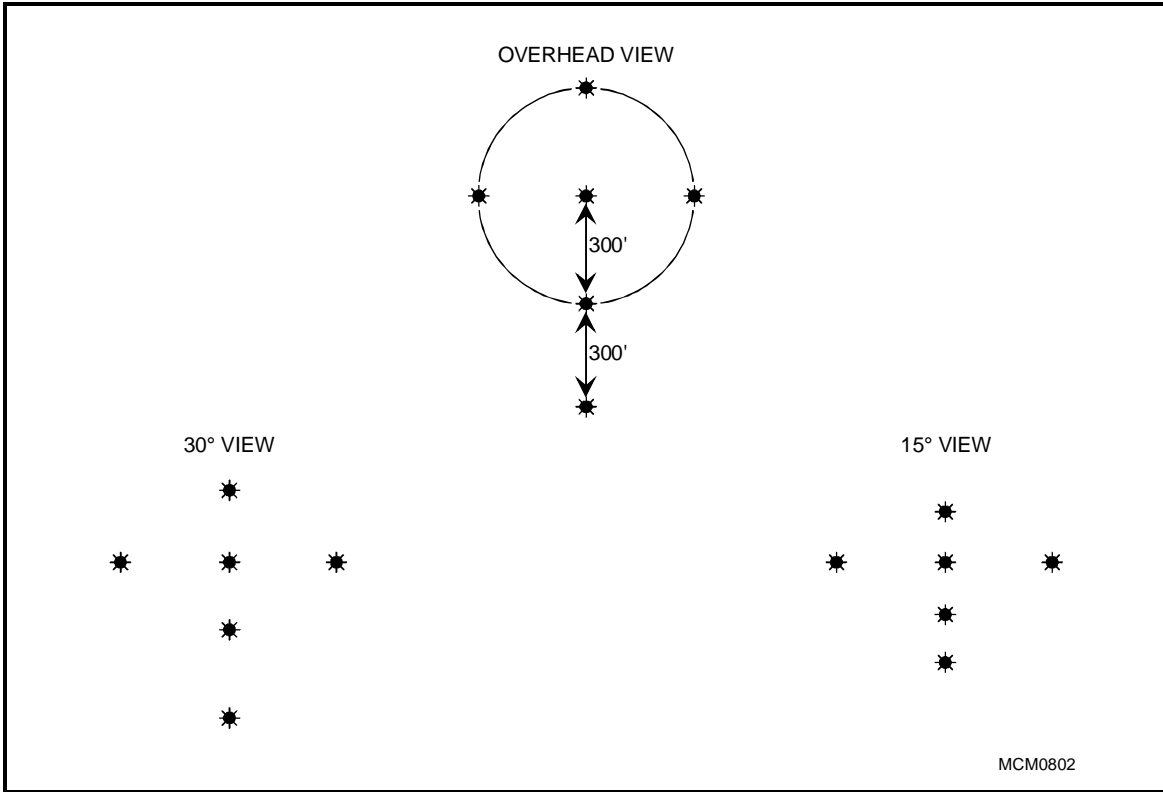


Figure 8.2 Typical Night Ground Illumination – 2

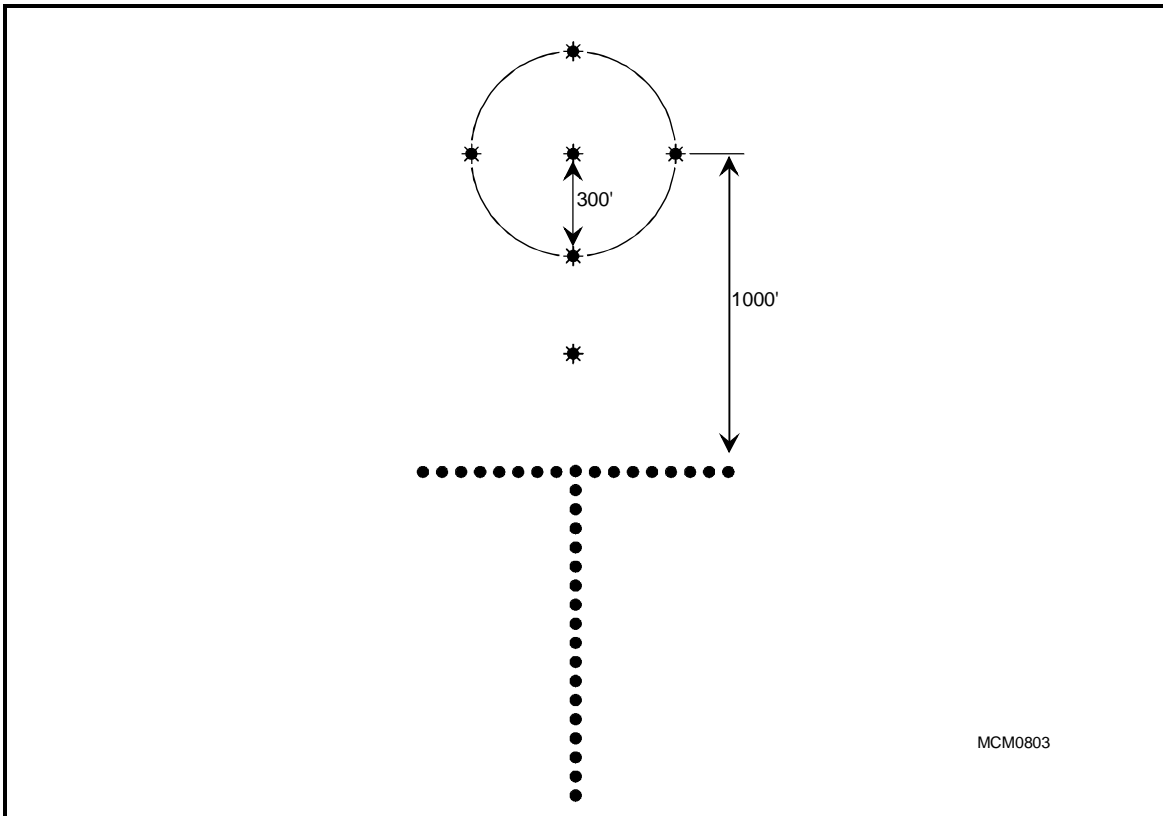


Figure 8.3 Typical Night Ground Illumination – 3

### 8.7.3. Range Entry Considerations

Getting clearance on the range is similar to daytime operations, with certain additional requirements:

- Clearance must be received from the RCO who must ensure deconfliction between the fighters and any flare support aircraft. This is normally done by altitude separation.
- A maximum of three aircraft will be allowed in the pattern (one may be a flareship).
- Target identification is often difficult and the RCO may be needed to help direct the flight to the range.

It is common to enter the night range pattern from a nonconventional delivery pass. Night nonconventional procedures are similar to day with the following exceptions and special considerations:

- Minimum run-in altitude should be the same as night low level navigation. Call "final, event, altitude" at the IP.
- Minimum downwind altitude is 1500' AGL (AFI 11-F16 Vol. 3).
- Nonconventional targets do not have to be illuminated at night.

Strict discipline with respect to maintaining proper altitude, heading, and speed is critical. There are many tasks to be performed in the cockpit in order to make a radar delivery but the most vital ones are maintaining aircraft control and not hitting anything. You simply cannot afford to spend any extended period of time doing things like reading a map/checklist, or adjusting the radar gains, without cross checking your instruments. Good preflight planning, to include the pacing of your tasks, will go a long way toward minimizing misprioritization.

Just as in daytime, the autopilot can be useful in maintaining altitude while freeing your hands for other tasks. However, **THE AUTOPILOT MUST BE MONITORED**. Always check the function after you turn it on and ensure that you are in the altitude hold function of the autopilot. There are several failure modes of the autopilot which do not give warning to the pilot.

### 8.7.4. Foul Avoidance

The range officer's judgment of foul parameters is impaired by darkness. He may foul you prematurely, or even worse, he may fail to foul you when you really deserve one. Fly your airplane like a professional and neither one will happen.

- Planned deliveries exceeding a 30° dive angle will not be flown.
- Night controlled range minimum recovery altitudes are as follows:

<u>EVENT</u>	<u>MINIMUM RECOVERY ALTITUDE</u>
30° dive	2000' AGL
15° - 20° Low Angle Low Drag	1000' AGL

### 8.7.5. The Night Box Pattern

Essentially, the night attack patterns on a controlled range are the same as those flown in the daytime. Because of visibility restrictions, a slightly larger pattern is recommended.

#### 8.7.5.1. Spacer Pass

The spacer pass may be flown from a standard formation pass over the target, or it might be from a simple pitch up to downwind from a nonconventional pass. No matter how you split up, it is critical that you take the prebriefed spacing and pitch up in a manner that does not immediately induce vertigo. Use about 45° - 60° of bank and 2 - 3 G's in the break. Have your HSI set up with a reference on the run-in heading so that you can quickly assess your heading with respect to the pattern headings. The night pattern should be flown much more "mechanically" than in the day.

#### 8.7.5.2. Crosswind

When turning crosswind any time in the night attack pattern, there is a stronger chance you will turn inside of the preceding aircraft. Rolling out wings level momentarily (3 - 5 seconds), and looking outside

as well as inside your turn, will help to avoid passing or colliding with other flight members. In addition, this momentary roll out will aid in keeping the pattern from becoming uncomfortably tight.

#### 8.7.5.3. Downwind

Daytime considerations apply. Avoid the "moth effect"—tendency to allow the pattern to gradually become tighter and tighter around the small, well-lit target area. All switch changes will be accomplished wings level on downwind. Turn position lights to bright-flash, strobe light on, and formation lights full bright (IAW AF and 55 series directives).

#### 8.7.5.4. Base

Determine the required base leg distance from the target for the particular event being flown. Exact base leg position is harder to fly at night since you do not have the normal daytime ground references. Here are some commonly used techniques:

- Time your downwind leg from a point abeam the target. Time approximately 6 - 8 seconds from the point abeam the target. Start a 2 - 3 G turn to base at the end of this time.
- Use the same angular relationship of the target position over the canopy rail as you do in the daytime. *CAUTION:* Be sure you are wings level. A shallow bank into the target will cause you to angle-in.
- Reference to the length of the lighted "T," or other run in markers, (if available) will help get your distance out correct.

#### 8.7.5.5. Roll In

Night roll in is similar to daytime, except that you need to cross-check attitude instruments to avoid getting disoriented. There is a tendency to undershoot final on the first few patterns. Reference the lighting on other objects, such as the range/flank tower to give the idea of when to begin the roll in. All night patterns will be basic versus tactical deliveries.

#### 8.7.5.6. Final

At night, place additional emphasis on the parameters of each pass (dive angle, altitude, airspeed).

#### 8.7.5.7. Recovery

Recover so as not to descend below minimum recovery altitudes, regardless of whether your ordnance is away or not. Strict attention to cockpit instruments is of paramount importance. Initiate recovery using a wings level 5 G pull up and do not initiate turns until the aircraft nose is definitely above the horizon. Attempting to observe your own bomb impact is **extremely dangerous. Don't do it.**

#### 8.7.6. Night range radio procedures

The need for strict radio discipline increases dramatically in the night range pattern. The following radio calls and location that are to be made are mandatory:

- When directly abeam the bomb circle, transmit: **"Two, downwind"**
- Starting the turn onto base, transmit: **"Two, base"**
- As you start the turn onto final, transmit: **"Two, in"** (Add **"flare ship in sight,"** if required).
- During recovery, transmit: **"Two, off wet"** or **"Two, off dry"**

The additional radio calls in the night pattern increase the chances of blocking out the two most important calls which are the call "in" by the aircraft turning final and the clearance call by the range officer. If necessary, delay other calls when you sense these two calls are about to take place.

#### 8.7.7. Night Range Departure Procedures

With a few minor exceptions, the night range departure is similar to the day procedure. Ordnance checks are not required at night. Check your unit standards. If you recover as a formation the following guidelines apply:

- Wingmen will acknowledge the number of aircraft in sight.
- Avoid dropping low during the rejoin.



- Expect lead to roll out.
- Lead will transmit exact heading and altitude.
- Wingmen will join in order.

#### 8.7.8. Night Computed Bombing

Computer assisted bombing in the F-16 makes it possible to deliver ordnance accurately even though parameters may have been a long way from accurate. Attention to parameters is important in order to avoid fouls and get actual bomb release near the desired altitude.

Because of the large reflective canopy of the F-16, nearly all of the bright spots inside the cockpit will reflect inside. These can distract your attention and make it hard to distinguish dimly lit ground targets. Keep your console and instrument panel lights at the minimum which will still allow you to read them.

Find an optimum HUD brilliance level that suits the prevailing atmospheric condition and your individual vision. An overly bright HUD may not seem like a problem until you experiment and reduce the brilliance at which time the target may become much easier to see.

(APG-66) Radar display intensity can be very tricky. It must be set up through all three controls: intensity, contrast, and symbology. Since the radar display is not used in visual bombing you may want to simply turn the intensity down until it is nearly black while you work the range. The best radar display picture can be obtained by turning down the "contrast" first, then adjusting the other two controls. The night filter, if available, helps to solve these display problems.

(APG-68) The night SBC reset function makes initial night setup easy and only minor adjustments will be necessary for air-to-air operation. However, if GM is selected, the MFD intensity will be well above a useable level and gain/brightness/contrast should be readjusted. Attempt this initial adjustment prior to takeoff if possible using the shades of gray displayed during the radar BIT check.

The preferred mode for night visual surface attack is CCIP. The DTOS mode can also be used, but it is better suited to long range, high altitude deliveries. CCIP offers the inherent advantage that the bomb fall line always points down; perpendicular to the horizon. Although you can still get the "leans" trying to steer out the pass, as long as the pipper is at the bottom of the HUD then pulling G will move the nose up. Thus the CCIP symbology acts like an attitude indicator and aids in maintaining orientation. CCRP is the preferred delivery mode for targets which cannot be visually identified at night. The decision to accomplish level or loft deliveries should be based on desired delivery altitude, weapons effect, and target area considerations.

When you roll out on final you will have to rely solely on the HUD cues to establish an aim-off point and pipper placement. If you are accustomed to using a visual aim-off point on the ground, it will probably not be visible at night. Thus you will need to roll out with the target about 1/2 - 2/3 the way down the bomb fall line. There is a strong tendency to pull the CCIP pipper up to the target and release high. While this technique is safe it is not necessarily desirable because it causes larger miss distances. A controlled pass with release occurring at or near the preplanned release altitude is best. Do not over compensate for this tendency and press below planned release altitude. Above all, any time you feel uncomfortable, or you lose awareness of exactly where you are, pull out. DO NOT PRESS.

#### 8.7.9. Flare Procedures

Although the F-16 is not certified for carriage of MK-24 flares, you may have a chance to drop using flares released by other aircraft. Flares are used for night close air support and other missions where complete illumination of the target is required. Flare illumination makes it possible to fly by visual reference to the ground for attitude control, but a continual instrument cross-check is necessary, especially during recovery, changing armament switches, or when vertigo is suspected.

The LUU-2 flare will burn for 5 minutes and produce illumination rated at 2.0 million candlepower. A normal value for flare coverage is a circle with a 1 NM diameter. The flare descends 500-600 feet per minute. Directly beneath each burning flare, there is an area of subdued light caused by design characteristics. When two flares are dropped, the light overlaps and brightens the area of reduced intensity directly underneath each flare. Flares normally burn out at approximately 500' to 1000' AGL.

Attack conditions become marginal after the burning flare drops below 500' AGL due to the area of subdued light directly beneath the burning flare.

Sky and atmospheric conditions have a serious effect on the quality of flare illumination.

Low ragged overcast, fog, haze, or drizzle will cause flare light to be diffused and less effective. The probability of spatial disorientation is increased. Highly diffused light generally means no visible horizon and few orienting ground references; the total "world" is centered around the flare which creates a three-dimensional sphere of light. This is referred to as the "milk bowl effect." Difficulty may be encountered in determining the aircraft's attitude and the vertical might appear to be in the direction of the flares. Use of flight instruments cannot be overemphasized.

Flares burning under a medium or low overcast with good visibility will produce added light due to reflection. However, reflection can also produce deceiving perception problems. From a tactical standpoint, an aircraft is easily silhouetted against an overcast sky and readily discernible by enemy gunners.

Clear weather, with moonlight and some ground illumination, provides excellent conditions for flare lighting, and attacks can be executed with minimum reference to flight instruments.

There is an apparent haze layer at the altitude of the burning flare. In a dive, as the aircraft approaches the flare's altitude, visibility becomes restricted; target and ground acquisition become more difficult. This problem can be reduced by releasing above or below, not level with, the burning flare.

Flying below the altitude of burning flares is unwise but at times cannot be avoided. Extreme caution should be used as the flare may appear to be at a reasonably high altitude when actually it is on, or close to, the ground.

The pilot must avoid any flares that drift into the approach path. Flares, as obstacles, usually generate a restriction to attack direction. Avoid the area six o'clock low to the flare ship. The pilot dispensing flares will offset accordingly for range wind and crosswind.

There will be approximately a 20 to 30 second delay from the radio call of "flares away" until you actually see the flares. Approximately 15 seconds are required for flares to reach maximum intensity after ignition. Observing night minimum recovery altitudes should keep you safely above spent flares. However, on some occasions, these empty flare chutes, referred to as "ghosts," will ride thermals. They will be near or even above burnout altitude and downwind of the burnout point. Avoidance of these nearly invisible hazards is important during ordnance delivery and recovery. Also unseen, more dangerous, but less prevalent, are unignited flares suspended in their chutes. This type of dud (occurring at a rate of 12% - 15%) is always found below the ignited flares since it descends faster than an ignited flare. Avoid a dud flare by counting the lit flares and remaining above the altitude of the ignited flares dropped on the same pass.

The range officer, upon hearing the flare pilot state the number of flares released, will have the primary responsibility for calling out dud flares. He should also notify the flight of any flares burning on the ground. Flight members will assist in calling out the locations of hazardous flares. When the position of the lighted flares in the group indicates that the dud flare is in the proximity of the final approach, the pass will be aborted. The range officer will cease operations any time he considers flares to be a hazard to safe flight.

### **8.8. Night Landing**

Night landings are normally made from a precision approach. The approach should be flown the same as in the daytime. However, at night and in weather, the landing light may cause a distraction if it reflects off of the clouds. In this case, the landing light may be turned off until on short final. The landing light provides adequate reference for a normal landing. HUD intensity may have to be adjusted to adequately view symbology while still affording a clear view of the runway environment. Follow guidance in AFMAN 11-217 for landing out of instrument approaches and avoid the tendency to visually "duck under" the desired glide path. Visual references can be deceiving at night.

### 8.9. Night Refueling

Night refueling procedures are basically the same as day procedures, but standard night flying considerations apply. At night, you must be smooth to avoid inducing spatial disorientation. Perform the rendezvous like an IMC intercept, relying on GCI and your radar to complete the rendezvous. In the observation position, the forward nacelle light on the tanker may be distracting. Request the tanker to dim this light or fly a formation position that blocks the light with the tanker's wingtip. If any other light bothers you, ask the tanker to turn it off or down. As a courtesy, avoid making such requests when another flight member is on the boom. Precontact, contact, and post-contact procedures remain unchanged. Be prepared to transition to instrument flight if visual contact with the tanker is lost (lost wingman).

### 8.10. In-Flight Distress Signals--Night Visual (AFI 11-205)

The following in-flight distress signals (night visual) will be used only when the radio is inoperative and will be acknowledged by a steady light.

*Aircraft Emergency (Must Land As Soon As Possible):* Signal escort aircraft by repeated intermittent flashes with a flashlight, then assume the wing position—this signal indicates a jet approach speed of 130 knots. If a higher approach speed is desired, the pilot must pause after the basic signal and then blink his flashlight at the top of the canopy—once for each 10-knot increase desired. The escort pilot will lead to the nearest suitable field, declare an emergency with the controlling agency, then fly a straight-in approach with the aircraft on his wing. The distressed aircraft lands and the escort executes a go-around. On a straight-in approach, the escort aircraft turns his position lights to BRIGHT/STEADY to alert the wingman to prepare to lower landing gear. The corresponding signal of execution will be for the escort aircraft to return his position lights to DIM/STEADY. If the aircraft is only equipped with a STEADY-BRIGHT light position, it will blink the lights for the alerting signal and for the execution signal.

*Attention:* Attention should be attracted by whatever means of illumination are available (e.g., flashlight, position lights on-off, etc.).

*Change Lead:* Pilot of distressed aircraft holds flashlight parallel with canopy rail and sends a steady light while making a straight line from rear toward the front of the canopy.

*Complete Electrical Failure (No Assist Aircraft Available):* Procedures the same as day visual signals.

*Descent To Lowest Practical Altitude:* The pilot makes a rapid vertical movement with a flashlight.

*Radio Inoperative (No Assist Aircraft Available):* Follow day radio inoperative procedures.

*Signal Acknowledgment:* Point a steady light from the flashlight at the signaling aircraft.

*Night Approach-End Barrier Engagement Without Radio:* Fly parallel to the active runway, 1,000' AGL, flashing the landing light. Proceed as with day approach-end barrier engagement without radio.

---

## Chapter Nine

### PROFICIENCY EXERCISES

#### 9.1. Introduction

This chapter serves as a guideline of various proficiency exercises. These exercises are grouped into four sections: G-awareness training, aircraft handling exercises and maneuvers, fighter proficiency exercises, and low altitude training exercises. A discussion of simulated flameout (SFO) approach considerations is also included.

#### 9.2. G-Awareness

G-induced loss of consciousness (GLOC) is a serious problem. Contributing to the severity of this problem is the inability to accurately and reliably assess pilot G-tolerance and G-endurance. AFPam 11-404, *G-Awareness for Aircrew*, provides comprehensive information on the physiology of G-awareness.

### 9.2.1. G-Tolerance

G-tolerance can be thought of as the ultimate G level that can be maintained over a short period of time that still allows the pilot to employ the jet safely and effectively. However, if action isn't taken to either improve the AGSM or reduce the G load, rapid progression to GLOC will occur. G-tolerance is highly variable and dependent upon numerous additive factors.

### 9.2.2. G-Endurance

G-endurance, the max G level that can be maintained over a longer period of time, is perhaps more important; especially considering the F-16's capability to sustain high G. G-endurance is highly dependent upon physical conditioning and "G-currency". Centrifuge studies have shown that layoffs of even a few weeks will result in significantly reduced G-endurance even though G-tolerance remains essentially unchanged. It is easy to see how this increased gap between G-tolerance and G-endurance could set a pilot up for GLOC.

### 9.2.3. G-Awareness Exercise

A dedicated G-awareness exercise should be conducted when required IAW AFI 11-214. The key to GLOC avoidance is pilot awareness; the pilot alone has the ultimate control over G-stress factors. For this reason, the G-awareness exercise is designed to heighten pilot awareness of the man-machine interface and the G-stresses of the mission at hand. As a minimum, the G-awareness exercise should be flown as follows:

- Establish adequate aircraft separation and airspeed to allow tactical maneuvering.
- Self-test the G-suit system for proper inflation, mindful of proper connections and leaks in the system.
- Film the exercise in HUD (if so equipped) and in hot mic.
- With a smooth application of G (as in a tactical turn), perform a 4 - 5 G turn for 90° (level to climbing). Use this opportunity to ensure proper operation of the G-suit and practice the timing and coordination of your anti-G straining maneuver.
- Reestablish airspeed and perform another 90° (air-to-ground)/180° (air-to-air) turn. Turn initially with 5 - 7 G's and then let off to a minimum of 3 - 4 G's during the last 90° as energy bleeds off. Again use this opportunity to establish your awareness for operating in the increased-G environment while practicing the anti-G straining maneuver.
- If aircraft limits or energy limits preclude completing the above at the prescribed G, then turns should be performed so as not to exceed aircraft limits.

### 9.2.4. G-Awareness Summary

The G-awareness exercise is not, nor is it meant to be, an assessment for G-tolerance or G-endurance. Nor can this exercise protect the you from GLOC. It can only afford the opportunity to test equipment, practice the anti-G straining maneuver and bring the G environment to the forefront of your mind. G-awareness is a mindset, not a set of exercises to be done and forgotten. G-awareness must be practiced and observed throughout the mission. Remember GLOC incidents typically do not occur during canned "G-Awareness Exercises" when aircrews are physically and mentally prepared for the onset of G's. They occur when pilots channelize their attention on some other facet of the mission, such as threat reactions, and place themselves in the high-G environment without preparing their bodies to do so.

## 9.3. Anti-G Straining Maneuver (AGSM)

The L-1 AGSM is the best G-defense measure available to aircrew members. Equipment measures (Anti-G suit, combat edge, reclined seat, etc.) were never meant to replace the AGSM, only aid it. The AGSM must be properly performed by pilots in order to gain maximum benefit. It is imperative to realize the L-1 AGSM should be performed under all G loading, only the intensity of the L-1 should be varied to match the particular G load. The intent is to ingrain into the subconscious the ability to automatically apply the proper L-1 AGSM anytime G loading is applied or anticipated. This will build the instinctive reaction required by your body to ensure you do not get caught behind the G loading and become a GLOC statistic. Additionally, an instinctive, properly executed AGSM will serve to benefit you with increased

combat capability as it allows you to max perform your aircraft in the combat arena. It is also your best defense against fatigue that will degrade your performance and make you even more susceptible to GLOC on your next engagement.

### 9.3.1. Performing the AGSM

The AGSM consists of two components, muscle tensing and chest straining which must be performed simultaneously. Performing one without the other may significantly reduce the effectiveness of the strain. The following is a description of an effective L-1 AGSM:

Anticipate the G. Take a deep breath, close the throat, and tense all abdominal, arm, and leg muscles for a 3 second time period. Then take a quick breath every 3 seconds (the exhalation-inhalation phase should be no longer than .5 to 1 second). Minimize comm and don't relax until the G is really unloaded.

Muscle tensing increases usable blood volume and return of blood to the heart. All leg, arm, and abdominal muscles must be tensed to reduce the space in which blood may pool. The tighter (more tense) the muscles, the greater the reduction in the tendency for blood to pool. The legs are most important. Tensing of all skeletal muscles, especially abdominal, helps to "push" blood back to the heart.

It's important to maintain muscle tightness throughout the G-load. The muscle strain intensity may be varied depending on the G-load, but the tenseness must continue as long as the G-load is maintained. The muscle strain must be maintained continuously, even when breathing. If the muscles are relaxed while still under G, the blood will immediately rush into the extremities making it almost impossible to catch up if at moderate G (4 - 5) or higher and may even result in almost instantaneous GLOC.

An effective AGSM increases heart output pressure. It works as a "boost pump" for the heart. The greater the pressure generated in the chest, the more the heart and blood vessels leading from it are squeezed, and the greater the resultant blood pressure. This keeps brain blood pressure in the functioning range.

The breathing cycle can be described as follows: Take a deep breath prior to the onset of G, close the glottis (throat), and bear down with the chest muscles as in trying to exhale, but keep the throat closed. This process will generate the pressure. Every 2.5 - 3.5 seconds take a breath. Only exhale about 30 - 40% of the air. Immediately pull the air back in and regenerate the chest pressure. Ideally, the exhalation and inhalation process should take about 0.5-1 second. Minimize comm during G (you can't talk and hold your breath at the same time).

### 9.3.2. Common Errors in Performing the AGSM

- The biggest error is failure to apply the proper knowledge of the AGSM technique while integrating it into other flying skills. The AGSM must be consciously practiced correctly in the jet until its performance becomes automatic and correct. This takes a lot of discipline and practice.
- A very dangerous error is developing good chest pressure while failing to tense the rest of the body musculature. This causes the blood to pool in the extremities and the overpressure in the chest impedes the return of blood to the chest. Result can be GLOC or severe visual loss at best, depending on the G.
- Failure to anticipate the G. Performance of the AGSM should begin, ideally, just before the aircraft is loaded. Failure to do so will result in the aircrew member either trying to catch up on the AGSM (a very dangerous practice) or having to unload in order to buy time to catch up.
- Failure to maintain chest pressure (loss of air). Occurs while talking or whenever the strain is audible. As air is lost from the chest the amount of pressure generated falls. This directly reduces blood pressure to the brain. If air loss is heavy, as might occur with speech, the subsequent loss of blood pressure in the brain may result in GLOC without the prior warning of visual loss. Other causes of air loss are "groaning" (letting the air escape slowly) and trying to hold the chest pressure by sealing the lips rather than with the throat.
- Holding the breath less than the required 2.5 - 3.5 seconds results in lower average blood pressure in the brain than would be obtained otherwise (G-tolerance is reduced) and fatigue is accelerated.

- Holding the breath longer than 3.0 seconds. The increased chest pressure impedes return of blood to the chest where it is available to the heart. If blood return to the chest is blocked for 4 - 5 seconds, the heart may run out of blood to pump. The result is a rapid or precipitous drop in blood pressure in the brain with high potential for GLOC.
- Exhaling too much air while under G, particularly common during rapid onset. Results in a reduced ability to develop chest pressure and may significantly shorten the breath-holding time to less than 2.0 seconds.
- Taking too long to complete the exhalation and inhalation cycle. During the time chest pressure is absent, blood pressure at the brain may drop to zero. GLOC does not occur as long as the blood supply is not interrupted for too long. However, if the blood flow is interrupted too many times for as much as 2 - 3 seconds, GLOC potential is markedly increased.
- Performing a strain with the intensity necessary to stay awake at 9G, but the G load is only 5G. This will result in early fatigue and increased potential for GLOC in subsequent engagements. The intensity of the AGSM may be graduated in relation to the level of G. It is always safe to overestimate the intensity of the strain, it is always unsafe to underestimate the intensity required. Ideally, the intensity of the straining maneuver will match level of G.

### 9.3.3. AGSM Assessment

Assess the AGSM effectiveness during mission debriefings. This assessment should not be limited to the G-Awareness Exercise. It is imperative to evaluate the AGSM after the pilot has had time to fatigue, as this is usually when the AGSM breaks down and GLOC occurs.

Fly the tactical portion of all basic missions (BFM, SA, ACM, etc.) in hot mic to enable assessment of the AGSM. Intercom volumes should be set at a level which is comfortable for the aircrew, but still allows assessment of breathing and AGSM technique in the debrief. For high task sorties (DACT, composite force, opposed SAT, etc.), it is highly desirable for aircrews to fly in hot mic. The purpose is to identify breakdowns in the AGSM which commonly occur during high task portions of a mission.

- HUD should be selected with camera "ON" (if applicable).
- Listen for a preparatory inhalation just before or as the G is loaded. If it is not there, the pilot may already be behind the G.
- Listen for exhalation sounds or talking during the G-onset. This signifies loss of air from the chest and reduced efficiency of the strain and G-tolerance. Additionally, the pilot is likely to be behind the G and will have trouble catching up. This may cause the pilot to either unload some of the G or sharply increase the intensity of the strain (usually audible). The latter may be a result of recognition of vision loss. Ideally, the first breath should be held until the desired G-level is reached or 3 seconds, whichever occurs first.
- Listen for the first exhalation. It should be short and immediately followed by a quick inhalation. The end of the inhalation may be noted by a sudden grunt sound or a sudden absence of breathing sounds. Total time for the breath ideally should be 0.5 seconds, but in no case should be longer than one second.
- If breath intervals are greater than 3.0 seconds, return of blood to the chest may be impeded reducing G-tolerance. If breath intervals are 4.0 seconds or longer, there is a high risk of GLOC.

Ideally, after the inhalation, breath sounds should not be heard for 2.5 - 3.5 seconds. If breath sounds are more rapid, average chest pressure is lower and G-tolerance is negatively affected. As G-tolerance is negatively affected, the pilot will have to work harder at any given G-load. Fatigue during the engagement, or especially in subsequent engagements, will most likely become apparent. This may be evidenced by even more rapid breathing or breathless, gasping sounds. Observation of the G-load at these times may provide evidence that the pilot is apparently working too hard for the G or is unable to maintain the G necessary for the tactical situation.

Talking at G may be hazardous depending on the individual and the G-load. If talking is required, it should be in very short bursts accomplished during the breathing phase of the AGSM. However, the need to talk should be weighed carefully against the need to stay awake.

#### 9.3.4. AGSM Summary

Remember, the same AGSM should be performed anytime G is applied, only the intensity of the maneuver is varied. Therefore, the AGSM should also be assessed under relatively low intensity G such as air-to-surface sorties.

#### 9.4. Aircraft Handling Exercises and Maneuvers

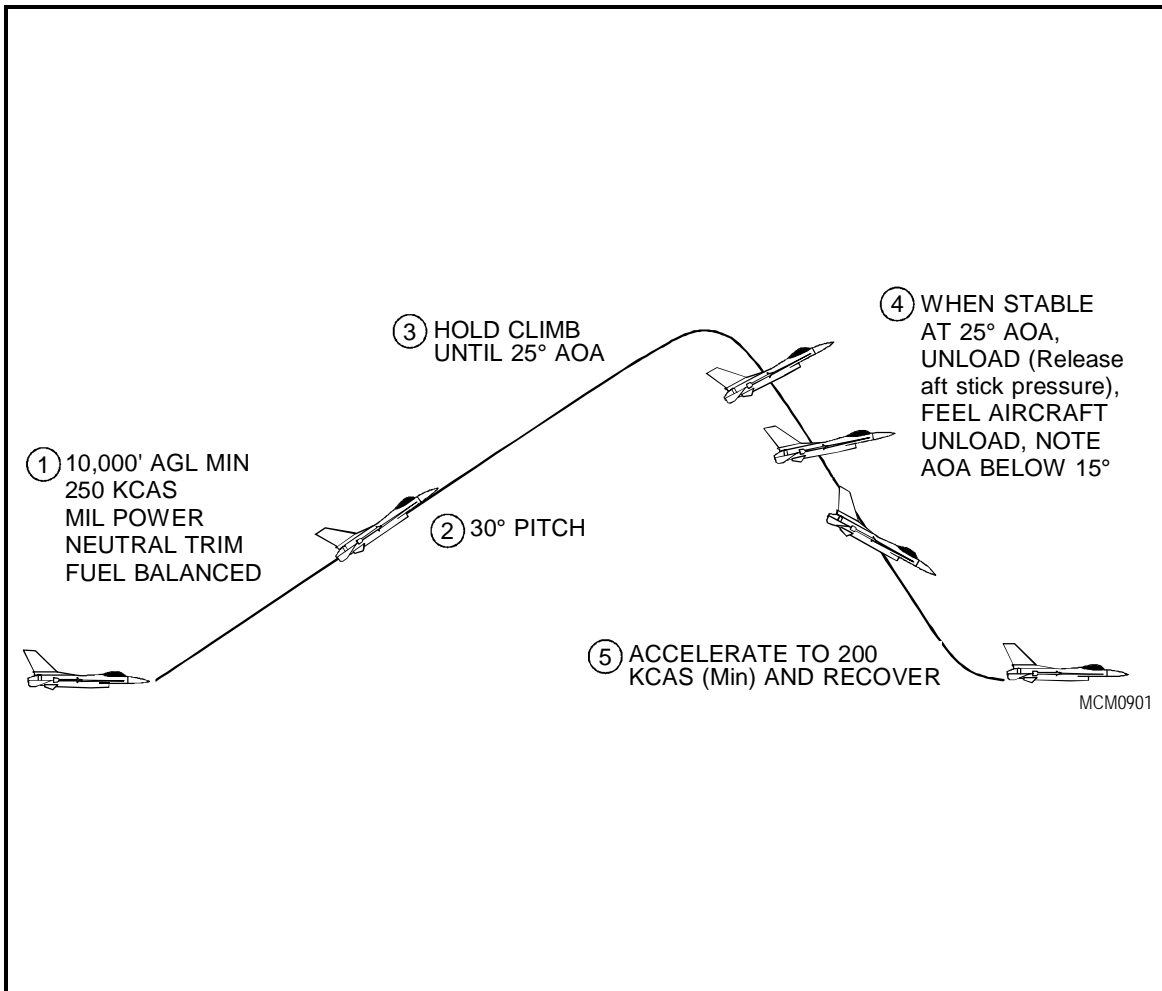
The following exercises and maneuvers are designed to expose you to various parameters within the F-16's flight envelope. When executed correctly, they will explore the aircraft's flight envelope and reinforce your awareness of aircraft performance. Minimum altitudes for the Horn Awareness Series, Confidence Maneuvers, and Advanced Handling Maneuvers is 10,000 feet AGL. Reference the applicable exercises or maneuvers for minimum and recommended entry altitudes.

##### 9.4.1. Horn Awareness And Recovery Training Series (HARTS)

See Figure 9.1 through 9.5 This series of maneuvers is flown to train recovery procedures from high pitch attitude, slow airspeed conditions normally signaled by the horn. It is designed to be flown initially in sequence as a series. These controlled maneuvers will place you into a position in which you may unintentionally find yourself while engaged in air combat maneuvering. This exposure and recovery training will train you to use the proper recovery procedures should you find yourself in this situation during future flying. There are five individual maneuvers in the series described below. The pitch attitude for all these maneuvers should be set and maintained on the ADI **not** the flight path marker, because reference to the HUD flight path results in an increasing attitude as the AOA increases. The key to flying these maneuvers is to use finesse in bringing the nose to the horizon with minimum airspeed loss. If the recoveries are delayed due to slow pilot response or lack of warning horn or if abrupt inputs are made, a departure is possible during these maneuvers. It should be emphasized that the roll to the horizon should be made smoothly avoiding buffet, and smoothly stopped before aft stick is applied. Smooth application of aft stick (if needed) is essential. If the nose is not moving toward the horizon, aft stick should be smoothly applied (up to full command) to get the nose moving and **keep it moving**. If the nose is very high and the airspeed is very slow during recovery, a rapid pitch rate downward may develop. In this case, when the nose approaches vertical downward, a good technique is to apply slight forward stick pressure to slow the pitch rate and protect against overshooting the AOA limiter. See Section VI of the Dash 1.

*NOTE:* HARTS maneuvers are to be flown by CAT I loaded aircraft only.

*WARNING:* For maneuvers 4 and 5, departure susceptibility significantly increases with wing tanks at entry airspeeds between 300 and 325 KCAS or in any configuration with entry bank angles less than 10°.



**Figure 9.1 Unload Maneuver**

**9.4.1.1. Unload Maneuver. HARTS Series #1. (Figure 9.1)**

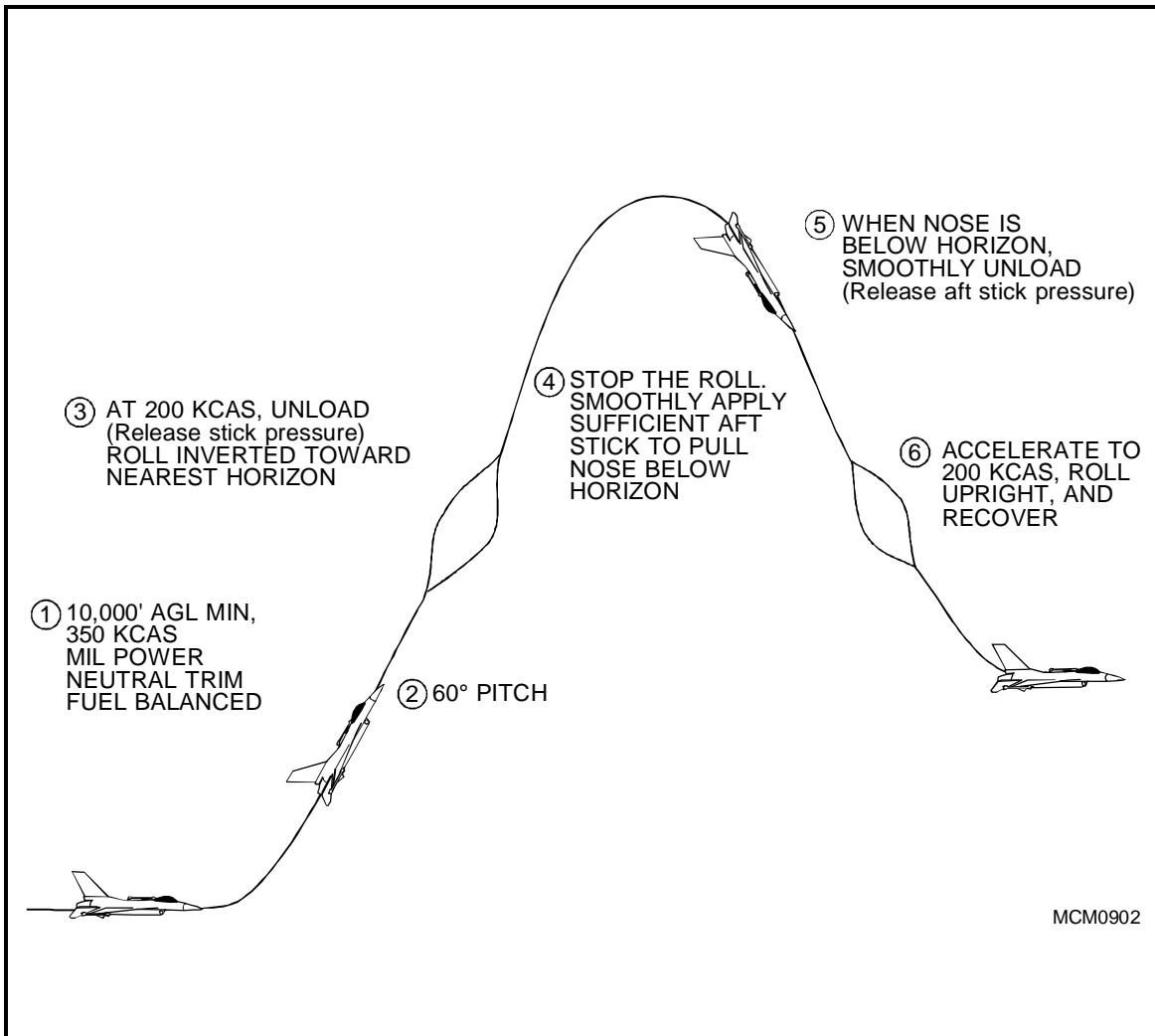
*Objective:* To learn the proper technique required to unload the aircraft and recognize an unloaded condition.

*Setup:* 10,000 AGL or above, 250 KCAS, MIL power, fuel balanced, neutral trim (1 G).

*Description:* Pull up to 30° pitch with approximately 2 - 3 G's. Initially, slight forward pressure is required to maintain pitch attitude. At approximately 150 KCAS, aft stick is required until reaching the limiter. When the aircraft is stable at 25° AOA, unload (release aft stick pressure) and note aircraft unload (check AOA, should be below 15°). Hold the unload until the aircraft accelerates to 200 KCAS minimum. At 200 KCAS, initiate recovery to level flight.

*Comments:* This unload is the key to any safe recovery. This maneuver is to teach you the proper way to unload the F-16 so you can safely roll the aircraft regardless of airspeed. Because the F-16 is flown with neutral trim (set to 1 G), a release of aft stick pressure should bring the AOA to less than 15°. A proper unload at slow airspeed and high AOA is to release the aft stick pressure. This unload may take 2 - 3 seconds and will make you feel light in the seat. On the first practice maneuver, look at the AOA tape, note the AOA and the unload feel. This maneuver should be practiced until the recovery can be accomplished without looking inside the cockpit.





**Figure 9.2 Nose High Recovery Maneuver**

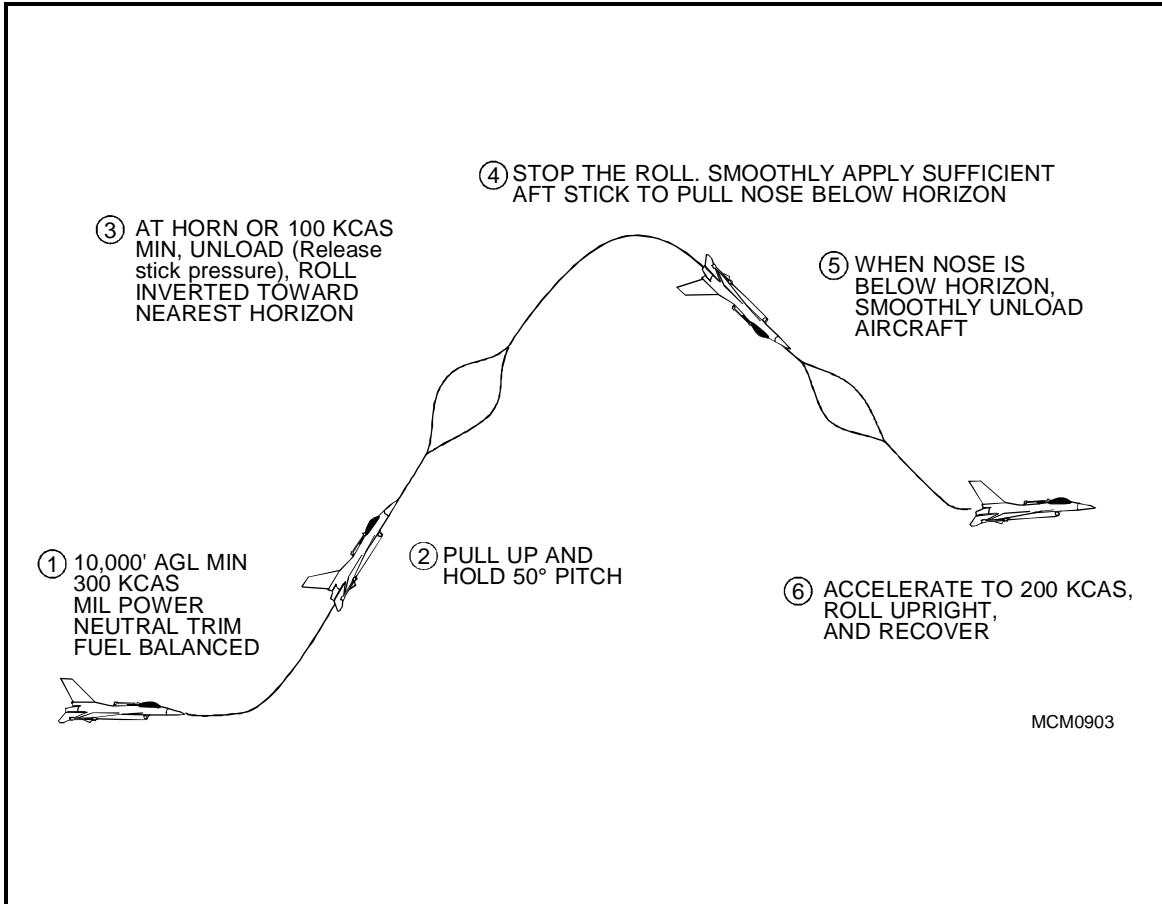
**9.4.1.2. Nose High Recovery Maneuver. HARTS Series #2. (Figure 9.2)**

*Objective:* To systematically practice the unload maneuver and rolling to the nearest horizon while unloaded.

*Setup:* 10,000' AGL minimum, 350 KCAS, MIL power, fuel balanced, neutral trim.

*Description:* Pull up to 60° pitch with approximately 2 - 3 G's and hold. Slight forward stick pressure is required to hold the pitch attitude. At 200 KCAS, unload (release stick pressure) and roll the aircraft inverted to the nearest horizon using positive but smooth control inputs. Stop the roll with aileron. When wings level inverted, smoothly apply sufficient aft stick to pull the nose below the horizon. Once the nose is below the horizon, **unload** and accelerate to 200 KCAS. At 200 KCAS, roll upright and recover.

*NOTE:* IAW Dash 1 procedures, if altitude is a factor during the recovery, allow airspeed to increase to a **minimum** of 150 knots, unload the aircraft to less than 1 G, smoothly roll upright and recover to level flight.



**Figure 9.3 Horn Demonstration Maneuver**

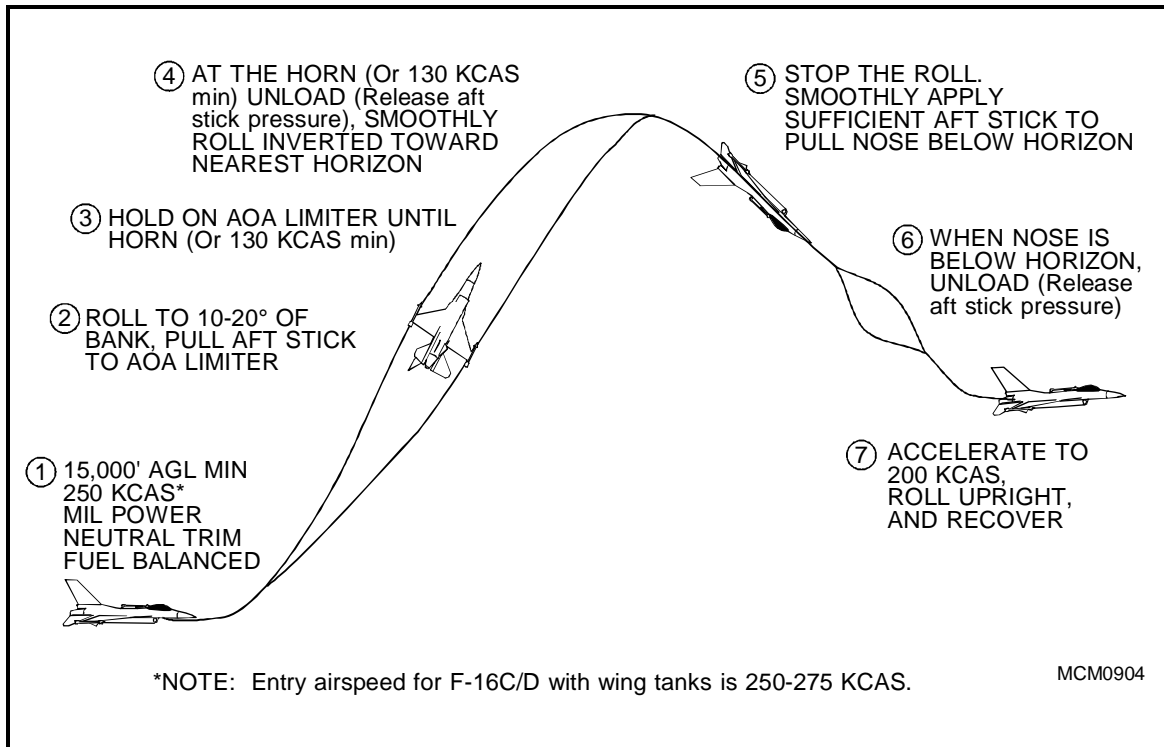
9.4.1.3. **Horn Demonstration Maneuver. HARTS series #3. (Figure 9.3)**

*Objective:* To demonstrate and check the operation of the low airspeed/nose high position warning horn and to practice proper recovery procedures at the horn.

*Setup:* 10,000' AGL or above, 300 KCAS, MIL power, fuel balanced, neutral trim.

*Description:* Pull up to 50° of pitch with approximately 2 - 3 G's and hold. Allow airspeed to decay until warning horn sounds or 100 KCAS, whichever occurs first. At the horn (or 100 KCAS minimum), unload (release stick pressure); then smoothly roll inverted to the nearest horizon. Stop the roll, then smoothly apply sufficient aft stick to track the nose below the horizon. With the nose below the horizon, unload and accelerate to 200 KCAS. At 200 KCAS, roll upright and recover.

*Comments:* The horn should come on between 120 KCAS and 130 KCAS. A secondary objective of this maneuver is to verify that the horn works prior to flying the horn recovery maneuvers. This should be the first time you hear the horn during this series of maneuvers. If the horn does not come on prior to 100 KCAS, discontinue this series of horn recovery maneuvers and write up the horn after the flight. Smooth but positive control inputs and attention to unload cues are imperative. The aircraft rolls smoothly while unloaded; however, the roll must be positively stopped when inverted prior to smoothly applying aft stick to avoid assaulting both flight control limiters simultaneously.



**Figure 9.4 Horn Recovery Maneuver, 50° - 70°**

9.4.1.4. **Horn Recovery Maneuver, 50° - 70°. HARTS Series #4. (Figure 9.4.)**

*Objective:* Practice recovery at the horn from nose high, high AOA, low airspeed conditions.

*Setup:* 15,000' AGL or above, 250 KCAS, MIL power, fuel balanced, neutral trim.

*NOTE:* If flown in an F-16C/D, configured with wing tanks, entry airspeed will be 250 to 275 KCAS.

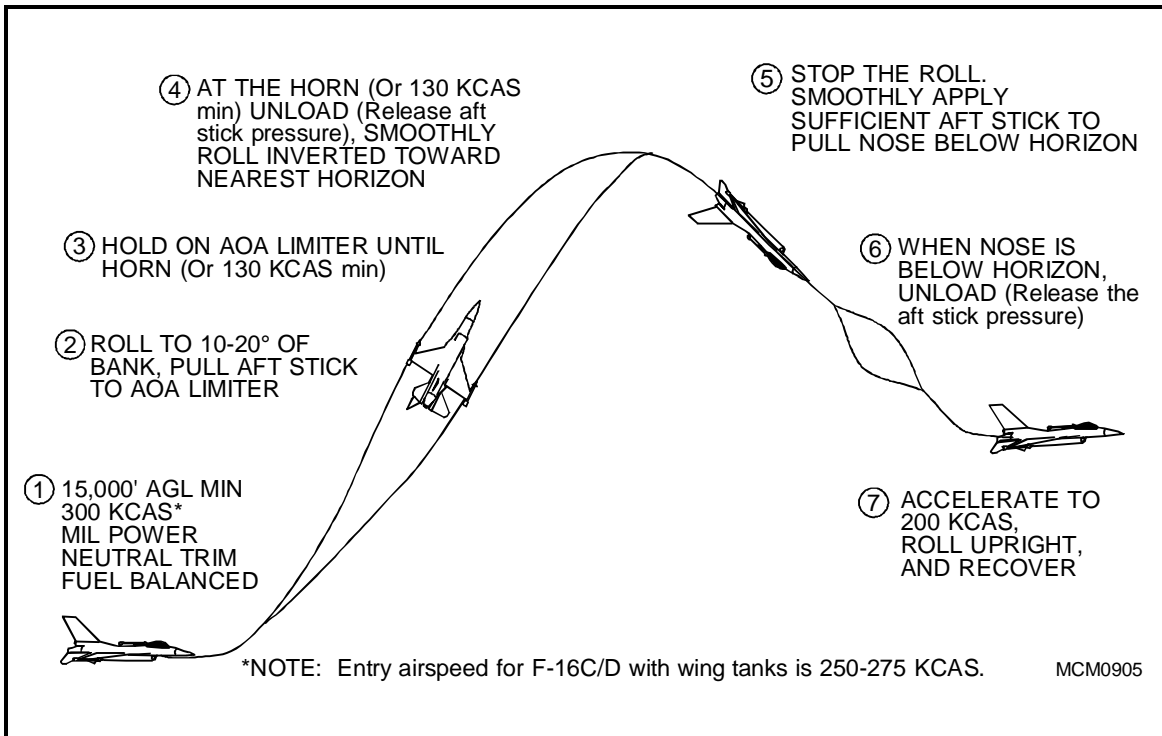
*Description:* Roll into 10° - 20° bank and apply full aft stick (limiter). When the horn sounds (or 130 KCAS, whichever occurs first), unload (release aft stick pressure); then roll the aircraft inverted toward the nearest horizon. Stop the roll, then smoothly apply sufficient aft stick to track the nose below the horizon. With the nose below the horizon, unload and accelerate to 200 KCAS. At 200 KCAS, roll upright and recover.

*Comments:* The 250 KCAS entry airspeed will cause the horn airspeed to occur prior to extremely high pitch attitudes if back stick is applied fairly quickly to the AOA limiter. Pitch attitudes of 50° - 70° are typical, with the horn activating at 150 KCAS to 170 KCAS. The low initial bank angle is necessary because bank angle tends to increase as the pull-up progresses. If the pull-up is started with more than 30° bank, the horn may not come on because overbanking causes insufficient pitch attitude to reach the horn envelope (45° nose high). Full aft stick is used to ensure the aircraft is on the limiter at the horn. This will prevent an inadvertent pitch pulse at low airspeed which could cause an AOA overshoot.

*C Model Specifics:* Based on flight test experience, departure resistance and desired learning objectives should not be adversely affected with any of the following store combinations:

- One AIM-9 missile at station 1 or 9.
- Two AIM-9 missiles, stations 1 and 9.
- A centerline pylon at station 5.
- A centerline fuel tank.

**WARNING:** Departure susceptibility increases significantly if airspeed and bank angle parameters are not met.



**Figure 9.5 Horn Recovery Maneuver, 70° - 110°**

**9.4.1.5. Horn Recovery Maneuver, 70° - 110°. HARTS Series #5. (Figure 9.5)**

*Objective:* Practice recovery at the horn from very nose high, high AOA, low airspeed conditions.

*Setup:* 15,000' AGL or above, 300 KCAS, MIL power, fuel balanced, neutral trim.

*NOTE:* If flown in an F-16C/D, configured with wing tanks, entry airspeed will be 250 - 275 KCAS. This may result in a lower pitch attitude than desired but is necessary due to departure tendencies when entered at higher airspeeds.

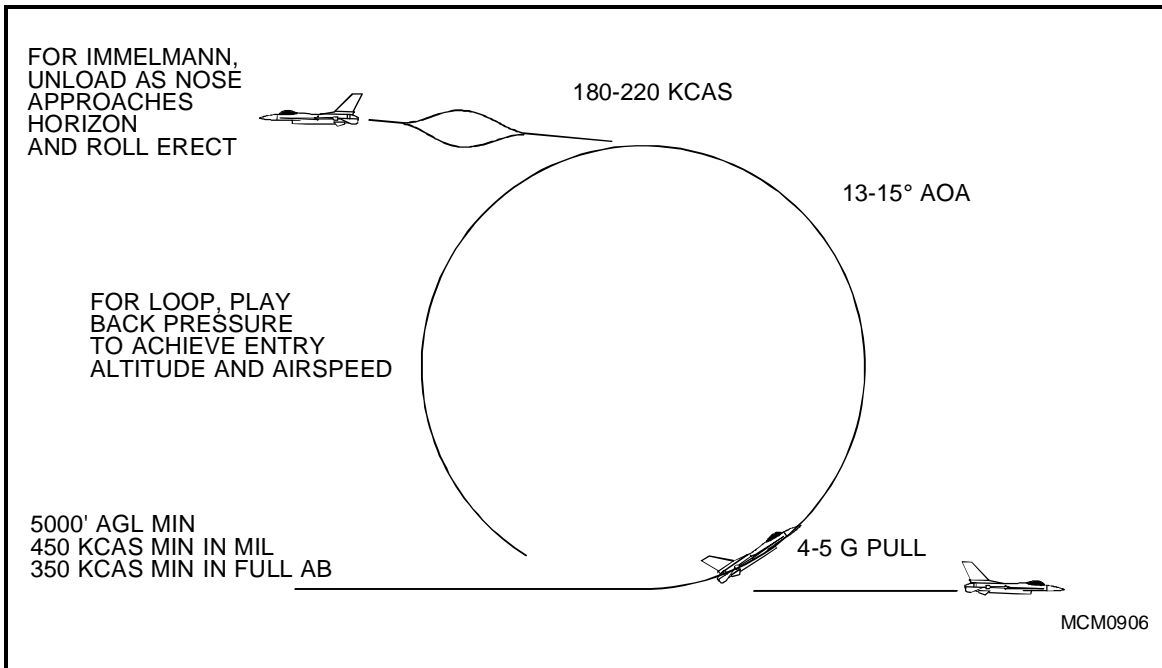
*Description:* Roll into 10° - 20° of bank and apply full aft stick (limiter). When the horn sounds (or at 130 KCAS, whichever occurs first), smoothly unload (release aft stick pressure); then roll the aircraft inverted toward the nearest horizon. Stop the roll, then smoothly apply sufficient aft stick to track the nose below the horizon. With the nose below the horizon, unload and accelerate to 200 KCAS. At 200 KCAS, roll upright and recover.

*Comments:* This maneuver is identical to the previous one except for higher entry airspeed. The entry airspeed will allow the nose to rise to 70° - 110° pitch before horn activation. The horn should come on in the 180 KCAS to 200 KCAS range. Unload the aircraft before any amount of roll input is made, then smoothly initiate sufficient aft stick to get the nose moving below the horizon. The rest of the recovery technique is exactly the same as for the previous maneuver.

*C Model Specifics:* Based on flight test experience, departure resistance and desired learning objectives should not be adversely affected with any of the following store combinations:

- One AIM-9 missile at station 1 or 9.
- Two AIM-9 missiles, stations 1 and 9.
- A centerline pylon at station 5.
- A centerline fuel tank.

**WARNING:** Departure susceptibility increases significantly if airspeed and bank angle parameters are not met.



**Figure 9.6 Loop/Immelmann**

#### 9.4.2. Aerobatics

##### 9.4.2.1. Loop

At 450 KCAS minimum, above 5000' AGL (10,000' AGL recommended), with MIL power, begin a wings level, 4 - 5 G pull (Figure 9.6). As airspeed dissipates across the top, maintain smooth pitch rate. The AOA should be 13° - 15° (at 14° AOA you should feel light buffeting). As the nose comes back through the horizon inverted (approximately 180 - 220 KCAS) and airspeed begins to build, ease off the back pressure and play the G to arrive back in level flight near entry altitude and airspeed. In a tanked F-16B/D, expect to lose 1000' or 50 knots attempting to achieve entry airspeed or altitude, respectively. If AB is used, enter at 350 KCAS minimum. Use sufficient G on the back side of the maneuver to preclude excessive airspeed buildup.

##### 9.4.2.2. Immelmann

At 450 KCAS minimum, above 5000' AGL (10,000' AGL recommended), with MIL power, begin a wings level, 4 - 5 G pull (Figure 9.6). As airspeed dissipates across the top, maintain a smooth pitch rate. The AOA should be 13° - 15° (at 14° AOA you should feel light buffeting). As the nose approaches the horizon inverted, unload and roll the aircraft to arrive upright wings level in level flight (FPM on the horizon line). If AB is used, enter at 350 KCAS minimum. Roll out at the top remains the same.

##### 9.4.2.3. Split S

Enter at or above 15,000' AGL, between 300 - 350 KCAS, MIL power, level to 10° nose high (Figure 9.7). Roll unloaded to wings level inverted and smoothly apply full aft stick. Terminate the maneuver in straight and level flight above 5000' AGL. Note change in altitude and airspeed.

##### 9.4.2.4. Cloverleaf

Pick a point 90° off the nose in the direction of turn. At 450 KCAS minimum, above 5000' AGL, (10,000' AGL recommended), MIL power, begin a wings level 3 - 4 G pull (Figure 9.8). At approximately 45° nose high, decrease back pressure and start a rolling pull in the direction of the 90° point. The rate of roll should be planned to reach a wings level inverted position with the nose on the horizon at the 90° point (airspeed approximately 200 - 220 KCAS). Continue the maneuver as in the backside of a loop, playing the G's to arrive near the entry airspeed and altitude.

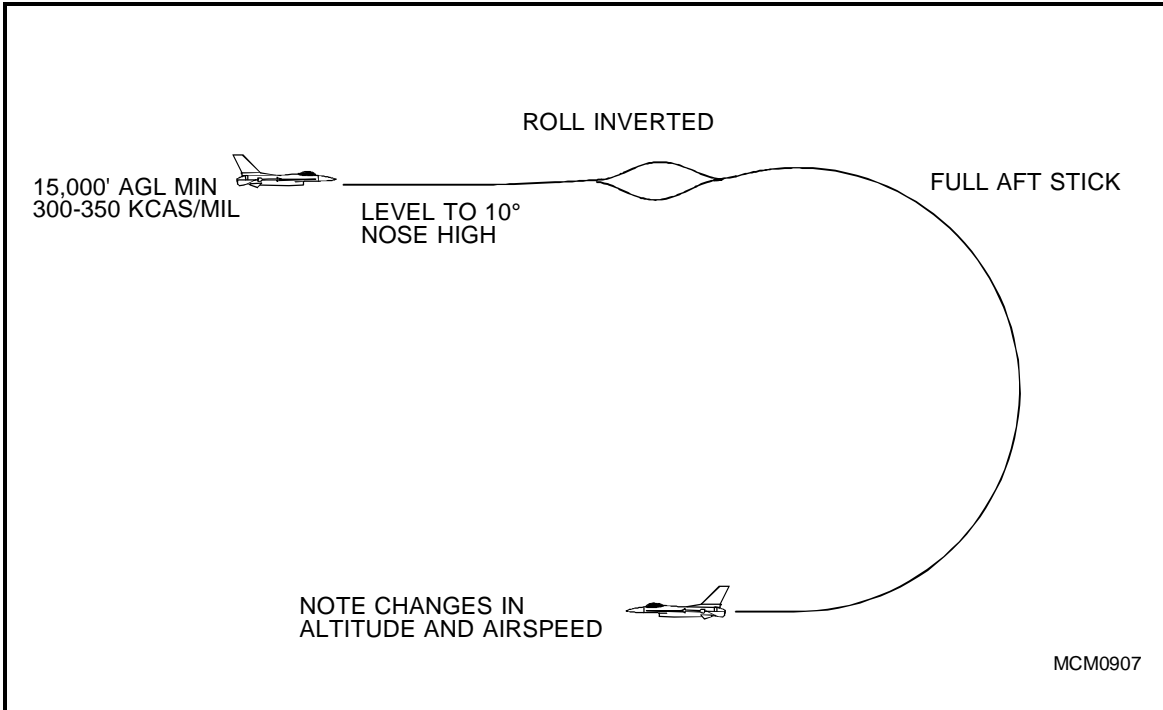


Figure 9.7 Split S

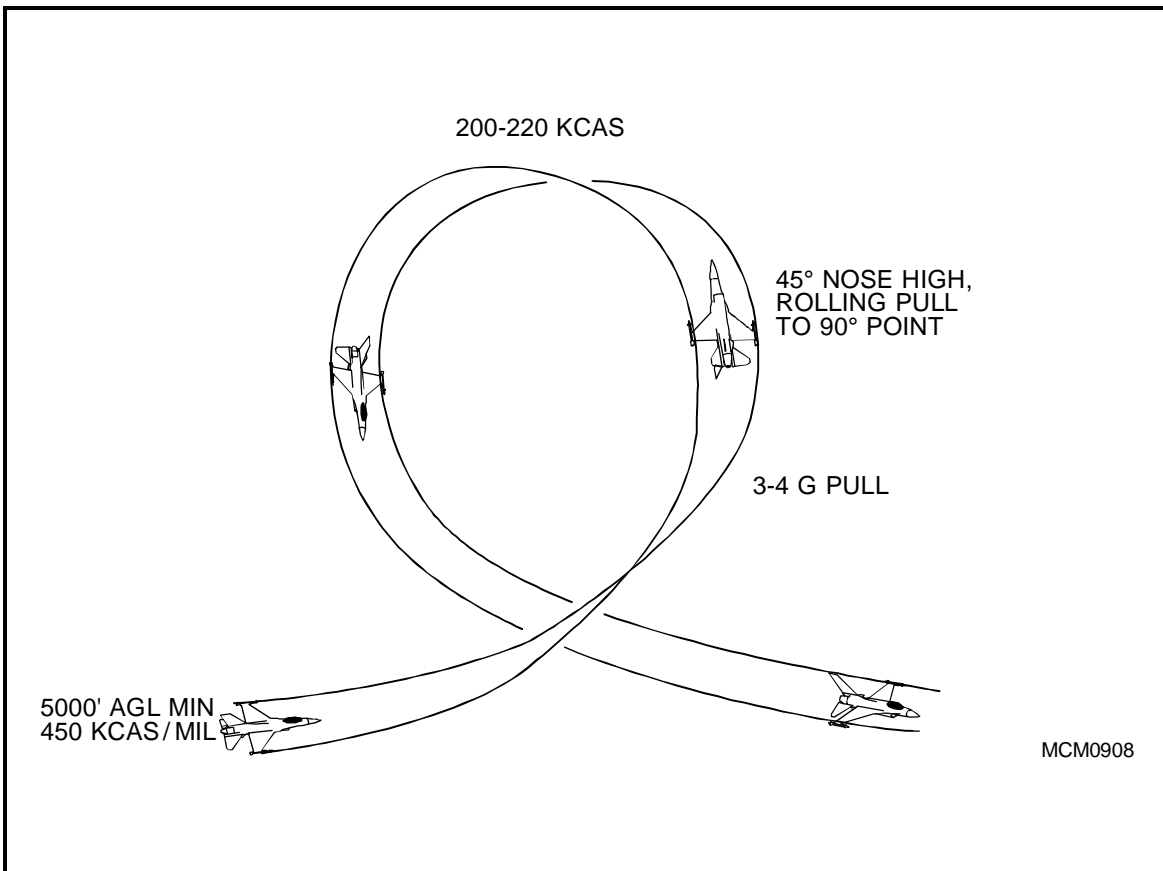


Figure 9.8 Cloverleaf

9.4.3. Advanced Handling Maneuvers

9.4.3.1. Pitchback

This maneuver is a hard, then optimum turn (approximately 13° AOA) beginning with the lift vector above the horizon and ending with it below (Figure 9.9). Enter above 5,000' AGL at 400 KCAS or higher. Select full AB, roll into 40° - 50° of bank and simultaneously begin a 5 - 7 G climbing turn. After 90° of turn, bank should be approximately 90°. After 180° of turn, it should be 135°. At this point, the maneuver ends. You should have gained 3000 to 5000' and have a minimum airspeed of 300 KCAS. You may have to reduce G during the maneuver to preserve airspeed.

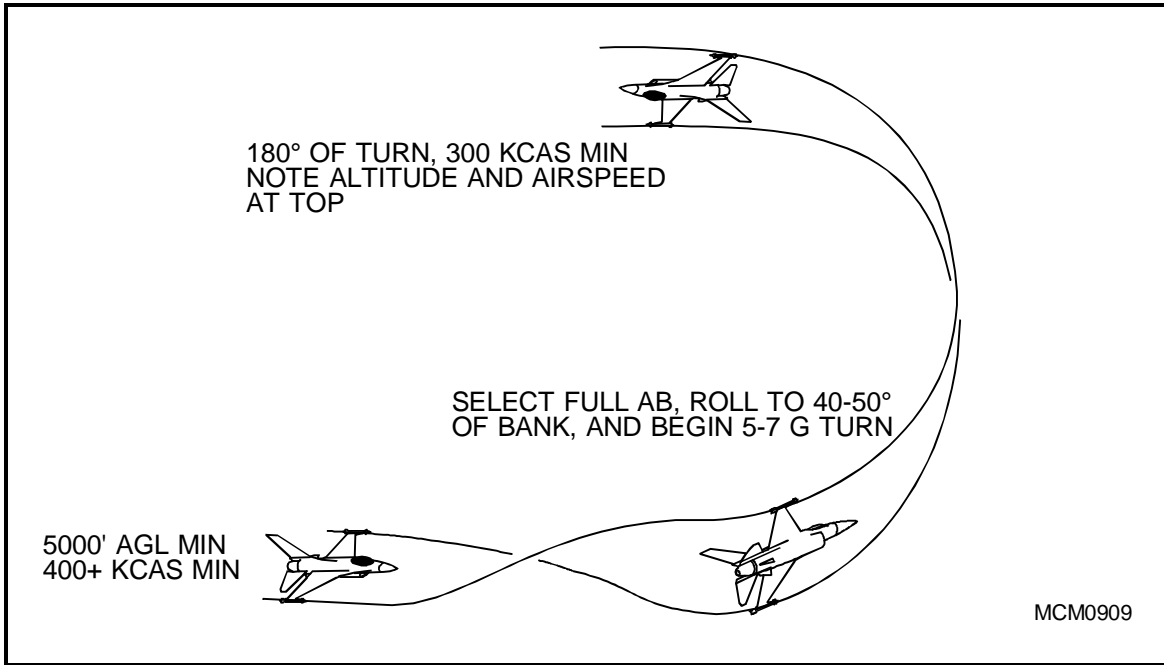


Figure 9.9 Pitchback

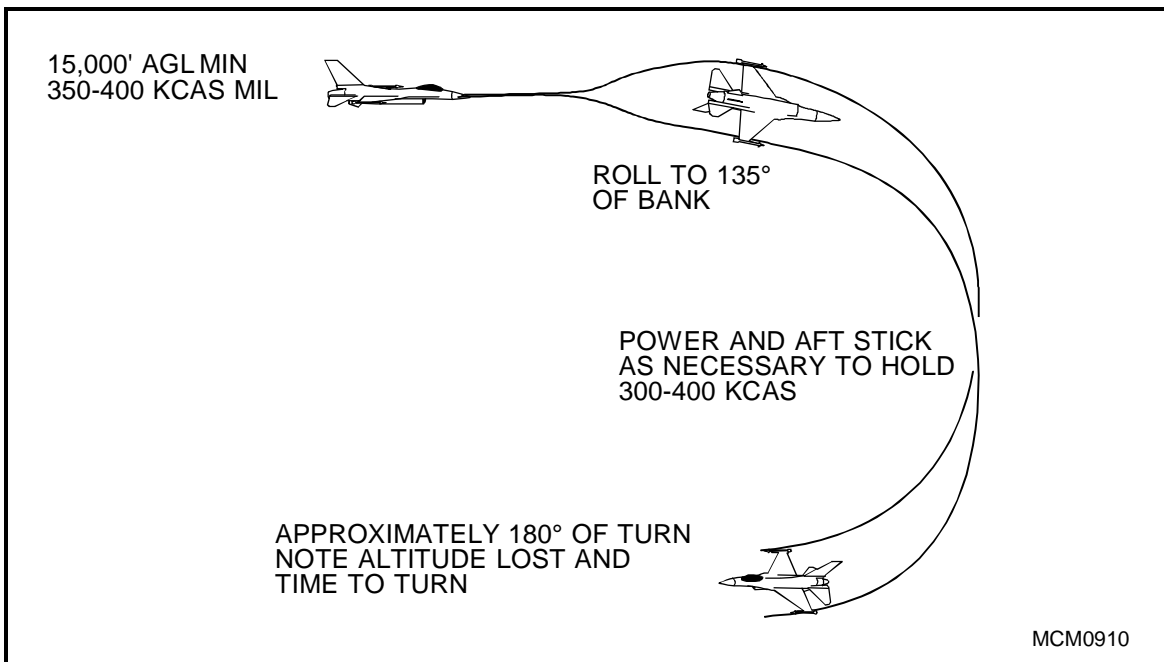


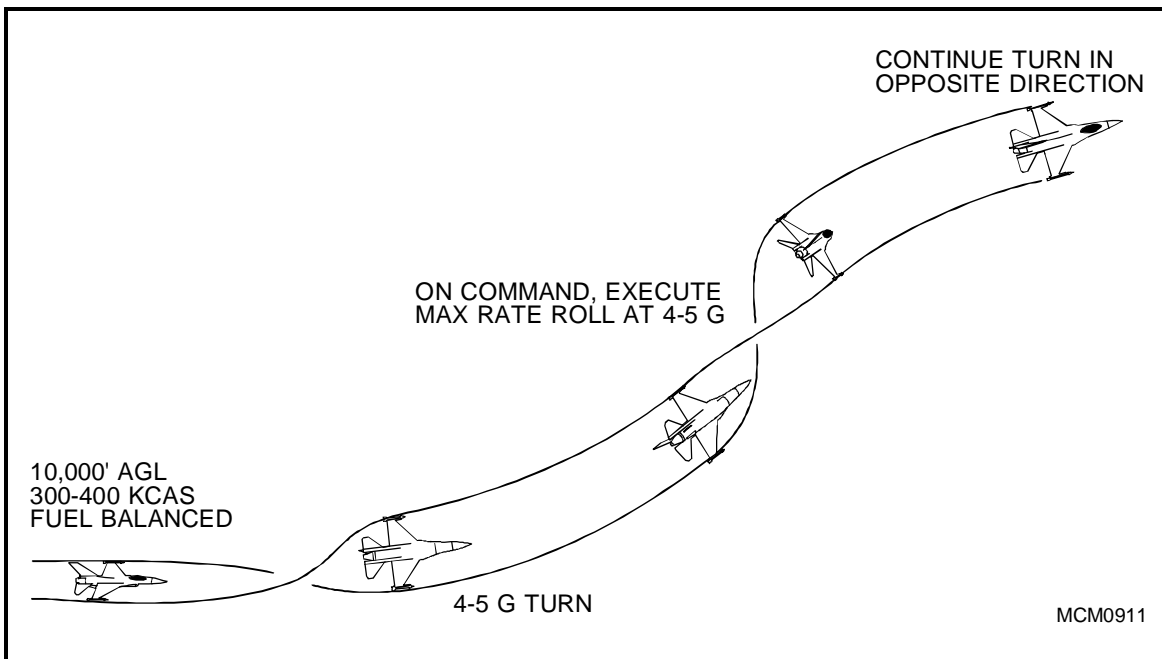
Figure 9.10 Sliceback

#### 9.4.3.2. Sliceback

Enter at or above 15,000' AGL, between 350 - 400 KCAS, MIL power. Initially roll into 135° of bank and smoothly increase aft stick as required to maintain 300 - 400 KCAS (Figure 9.10). The maneuver is completed upon roll out in level flight after approximately 180° of turn. The sliceback is a split-S type maneuver designed to make a 180° descending turn while minimizing turn time and optimizing energy state. If speed is above 400 KCAS and a descending turn is required, reduced power and speed brakes may be necessary if minimum turn radius and altitude loss are desired.

#### 9.4.3.3. Reversals/Rolling Maneuvers Demonstration

Enter above 10,000' AGL at 300 - 400 KCAS with fuel balanced. Establish a 4 - 5 G turn in MIL power (Figure 9.11). When the instructor calls "Reverse," reverse the direction of turn while maintaining G loading. This maneuver demonstrates the characteristics of a vector roll and its effects on energy state. It's used in air-to-air training by attackers to prevent a flight path overshoot and by defenders, as a last ditch maneuver, to force one. Full lateral stick pressure produces maximum roll rate at any AOA and airspeed, while limiters decrease roll rate below 250 KCAS or above 15° AOA. Rudder is not required at any AOA/airspeed.

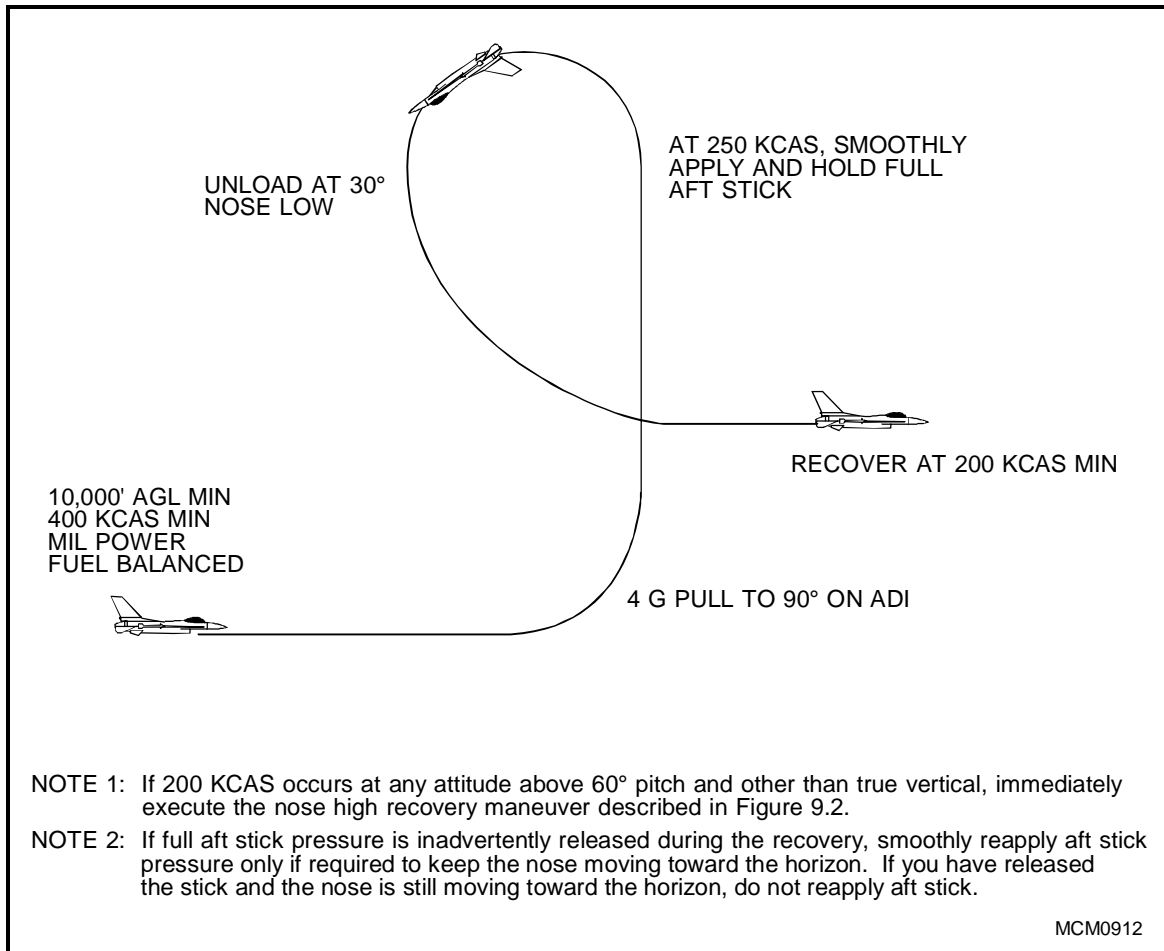


**Figure 9.11 Reversals/Rolling Maneuvers**

#### 9.4.3.4. Vertical Recovery Demonstration

The objective is to demonstrate the effect of the 30° seat when extremely nose high, G and pitch rate available at low airspeed and high AOA when on the pitch limiter, and ability to pull down through the vertical without fear of getting the nose buried (Figure 9.12). Set up at 10,000' AGL minimum, 400 KCAS minimum, MIL power, and fuel balanced. Make a wings-level pull up at approximately 4 G's and establish a vertical attitude on the ADI (see note 1). Note how the 30° seat angle creates an impression of being more than pure vertical. At 250 KCAS, smoothly apply and hold full aft stick pressure to establish a pitch rate towards the horizon (see note 2). Continue to hold full aft pressure while the aircraft passes nose down vertical. When the nose is 30° below the horizon, unload and accelerate to 200 KCAS minimum before completing recovery to wings level flight. During this demonstration, the airspeed will decrease, and with full aft stick, the G will drop to 1.6 - 1.7; but the limiter, controlling AOA, will still permit a rapid pull through approximately 240° of pitch change.





**Figure 9.12 Vertical Recovery**

#### 9.4.4. Departure Indicators

The previously discussed maneuvers are a series of events designed to develop a "feel" for the F-16's handling characteristics. Additionally, the HARTS teaches the proper procedures to recover from a nose high, low airspeed situation and avoid departure from controlled flight. While these are planned events, situations may occur which place you in similar circumstances with less recovery/reaction time than optimum. Several, but not all inclusive, departure indicators are:

- A sensation of lateral side forces developing.
- Uncommanded A/C movements (pitch and/or roll).
- AOA pegged at +32° if upright or -5° if inverted.
- Airspeed oscillating below 200 KCAS.

#### 9.4.5. Dive Recovery Maneuver

Dive recovery capability is a function of pullout load factor, dive angle, true airspeed, and FLCS limiting. In a nose low, low airspeed (below approximately 350 KCAS) situation, rolling wings level, pulling to the limiter, retracting speed brakes, and selecting/maintaining MIL or AB thrust minimizes altitude lost. If airspeed is above 350 KCAS, rolling wings level, pulling to the limiter, opening the speed brakes, and selecting/maintaining IDLE thrust reduces altitude lost. During a supersonic dive recovery at or above 1.4 Mach, the engine will remain at or near MIL thrust with the throttle at IDLE. As airspeed decreases below 1.4 Mach, thrust decreases, but will not decrease to idle thrust until airspeed is below 0.9 Mach (GE engine) or 0.84 Mach (PW engine). Altitude required for recovery in this situation may be significantly greater than anticipated. Loss of consciousness in this situation could be fatal. During a

recovery, constantly assess altitude remaining versus altitude required. If you are disoriented or unable to determine attitude from the HUD, reference the round dials. If altitude is critical, the FLCS may not allow sufficient G/AOA for recovery. Unnecessarily delaying the ejection decision could preclude safe ejection prior to ground impact.

To practice dive recoveries, attain an entry altitude of 15,000' AGL minimum, an airspeed of 350 KCAS (high speed recovery) or 250 KCAS (low speed recovery), power as required, and establish a 60° dive with less than 30° of bank. Prior to 10,000' AGL and 550 KCAS (high speed recovery) or 350 KCAS (low speed recovery), recover by rolling wings level, set throttle and speed brakes as appropriate, and apply maximum G until the aircraft is in level flight or climbing. Refer to T.O. 1F-16-1-1 dive recovery charts for additional data. While practicing this maneuver, do not "snatch" the G's to the maximum G onset rate since this increases the potential for a GLOC incident.

## **9.5. Fighter Proficiency Exercises**

Maneuvering during proficiency exercises entails a basic objective in addition to "rolling out at six." During each of the following exercises, weapons switchology ("playing the piccolo") should be practiced.

### **9.5.1. Gun Exercises**

The following gun exercises are designed to practice pipper placement, pipper control, symbology awareness, and maneuvering in respect to another aircraft. While accomplishing these exercises, do not fail to continually cross-check your range and overtake. Do not get padlocked on the green stuff and forget what's happening spatially around you. Think situation awareness. Know your airspeed, altitude, and fuel.

#### **9.5.1.1. Offensive Ranging Exercise**

Start 3000' - 7000' in trail and close comfortably to 500', noting size comparisons at different ranges (lock and no lock) and angles off.

#### **9.5.1.2. Basic Tracking Exercise**

The defender sets speed at 300 - 350 KCAS. The attacker sets up co-speed in a position 2000' - 2500' at six o'clock at the same altitude (Figure 9.13). At the call "Begin maneuver," the defender goes into 3 - 4 G turns, approximately 45° - 60° either side of course. The attacker attempts to maintain between 1000' - 2000' back in a tracking position. The attacker will reposition on reversals as necessary so as to stay out of jet wash, or if inside or outside of weapons parameters. The defender will use the vertical and vary power settings as proficiency dictates. The attacker should practice with various gunsight modes and lock-on/no lock-on as proficiency permits.

Throughout the maneuver, the attacker should attempt to maintain good aircraft position and pipper placement while controlling range and overtake with small out-of-plane maneuvers and power. The attacker gains practice in recognizing the need for a reposition (using the vertical) when either inside or outside of gun tracking parameters.

#### **9.5.1.3. Cine Track Exercise**

The defender sets speed at 400 KCAS, altitude approximately 20,000' (Figure 9.14). The attacker establishes approximately 50 knots of overtake from a perch position (five - seven o'clock) about 3500' - 4000' aft. While closing, the attacker should call any AIM-9 shots on the radio. At approximately 2000', the attacker calls "Begin maneuver." The defender should add power but allow the attacker a slight thrust advantage (non-AB), and, with a constant tally, enter a 4 G turn. After turning approximately 120°, the defender will reduce bank to 30° - 45° and begin a climb. The maneuver continues until the defender reaches 250 - 300 KCAS, at which time he should do a sliceback while accelerating to 350 - 400 KCAS. Maneuvering by the defender should not be at max performance nor at such a low G that tracking is difficult. The maneuver may continue to a barrel roll (approximately 30° nose high and 3 G's) followed by a horizontal turn. The maneuver may be terminated at any time during the profile.

This exercise will allow the attacker to practice short range AIM-9 employment on a non-maneuvering target and continuous gun employment under varying flight conditions (level, climbing, descending,

accelerating, decelerating and/or rolling). The defender must maintain a tally and remain predictable through the exercise.

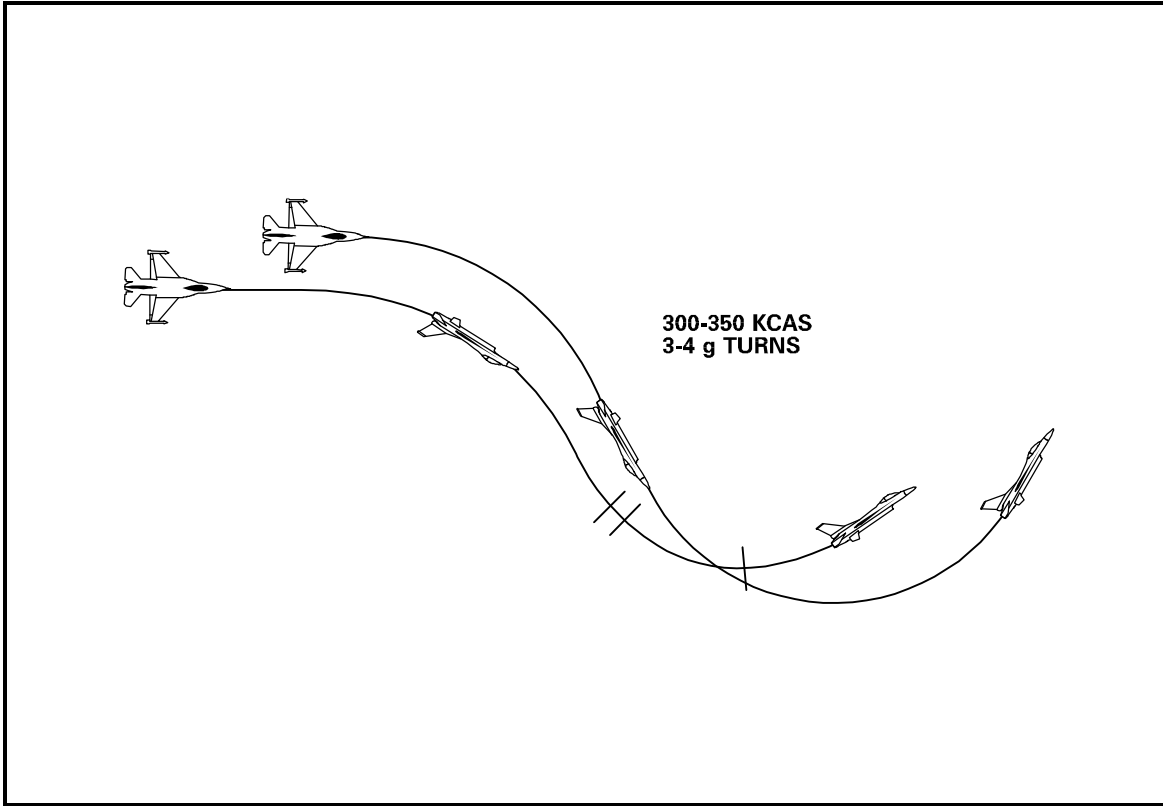
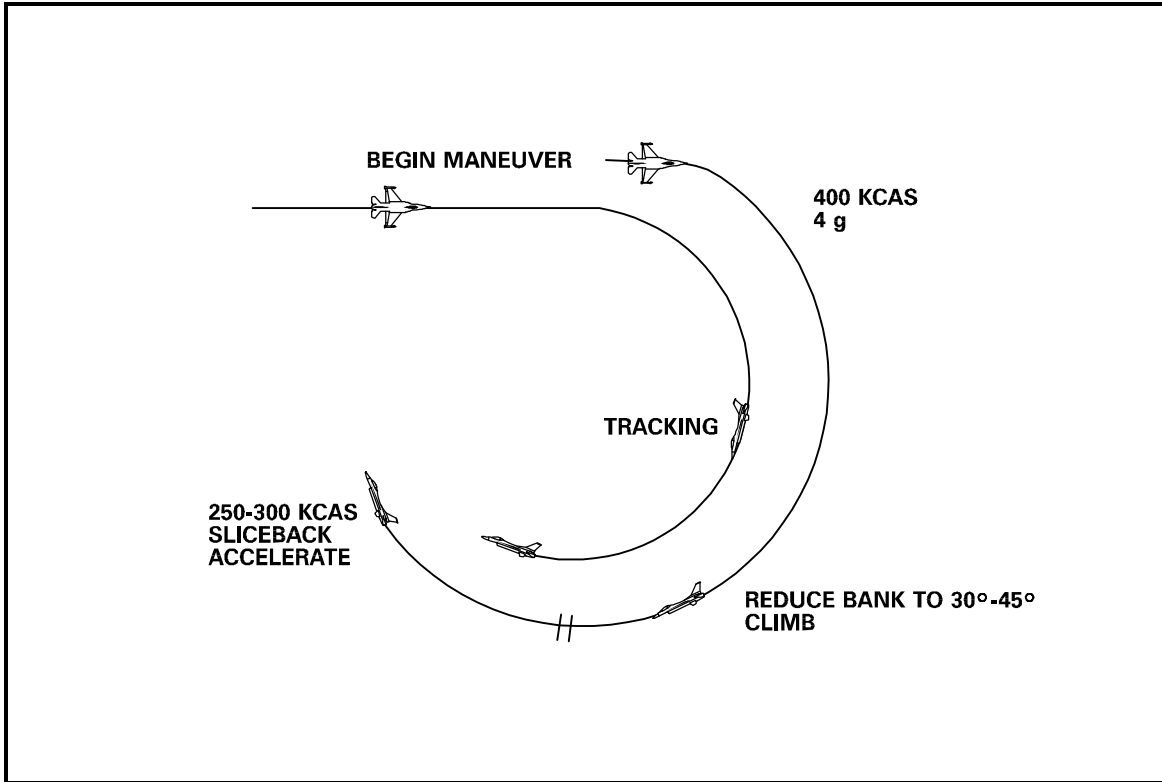


Figure 9.13 Basic Tracking Exercise



**Figure 9.14 Cine Track Exercise**

#### 9.5.1.4. Roll-Slide Attacks

Defender sets speed at 300 to 400 KCAS (Figure 9.15). The attacker initially positions approximately line abreast, at least 3000' out, with an airspeed and altitude advantage. At "begin maneuver," the defender flies a non-maneuvering flight path. The attacker performs a roll-slide gun attack by initially pulling his nose into lead pursuit, and then adjusting G and roll rate so as to set up a controlled rate of movement of the pipper towards and finally through the defender. The trigger should be squeezed at the appropriate time and out-of-plane maneuvers may be performed. Multiple passes may also be performed.

This maneuver teaches the attacker to establish required lead and to plan roll rate and G to achieve snapshot parameters on a non-maneuvering target from a beam or front hemisphere start. The skill is of primary importance when attacking tail-armed opponents or during gun attacks at very high angle-off. One of the primary skills to be emphasized is to effectively employ the gun without violating training rules/minimum range.

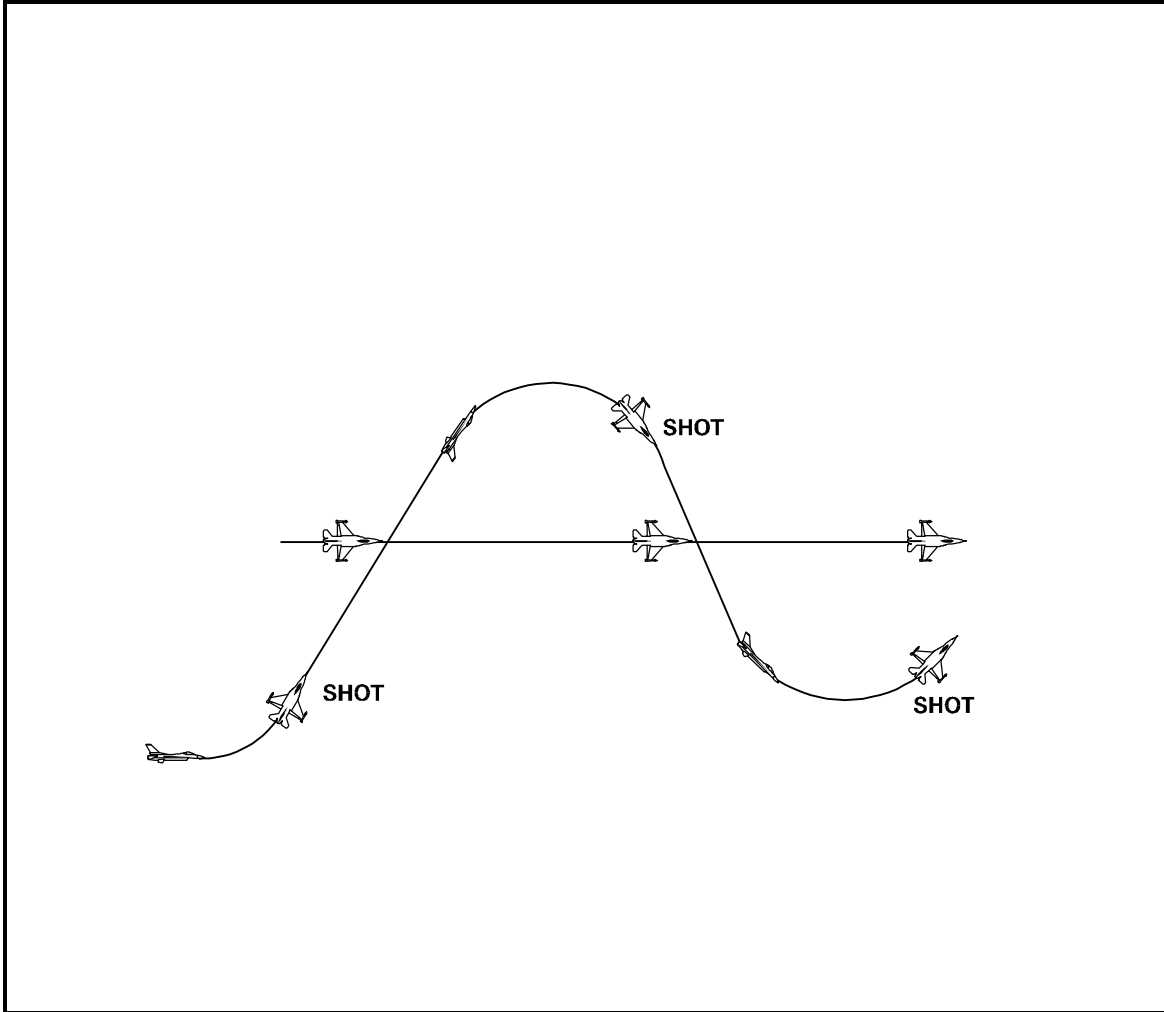
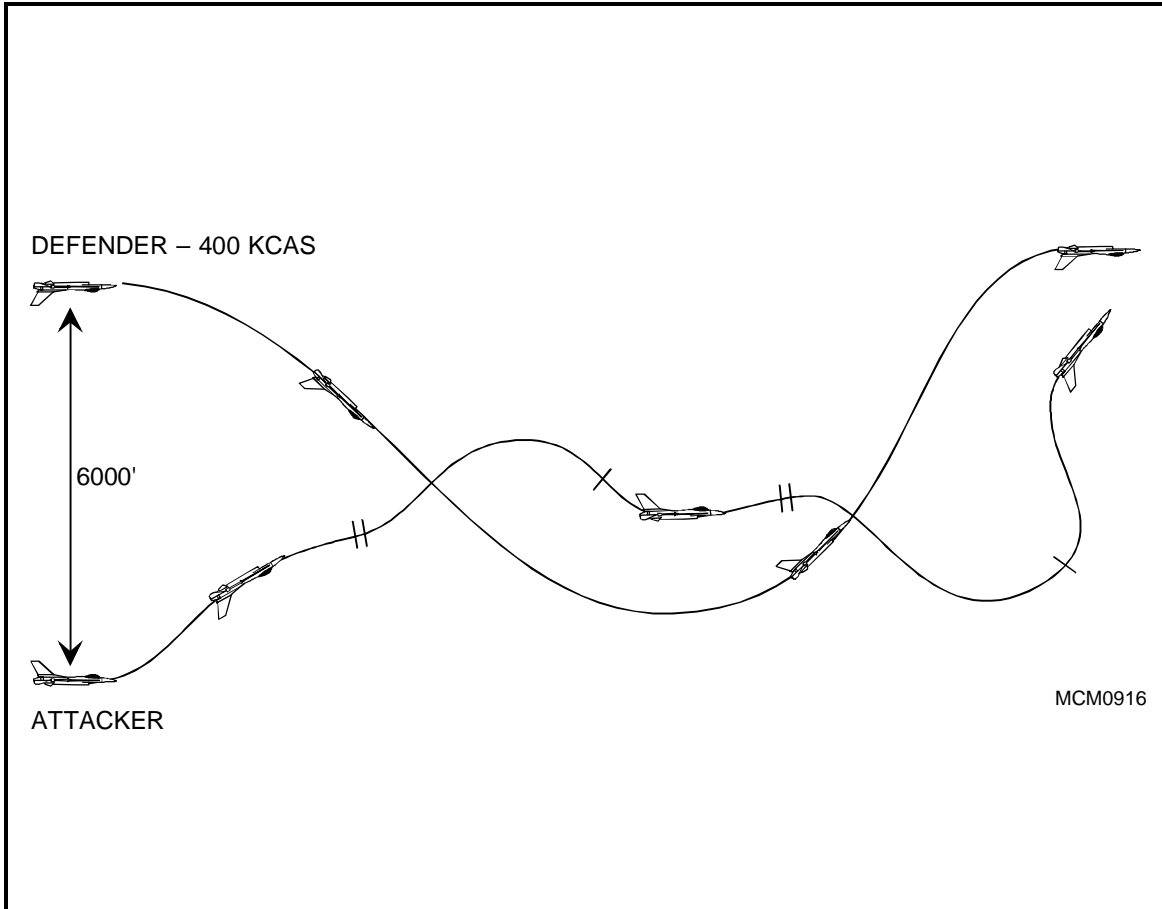


Figure 9.15 Roll-Slide Attacks



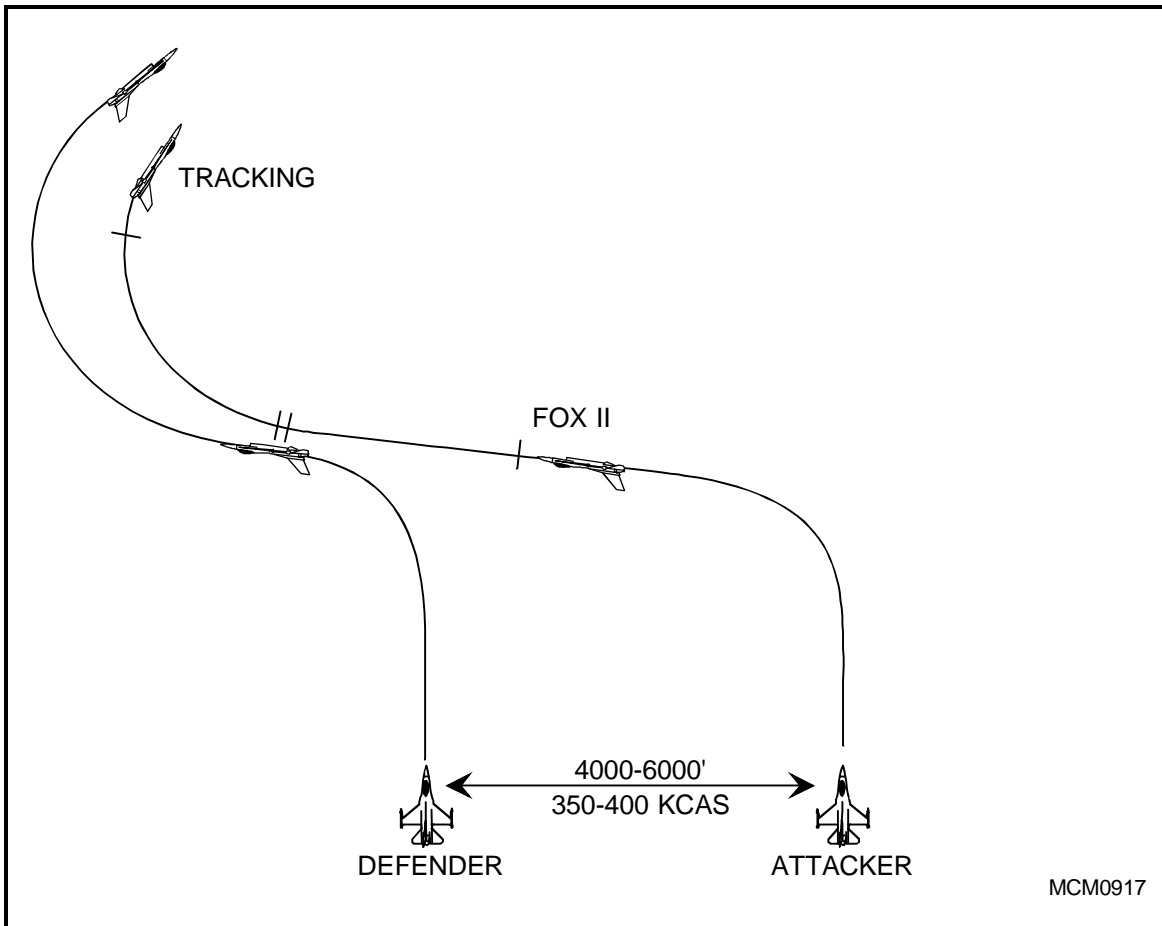
**Figure 9.16 Snapshot Exercise**

#### 9.5.1.5. Snapshot Exercise

Attacker starts 6000' line abreast with defender and airspeed approximately 400 KCAS (Figure 9.16). At the "Begin maneuver" call, the defender starts a level turn into the attacker using G as necessary to create moderate ( $90^\circ - 110^\circ$ ) angle-off. The attacker establishes lead and maneuvers for a snapshot, after which he repositions for another shot. Excessive G by the defender may result in HCAs greater than  $135^\circ$  in which case the maneuver will be discontinued.

This maneuver forces the attacker to assess aspect angle, angle-off, and LOS rate, and to predict target motion; it allows practice of the switchology required for snaphooting in a controlled environment.

**CAUTION:** Min-range bubble integrity must be maintained; if line-of-sight stops, you are on a collision course and should immediately correct and/or knock-it-off. Sight must be maintained at all times during maneuvering to ensure safe practice.



**Figure 9.17 Heat to Guns (Belly/Guns)**

#### 9.5.1.6. Heat to Guns Exercise (Belly/Guns)

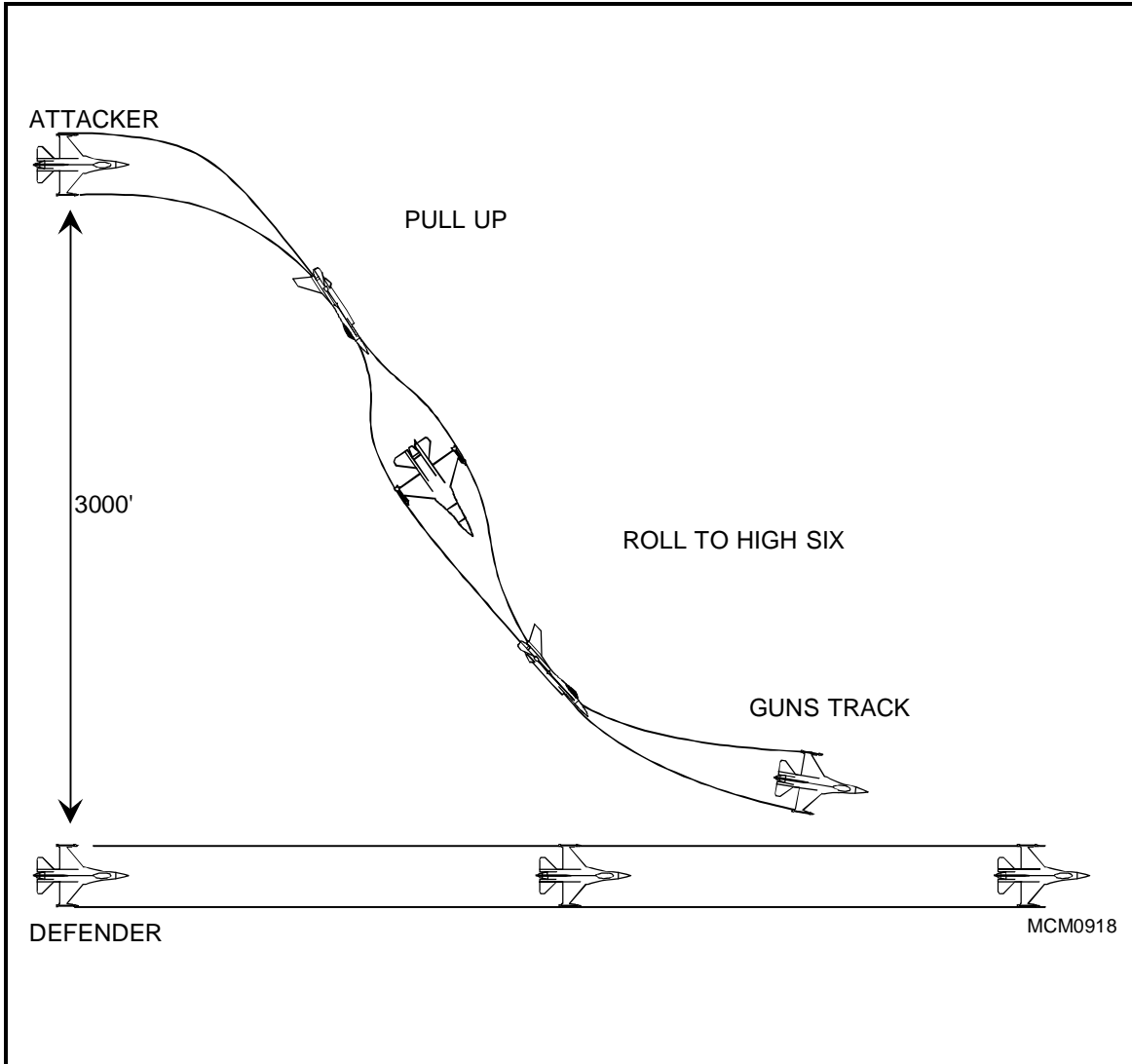
Begin the maneuver by flying line abreast, 4000' - 6000' apart, 350 - 400 KCAS (Figure 9.17). Each aircraft will call "ready." The flight lead will call "Begin maneuver." The defender will then make a 3 - 4 G, 90° level turn away from the attacking aircraft. The attacker will attempt to achieve a valid AIM-9 shot during this turn. After the defender has completed 90° of turn, he may continue or reverse his turn, allowing the attacker to close for either a tracking shot, or a snapshot/separation, as briefed. The exercise will be terminated with a valid gun shot or after the prebriefed objective is attained. Exercise may also transition into cine track exercise as briefed.

This exercise forces the attacker to practice weapons switchology while maneuvering to achieve firing parameters first for the missile and then for the gun. This skill has application in all phases of air-to-air but is particularly useful for teaching defensive two-ship "sandwich" situations. While rapid lock radar acquisition is nice, no-lock self-track shots are definitely a combat-oriented objective with the "sandwich" in mind.

#### 9.5.1.7. Vertical Roll to Six (Snatch Back)

With the defender flying straight ahead, the attacker obtains 50 to 75 knots of overtake and pulls up to a line abreast position, about 3000' out (Figure 9.18). Once obtaining this position, the attacker pulls into the vertical to stop his forward vector. Once the defender is moving forward on the canopy, the attacker rolls to the defender's high six. The last portion of the roll is unloaded. Once behind and above the defender, the attacker settles into a guns tracking position, ideally 1000' - 1500' behind the defender.

This maneuver allows practice of rolling maneuvers and the use of combined G and roll rate to maneuver from a neutral to an offensive position.



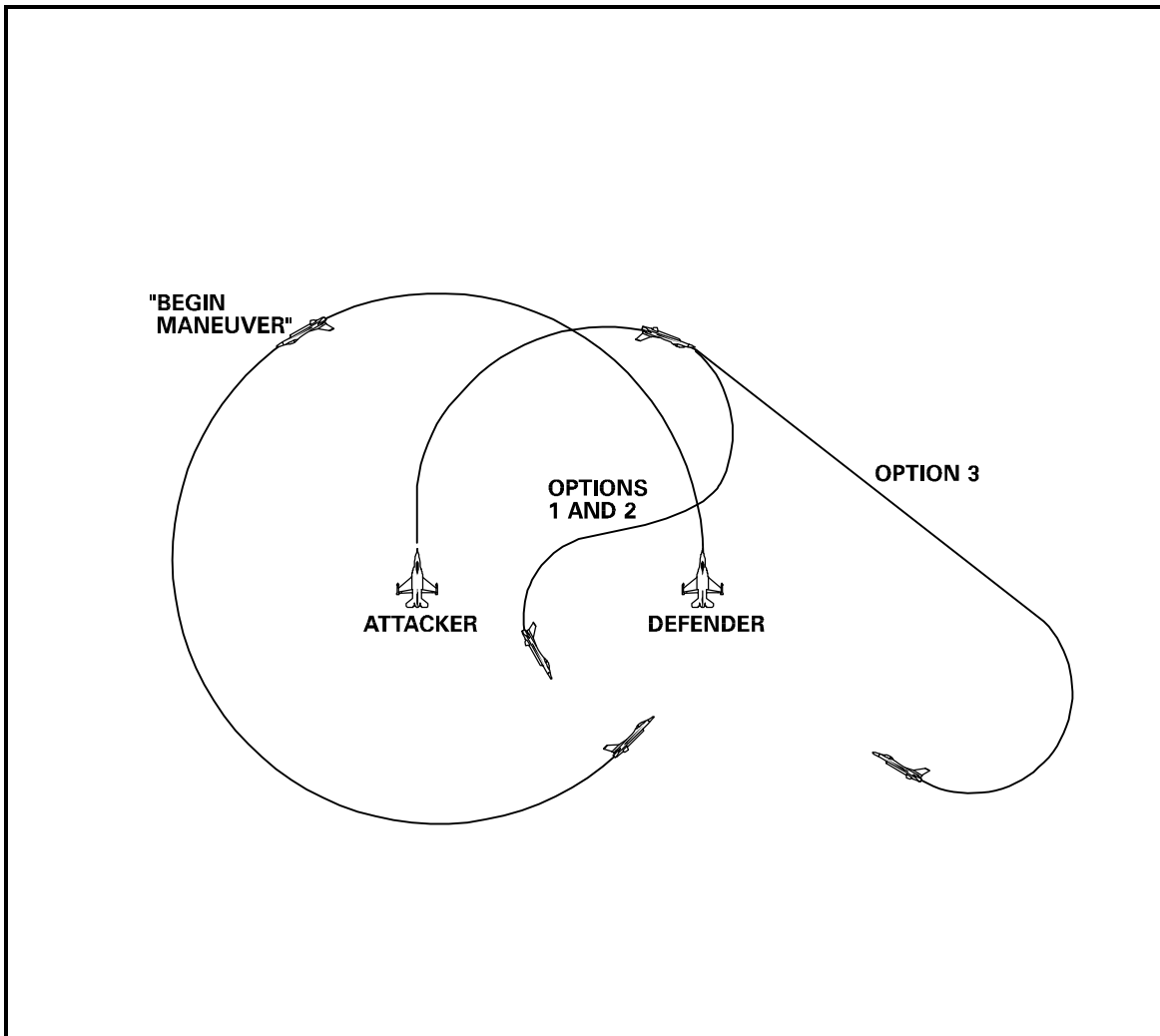
**Figure 9.18 Vertical Roll to Six**

#### 9.5.1.8. Cross Turn Exercise

The exercise starts with a line abreast formation, wingman 5000' - 7000' out (Figure 9.19). The flight lead initiates the exercise by calling "cross turn" and a normal, MIL power, 3 - 3.5 G cross turn is performed, except that at approximately 120° of turn the leader calls "cleared to maneuver." At the cleared to maneuver call, the attacker attempts to attain an entry to Fox II or guns parameters while the defender continues his 3 G turn. The attacker attempts to get his shot prior to the defender completing 360° of turn. KIO at the shot call. The attacker basically has three avenues to arrive in shot parameters: 1) An immediate pitch to point and drive inside the defender's predictable turn circle, followed by a slice into weapons parameters (high to low entry); 2) An immediate slice to point and drive inside the defender's turn circle, pitching up into weapons parameters (low to high entry); 3) An unloaded extension for lateral turning room (approximately 3 seconds) followed by a pull to point at the defender in weapons parameters (belly entry).

This exercise teaches the prediction of a bandit's turn circle and recognition of sufficient turning room and lead turning.



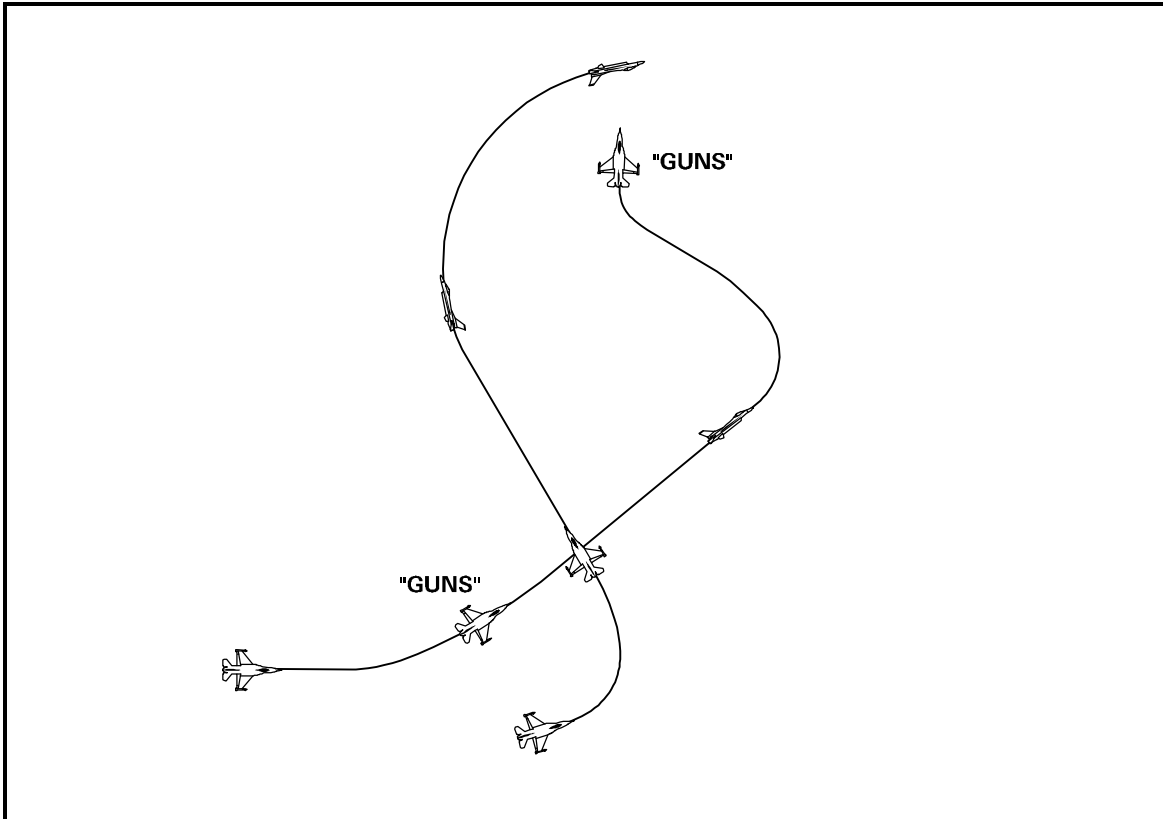


**Figure 9.19 Cross Turn Exercise**

#### 9.5.1.9. High Aspect Gun Exercise

Start at 15,000' - 20,000' MSL, 400+ KCAS (Figure 9.20). The attacker should be 9000' behind the defender, offset far enough to the side so the defender can maintain sight throughout the exercise. The defender initiates a 6 G, level, MIL power turn into the attacker. The defender pulls as required to place the attacker forward of 90° of aspect. (The lift vector is 90° of aspect. Placing the attacker in the HUD equates to 180° of aspect. The defender places the attacker between the lift vector and halfway to the HUD, resulting in 90° - 135° of aspect. Remember that 90° of aspect is the most difficult shot, as it requires the greatest amount of lead angle, and has the highest LOS rate.) The attacker remains in plane with the defender, and closes toward the defender for a high aspect shot. The defender plays the G as required to maintain 90° - 135° of aspect. The attacker should be able to take his shot by 3000' - 5000' out, assuming the defender is at greater than 90° of aspect. Once the shot is taken, the attacker rolls wings level and passes behind the defender. Both aircraft unload and extend away from each other. As both aircraft approach 9000° of separation, they initiate a turn toward each other. The defender again pulls enough G to place the attacker at 90° - 135° of aspect. The attacker again closes for a high aspect shot. (The above sequence can normally be repeated 3 -4 times before getting low on airspeed and altitude.)

This exercise offers the opportunity to practice using many of the sight's features to accomplish a high aspect gun shot.



**Figure 9.20 High Aspect Gun Exercise**

## 9.5.2. Missile Exercises

### 9.5.2.1. Random Missile/Gun Exercise

This exercise (same as roll-slide) is designed to allow the latitude of "playing the piccolo." While the defender may go straight ahead or randomly turn into you or away from you, you will cycle through the AIM-9L/M/P and gun modes to make the appropriate pass. Each pass normally starts from 6000' line abreast. Turn in and take whatever shot(s) are available. If the target turns into you, cycle from a missile mode to a guns mode, as necessary. Once the pass is complete, you simply float to the other side and begin again. Be constantly aware of the min-range bubble and maneuver as necessary to abide by it.

### 9.5.2.2. Defensive Awareness Exercise

The flight begins from a perch setup. The attacker calls "in" and the defender should enter a level turn at 3 - 4 G's using power to maintain 400 KCAS. The attacker will perform various offensive maneuvers. The defender maintains the turn, maneuvering as necessary to keep sight during overshoots and practices defensive ranging. After one or two complete turns, the attacker calls "cleared to reverse." At this time, the defender reverses and varies G-loading as necessary to maintain a visual.

## 9.6. Low Altitude Training

This section includes a discussion of low altitude hazard awareness and low altitude step down training. Several types of maneuvers have been developed to acquaint you with maneuvering in the low altitude arena. Your unit will have a low altitude step down training program consisting of both academics and flying. The following exercises are provided both for practice and optional low altitude awareness training events. A description of the F-16 low altitude warning is also provided.

### 9.6.1. Descent Awareness Training

This exercise gives you an appreciation of the amount of altitude that may be lost in a short period of time due to inattention or channelized attention at low altitude. Beginning at 1000' AGL or higher and

420 - 480 KCAS, establish a wings level 1° nose low descent. Time how long it takes to lose 100', 300', and 500' of altitude. Repeat the exercise with a 3° descent and again with a 5° descent. Do not descend below the minimum altitude established for the route/mission you are flying. Reference Table 9.1 for examples of time to impact in a wings level descent.

DIVE ANGLE	ALT AGL	KTAS		
		400	450	500
1°	700	59.5	52.9	47.6
	500	42.5	37.8	34.0
	300	26.1	23.2	20.9
3°	700	14.2	12.6	11.4
	500	19.9	17.7	15.9
	300	8.5	7.6	6.8
5°	700	11.9	10.6	9.5
	500	8.5	7.6	6.8
	300	5.1	4.5	4.1
10°	700	6.0	5.3	4.8
	500	4.2	3.7	3.3
	300	2.6	2.3	2.0

**Table 9.1 Time to Impact (Seconds) Wings Level Descent**

#### 9.6.2. Level Turn

This exercise gives you practice at maintaining altitude while maneuvering in turns at various bank angles and G loading. Beginning at 500' AGL, 420 - 480 KCAS, establish bank angles between 30° and 90° and set G to maintain level flight. Monitor the HUD flight path marker, altimeter, and visual cues to maintain level flight. Correct drops in altitude by first decreasing bank and then increasing G. With practice, you should be able to perform a 360° level turn using 5 - 6 G's without varying altitude more than +100' and -50'. If authorized, repeat this exercise at 300' AGL. Reference Table 1.2 for examples of time to impact in overbanked turns.

	ALTITUDE	Bank/G required for level flight		
		75°/4 G	79°/5 G	81°/6 G
5° Overbank	500'	12.0	9.8	8.5
	300'	9.2	7.0	6.1
	100'	4.3	3.8	3.3
10° Overbank	500'	7.0	6.2	5.4
	300'	5.2	4.5	4.2
	100'	3.0	2.6	2.4
15° Overbank	500'	5.5	5.0	4.5
	300'	4.3	4.0	3.8
	100'	2.2	2.0	1.9

**Table 9.2 Time to Impact (Seconds) in Overbanked Turns**

### 9.6.3. CAT III Maneuvering

This exercise shows the airspeed and angle of attack effects of sustained maneuvering in a high drag/heavyweight configuration and is more pronounced when flown at gross weights of 30,000 pounds or greater. At 1000' AGL or greater, perform a MIL power 180° level turn using 5 - 6 G's, starting at 420 - 480 KCAS. Note the airspeed loss and AOA increase during the turn. Do not slow below the low altitude minimum airspeed. After performing the turn in MIL power, select AB and accelerate to 420 - 480 KCAS. With full AB selected, perform another 180° turn at 5 - 6 G's. Note airspeed and AOA changes during this turn and compare them with the MIL power turn.

### 9.6.4. Turning Room Demonstration

This exercise enables you to visualize the horizontal turning room required for the F-16 to complete a low altitude turn at employment airspeeds. At 500' AGL or greater, 420 - 480 KCAS, fly perpendicular to a known ground reference line (road, railroad, power line, river, etc.). As you approach the reference line, perform a level 4 - 5 G turn using cockpit and outside visual references so as to roll out exactly over the reference line. Repeat this exercise until you no longer overshoot or undershoot the reference.

### 9.6.5. Vertical Jinks

Beginning at or above 400 KCAS, pull to a planned climb angle, not more than 30°, delay 3 - 5 seconds, roll unloaded to inverted and pull through level flight to a dive angle 10° less than the highest climb angle attained. Roll upright, hold the same delay as in the climb, and pull to straight and level. (NOTE: Use the HUD pitch ladders to reliably determine dive angles. Use caution with high pitch rates because rapidly moving pitch lines are often difficult to read.) Accomplish multiple jinks up to 30° and attain flight path angles within  $\pm 2^\circ$  and match all climb and dive delays within 1 second. This may also be accomplished in the oblique with a planned offset turn/bank. Minimum recovery altitude is 1000' AGL.

### 9.6.6. Reversals

Begin at planned altitude, level flight and 400 KCAS minimum. The IP/FL calls "(Callsign), left/right turn," check turns, comeback calls, etc., to initiate level turns. Emphasis must be placed on awareness of overbank and subsequent descent potential. Roll rates will be smooth and controlled with bank angle stabilized momentarily at 45° and 60° before proceeding to 3 and 4 G's.

### 9.6.7. Acceleration/Deceleration

Starting at 350 KCAS, accelerate in AB to 500 KCAS at 500'/300' AGL. Maintain altitude while decelerating with speed brakes and then idle power until 300 KCAS. Select MIL power, close speed brakes, and accelerate while maintaining altitude.

### 9.6.8. Visual Lookout Exercise

This is designed to train pilots to visually clear the six o'clock area while maintaining a low altitude profile. From straight and level flight at or above 500' AGL and 400 KCAS, keep track of IP/FL position as he maneuvers in a 45° cone 2000' to 2 NM behind, from level to 4000' high on the trainee. Strong emphasis must be placed on altitude, terrain changes, trim, stick pressure when looking aft, and task prioritization while checking six. The pilot must remain within  $\pm 50$  KCAS with no descent rate. The pilot should also be able to visually keep track of IP/FL position and estimate range within 1000'. Do not sacrifice aircraft control to maintain the tally!

### 9.6.9. S Turns

This is a series of banked turns linked by unloaded reversals as defensive reactions to ground threats. Establish level flight and 400 KCAS minimum, roll to 60° - 70° of bank and make a level turn away from the threat. Continue the turn for 90°, perform an unloaded reversal to 60° - 70° of bank and continue turn for another 90° of turn. Perform an unloaded reversal and turn to the original heading. Altitude control should be within +100'/-25' of starting altitude.

#### 9.6.10. Orthogonal Sam Break

From straight and level flight, 400 KCAS minimum, initiate a level hard turn to place the simulated threat at 3 or 9 o'clock. Simulating threat acquisition, start a hard out-of-plane pull perpendicular to the intercept axis of the threat. The perpendicular pull resembles part of a barrel roll as you continue to pull and roll to keep the threat at 3 or 9 o'clock until threat overshoot. At low altitude, once your nose approaches the horizon or if you reach 120° of bank, stop the maneuver and perform a recovery. Minimum altitude for recovery is 500' AGL.

#### 9.7. Flame-Out Approach (FO) Techniques and Procedures

A flamed-out approach may be anything from a 360° overhead to a straight-in approach. It is entirely a function of available potential energy versus distance, with certain modifiers such as the nature of the emergency, weather, airfield conditions, etc. The overriding consideration, of course, is the safe recovery of "the world's hottest fighter pilot," with "the world's most capable and awe-inspiring fighter" a distant second. It is, therefore, extremely important to recognize when recovery of the airplane is no longer feasible so that safe recovery of the pilot can be employed as early as possible to increase the odds for survival. Do not commit yourself to a dubious or unsafe approach under any circumstances. When in doubt, jump out. The good news is that it is relatively easy to determine whether you're within valid flame-out parameters as long as certain basic criteria are met.

A flamed-out F-16 has the capacity to cover a finite distance over the ground based on altitude, aircraft configuration (weight and drag), winds, and field elevation. Assuming that the best glide speed for the aircraft configuration is maintained, the only significant variable to be accommodated is the wind. A flamed-out F-16 with the EPU running maintains a full-up computer navigation system with flight path marker and pitch lines. Since the flight path marker takes winds into account and the best glide speed for the configuration generates an optimum glide slope, it is then only necessary to determine where the recovery field is relative to the flight path marker to determine if the approach will be successful. If the field lies beyond the flight path marker, the approach will be short and ejection should be considered. If the field lies short of the flight path marker, excess energy is indicated which may accommodate a variety of successful approaches and landings. The overhead approach affords the most opportunities to properly manage available energy while providing the best visual clues for pattern corrections. With reference to the HUD, however, the straight-in approach can also be a viable alternative.

##### 9.7.1. Straight-In Flame-Out Pattern And Approach

In the Dash 1 discussion of a straight-in SFO, we're told to maintain an optimum speed gear-up glide until the initial aimpoint on the runway is 11° - 17° below the horizon, then lower the gear and continue the glide at optimum gear-down speed. Engine-out tests at Edwards AFB resulted in a gear-down best range glide between 10° and 11° flight path angle which could be steepened to 17° flight path angle with the speed brakes; thus the 11° - 17° window for lowering the gear. The Dash 1 doesn't include HUD techniques for the FO, nor does it discuss the effect that a headwind or tailwind will have on the 11° - 17° flight path angle window. Experience has shown that energy can be managed most effectively with reference to the HUD flight path marker and pitch lines WHILE MAINTAINING OPTIMUM AIRSPEED.

The flight path marker accounts for wind. For every 20 knots of headwind component, the flight path marker will show about a 1° increase in flight path angle (aircraft pitch/AOA to maintain optimum airspeed does not change). Establish and maintain optimum airspeed for the configuration. The HUD will then accurately depict where your optimum flight path will take you, all variables accounted for. Regardless of actual flight path angles involved, lowering the gear will increase the flight path angle 3.5 - 4°. When the engine quits, jettison stores and turn toward the nearest suitable runway. Establish best range speed of 210 KCAS (plus fuel/stores). Trade excess airspeed for altitude. The EPU should be on and, if the engine is windmilling with aircraft fuel available, the JFS should be turned on below 20,000' MSL to extend EPU operating time (10 minutes with normal demands; up to 15 minutes with the JFS running). The JFS will also provide B system hydraulic pressure for normal gear extension, normal brakes and nosewheel steering. With an optimum glide established, if the flight path marker is on the runway or beyond and optimum speed is maintained, the threshold will slowly move downward in the

HUD field of view indicating excess energy (in terms of altitude) for the approach. This is **good** because sooner or later the initial aimpoint (1/3 of the way down the runway) will lie within the gear-down window. The gear may be extended when the aimpoint is between 11° and 17° and landing is assured.

If EPU fuel depletion is a factor because of range to the runway, consider a 10° gear-up glide when the best range glide has given you a 1:1 ratio between altitude in thousands of feet and range to the runway (i.e., 20,000' AGL at 20 NM). Airspeed can be increased to 300 - 330 knots, cutting time required to reach the runway and reducing EPU fuel used (see paragraph on "IMC Penetration" in Dash 1 FO procedures). When the gear is lowered (alternate extension required unless the JFS is motoring the engine), continue the glide at best range (gear down) speed. Use speed brakes as required to maintain the desired glide path and airspeed parameters, and achieve a steady-state optimum gear-down glide prior to the flare point with the flight path marker on the aimpoint. In a nutshell, if you flame out, regardless of altitude or distance out (within EPU fuel constraints), and the recovery field is below the 7° pitch line, you immediately know you can get there. Winds can affect this equation.

Unless you confirm an energy surplus, it is extremely important to maintain optimum speeds throughout the approach. Excessive airspeed will increase the glide path angle and consequently decrease range. Low airspeed will do the same thing, in addition to providing progressively less energy to flare the aircraft or zoom to safe ejection parameters. Below the gear down minimum speed, the flight path marker shifts dramatically towards you (short), and energy may be insufficient to flare and touch down without damaging the aircraft, or worse. There is no way to "stretch" the glide. If the aimpoint shifts upward in the HUD field of view beyond the flight path marker, this indicates that you will not be able to make the runway. Ejection should not be delayed in a futile attempt to salvage a questionable approach.

If you've managed your energy to achieve an optimum gear-down glide with the flight path marker on the initial aimpoint, the only chore remaining is to flare and land the aircraft so that you touchdown between 10° and 13° AOA with enough runway remaining to get the jet stopped before running out of runway or cables. Once landing is assured, the recommended procedure is to shift the aimpoint from 1/3 down the runway to a position short of the intended touchdown point. Techniques presented here will consistently produce touchdowns at 2500' to 3000'. If a shorter touchdown is required, simply adjust the optimum glide aimpoint an appropriate distance short of the threshold. The trick is to transition from a "steep final" to a touchdown flight path angle of less than 2°. If the flare is too abrupt or begun too early, you will run out of airspeed prior to touchdown. The result will be an excessive sink rate and probable damage to the jet. The opposite is also true. You can't hit the runway in a 10° dive and expect good results.

With practice, a simulated flameout flare will become second nature. Meanwhile, there's an easily remembered set of parameters which will approximate what you're looking for and help you avoid the extremes mentioned above. At about 300' AGL, start a smooth flare. This will give you a picture similar to a normal final and get you into ground effect with enough energy to complete the flare (hold it off if necessary) and grease it on at 10° to 13° AOA. The speed brakes should normally be closed at this point. Use them if you need them but realize they will dramatically increase energy decay if extended during normal roundout and flare.

If your energy state (glide slope/altitude with respect to the runway) is too great to be managed with speed brakes alone, dive off altitude or modify the ground track. Use caution when employing either of these methods. It is very easy to overdo the correction since either method may involve removing the runway environment from the HUD field of view during the correction. The overhead approach may be entered at any position provided the proper altitude for that point in the pattern can be obtained. The main concern is to reach high key, low key, or base key at or above prescribed minimum altitudes.

#### 9.7.2. Overhead Flame-Out Pattern Approach

For an overhead approach, plan to arrive at an appropriate high key altitude based upon aircraft gross weight. At high key in the landing configuration, turn to downwind/low key at approximately 60° of bank and constant airspeed, optimizing the F-16's turning capability and minimizing altitude loss. By using a 60° bank turn, you will be able to spend more time wings-level and assess your energy state more easily. If off conditions at high key, adjust the pattern as necessary (delay landing gear if low, extend down the

runway if high) to achieve low key parameters. Delaying landing gear until low key will decrease altitude loss by 1000' - 1500'. If on conditions, continue downwind until the touchdown point is 10° - 45° aft of abeam, depending on wind. Fly the final turn at optimum airspeed (9° - 11° AOA) and, after rolling out on final, maintain airspeed with nose low, setting the flight path marker short of the runway threshold until pre-flare. Use speed brakes as required on final to control airspeed. The ground track of the overhead approach is approximately the same as that of a normal overhead landing approach except the final approach will only be 0.5 NM long. Expect the aircraft to float 3000' - 4000' horizontally before touchdown at 10° - 13° optimum.

After meeting low key parameters, you will usually be high and steep on final unless you adjust in the base turn. If this is the case, use pitch and speed brakes as required to arrive at the round-out point with a 10° flight path angle. In the absence of a positively recognized energy advantage, maintain an optimum airspeed until you ascertain that your 10° aimpoint is on the threshold or close enough to it to place your touchdown point on the runway surface. If it isn't, it is time to eject. **Do not** pull the flight path marker up to the runway in an effort to lengthen your aimpoint. The resultant loss of airspeed may preclude a successful round-out and flare. When you are about 300' AGL, employ the same flare technique as you did for the straight-in approach.

Procedures for an SFO are identical to an FO with one minor exception—the engine is still running during an SFO. Crack open the speed brakes slightly and put the power to idle for an SFO. On wings-level final, speed brakes help control energy during the flare and touchdown. In the overhead pattern, call "high key," and "base key, gear down" with intentions. For a straight-in, call "straight-in SFO" with DME when commencing the approach and "gear down" with intentions when appropriate. Always check engine response no later than low key or equivalent. If it's still running, continue to a low approach. If it isn't, land. Do not, however, use the engine check to salvage a bad approach. The only person you're kidding is yourself. If you arrive at the round-out point with less than the desired energy state, take it around and try again. Don't try to salvage a bad approach under any circumstances. Learn from the mistakes you've made instead of compounding them by flying into a "square corner." During the terminal stages of the approach, use no more than 10° nose low by 300' AGL as a guide to go around. These numbers are action points, not decision points, and do not include a pad for reaction time.

---

## Chapter Ten

### LANTIRN

#### 10.1. The LANTIRN System

The LANTIRN system greatly enhances the capability of the F-16. This chapter focuses on LANTIRN specific considerations. The major areas covered are mission planning, ground operations, TFR in-flight checks, en route cruise checks, TFR modes of operation, low level operations, low altitude LANTIRN attack options, multiple attacks, medium altitude ingress/ attacks, and the RTB phase. MCM 3-1, Dash 34 series, and appropriate 11 and 55 series regulations should be consulted to further supplement this manual.

#### 10.2. LANTIRN Effects on Performance

##### 10.2.1. Increased Drag/Decreased Performance

The F-16 LANTIRN configuration includes a navigation pod (NVP) and a targeting pod (TGP). Each pod weighs approximately 500 lb. and adds an additional 25 units of drag for a total increase of over 1000 lb. and 50 units of drag. During mission planning, ensure adequate fuel is available, achievable cruise altitudes are selected that don't require AB, and realistic ingress airspeeds are selected. Threat reactions, turns, climbs, and attack profiles will quickly reduce performance below an acceptable level if sufficient airspeed is not maintained and/or acceleration lead points are not established. This is more apparent in the block 42, PW220 equipped aircraft than in the block 40, GE100 equipped aircraft.

### 10.2.2. Turn Radius/Limited Turn Capability

When flight with LANTIRN at low altitude is conducted within TF limits, turn radii increase dramatically over typical daytime navigation turns. Plan turns using 45° of bank to ensure they can be accomplished within TF limits. Turns into terrain will further limit turn capability. The turn radius must also be used when drawing your map to aid in route study of where the aircraft is actually going to fly. For turns where large heading changes are required, it may be desirable to plan to lead the turn in order to roll out in more favorable terrain. If overflight of the steerpoint is desired, offset from the inbound track opposite the direction of turn. Intermediate steerpoints may be required solely to reduce turns at important points such as the IP.

## 10.3. Route Planning

The LANTIRN system also requires unique pre-mission planning to ensure mission success for day or night employment.

### 10.3.1. Start-route/Letdown Point

Plan to complete all cockpit tasks before descent at the start route point. Consider using altitude deconfliction until past the start route point. Whenever possible, enter the low level regime over an easily identifiable point. Flat terrain allows a smoother transition to low altitude.

### 10.3.2. Steerpoint Selection

For low altitude operations, avoid excessively long legs. If circumstances dictate longer than 10 minute legs, consider a midpoint position/altitude update point (OAP).

Note the type and height of all man-made obstacles within 5 NM of the course centerline at 75% or greater of the SCP and indicate the distance to the next steerpoint. Determine the RAA for the entire route and the MSA for each leg/or segment of a leg (IAW MCI 11-F16 Vol. 3).

### 10.3.3. Steerpoint Qualities

In selecting a navigational steerpoint or OAP, evaluate its IR, radar, and visual qualities, and the availability of offset aimpoints.

#### 10.3.3.1. IR Qualities

The steerpoint should be an easily identifiable IR source. It should be isolated and have a high Delta T. Both background and steerpoint clutter should be minimal. The object should have good vertical development for low altitude and be a large, yet definitive, point for medium altitude so it can be easily acquired. Some examples of good steerpoints include points of land in a lake or on the far shore, water towers, unambiguous isolated structures, airfields, and isolated mountain passes. Some examples of bad steerpoints include the near shore of a lake, most hilltops in rolling terrain, roads in forested terrain, cluttered structures, power lines, and small radio or microwave towers.

#### 10.3.3.2. Radar Qualities

The steerpoint should be radar significant. Radar clutter should be minimal at the steerpoint.

#### 10.3.3.3. Visual Qualities

A good visual steerpoint requires artificial lighting at night. It should also be visible from several miles out.

### 10.3.4. Coordinates

Navigation to the target must be very precise when using LANTIRN. GPS provides this precision and reduces cockpit tasking. If GPS is not available, you must rely upon the INS, radar, TGP, and FLIR. The most precise coordinates available are called mensurated coordinates. These are obtained from the Defense Mapping Agency through intelligence channels. Other sources of accurate coordinates include satellite photography or 1:50,000 charts. Since GPS uses the WGS coordinate system, you should use coordinates with the same WGS datum base. If you use maps with other datum planes to derive coordinates, use similar maps for determining all coordinates and convert to the same WGS datum plane using approved computer programs. Remember that the key is the combination of INS accuracy with



precise coordinates and elevations. The daytime capability to recover at a turn point "down the road" is gone. You cannot afford to corrupt the navigation system with coordinates derived from different and less reliable sources.

### 10.3.5. Environmental Considerations

#### 10.3.5.1. Weather

Weather greatly affects the IR scene and IR seeker performance. Clear skies, precipitation, clouds, wind, and previous weather affect FLIR detection ranges and laser performance.

#### 10.3.5.2. Clear Skies

At night, rapid radiation cooling increases thermal contrast. Targets and backgrounds with low thermal inertia cool rapidly at night. Those with high thermal inertia retain much of the heat gained during the day.

#### 10.3.5.3. Precipitation

Water vapor in the form of rain, snow, clouds, and fog, absorbs IR radiation and scatters thermal energy, thereby reducing acquisition range. Rain and snow reduce the transmission of IR energy and decrease apparent delta T. Delta T gradually decreases as precipitation continues to fall. Falling precipitation restricts IR detection more severely than that which has already fallen. Solar and frictional heated target features suffer the most heat loss. Frictional heat loss is caused by water and mud accumulating on tracks and wheels. Heated areas stand out more clearly against cool and washed-out backgrounds. Rain affects horizontal surfaces more than vertical surfaces. Rain effects are magnified by the types of material in the target area. Porous materials soak up water and take longer to dry than nonporous materials. At low viewing angles, snow reflects the sky temperature and appears cold on the display. Under clouded skies, at low altitude, snow reflects warm clouds, which emit absorbed solar radiation. Snow appears warm under this condition. Previous weather can have a tremendous impact on thermal contrast and must be considered in mission planning. A recent rain or snow can wash out the thermal contrast of the target and background. Rain showers also have an adverse effect on TFR operations. If the precipitation is heavy enough the TFR may interpret it as terrain and command a fly-up. Use of the WX mode whenever rain is forecast will reduce, but not eliminate, fly-ups. Avoidance is the key. Use the forecast, other aircraft, and avionics to avoid having to route abort into a shower.

#### 10.3.5.4. Clouds

Clouds directly affect LANTIRN operations since they can block IR energy. Cloud free LOS is required to see the target. When using the TGP, LOS must be maintained or the TGP track will be broken and force a miss or force you to reacquire the target. An overcast can also greatly effect the IR visibility beneath it by reducing temperature contrasts.

#### 10.3.5.5. Wind

Wind reduces the delta T between the target and background. The higher the wind speed, the less the delta T. Targets and backgrounds with low thermal inertia are more sensitive to wind than those with high thermal inertia. The greatest change in temperature occurs when wind speed increases from zero to five knots. Wind also affects LGB delivery and trajectory during the terminal phase. For detailed information on wind affects on the LGB reference the classified Dash 34 series.

### 10.3.6. Tactical Decision Aid

The tactical decision aid (TDA) is used by the base weather forecaster to assist you in IR mission planning. This discussion covers what the TDA is, TDA models, inputs, outputs, acquisition and lock-on ranges, and how to use the TDA.

The TDA uses three computer models: the target contrast model, the atmospheric transmission model, and the sensor performance model:

- *Target Contrast Model* estimates delta T, or thermal contrast, between the target and background. It uses this data to predict how far away the IR sensor should see the target and the background contrast.

- *Atmospheric Transmission Model* predicts how well target contrast is transmitted through the atmosphere.
- *Sensor Performance Model* describes how well each sensor works over a specified portion of the electromagnetic spectrum. Given the target signal that reaches the sensor, the sensor performance model yields a range at which the sensor can detect, and if applicable, lock-on to the target.

The weather forecaster inputs your pre-mission intelligence data to the TDA to determine the output for each of the models. This data is of three types: mission information, tactics information, and target information.

- *Mission Information* includes the date and time of the mission, the times over navigation points and targets, the type of IR sensors used, and type aircraft.
- *Tactics Information* includes altitudes, headings, aimpoints, ingress tactics, employment tactics, and egress tactics.
- *Target Information* includes target location data, target composition, and background data. Target location data includes target latitude, longitude, elevation, and orientation. Target composition data includes color, thickness, condition of the exterior, and construction materials. Is it heated? Does it generate heat? Are there areas that stand out as conspicuous hot spots, such as smokestacks and cooling towers? Are there areas that stand out as conspicuous cold spots, such as air conditioning ducts, metal roofs, and settling ponds? Lastly, is the target covered by earth or concealed in other ways such as by camouflage nets? Background data includes the type of vegetation, soil type and characteristics, roads or other landmarks near the target, terrain or vegetation that can obscure the target, bodies of water in the vicinity of the target, and background slope direction.

After the forecaster inputs your mission intelligence data, his next step is to determine target area weather, target and background categories, and atmospheric transmissivity.

The final TDA outputs provided by your weather forecaster are the acquisition and lock-on ranges. TDA forecast ranges tend to be conservative. Generally, the lower the transmissivity the higher the FLIR gain control setting you should expect to achieve consistent results.

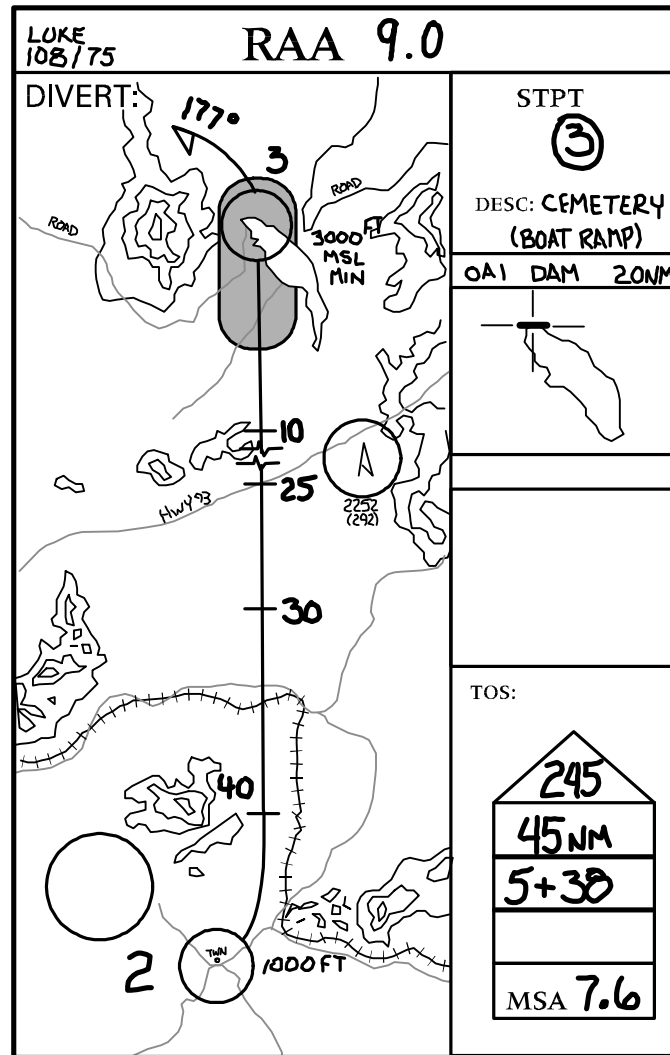


Figure 10.1 Stick Chart Example

10.3.7. Stick Charts

Navigating using a typical VFR map becomes unmanageable at night with lower cockpit lighting. Stick charts are used as a refresher to route study. Stick charts do not remove the MCI 11-F16 Vol. 3 requirements to carry a VFR map. Development of a stick chart is an individual process to aid in mission study and in-flight reference. Each pilot has a different idea of what is significant for each leg of the route. However, the minimum items normally included on the map are: times, distances, headings, attack parameters, RAA, MSA, and RIA. Optional data on the stick chart includes: significant points, obstacles, and any required cockpit tasks or useful information. Figure 10.1 shows a typical hand-drawn stick figure map.

10.4. Target Area Mission Planning

10.4.1. Analyze the Target

The first objective in attack planning is to analyze the target. Determine the type of target fraggled for, its characteristics, and location. With this data, we determine at what ranges the target can be acquired with FCR, FLIR, TGP, and/or the IR Maverick seeker.

The first thing to determine is the type of target. This often dictates the type of ordnance and optimum delivery. For IR planning we categorize targets as either vehicular targets, such as tanks or APCs; or high value targets, such as bridges, dams, and rail junctions. Specific points or references are used to identify area targets.

Next, we determine the target's characteristics. These are essential to determining how the target will appear on radar, in the FLIR, TGP, and in the IR MAVERICK display.

Determine target dimensions. At low altitude, vertical development is very important to radar and IR acquisition, as well as TGP acquisition and ability to track at low graze angles. At medium altitude, vertical development is less noticeable except for distinct terrain edges (same criteria for choosing DBS aimpoints). Offset aimpoints should be considered for small targets.

Determine target orientation. This is a critical factor for weapons employment. When possible, plan the attack axis to see the largest target cross section to aid in early acquisition.

Determine what the target will look like from your specific attack profile. The ideal target will be visible to both radar and IR. A target that has good vertical development provides longer range detection at lower altitude.

Target location is important for three reasons. First, we need to know its precise geographical location for navigation. Secondly, we need to analyze the terrain in the vicinity of the target to determine obstacles to navigation and weapons employment. Thirdly, we need to analyze the terrain in the vicinity of the target to determine the target and background thermal contrast. Evaluate target area charts and photos to determine the type of terrain in which you will be operating. Tanks moving through a heavily wooded area may be readily identifiable in the IR scene, but may also be more difficult to destroy. Fixed targets constructed of materials comprising the surrounding area may be difficult to see with the FLIR sensors. With level smooth terrain, targets are generally readily identifiable and maneuvering the aircraft is relatively easy. Mountainous terrain, on the other hand, is difficult for low altitude operations, especially at night. Targets are more difficult to acquire and track. Maneuvering at low altitude in mountainous terrain at night is considerably more difficult and dangerous, due to the turn rate limitations of TFR operations. Both natural and man-made obstacles in the target vicinity should be noted. Any restrictions these obstacles place on maneuvering with or without the TFR should be noted. Also, the obstacles should be evaluated for any impact on selecting an attack axis. Another consideration is any impact the obstacles may have on the IR scene, relative to the LOS to the target.

#### 10.4.2. Acquisition Ranges

Acquisition range depends on how target is acquired (FCR/TGP, NVP FLIR, Maverick, or visually) and determines the maximum range at which you can expect to safely and accurately deliver the weapons.

##### 10.4.2.1. Radar Acquisition Range

Target dimensions, especially the vertical dimensions, determine the maximum low altitude acquisition range. The maximum acquisition range presumes an unrestricted LOS. Therefore, when selecting an attack axis, you must exclude approaches that restrict radar acquisition within 10-12 NM of the target or select offset aimpoints.

##### 10.4.2.2. TGP/NVP FLIR Acquisition Range

As predicted by the TDA, FLIR acquisition range is determined by the target to background contrast and atmospheric transmissivity of vehicular and high value targets. Vehicular targets should be evaluated for both the operating and non-operating states. In the operating state, a vehicle should be the hottest object in the scene. The hot spot of an operating vehicle has to be considered, but only in respect to its position in the vehicle. The aspect angle of an operating vehicle is not material to the selection of an attack axis, unless it can reasonably be predicted. An example of an aspect angle that can be predicted is a column of tanks passing through a choke point. In this case the hot spot aspect angle may determine your attack axis, all other considerations equal. In the non-operating state, a vehicle is treated like a high value target. If the type of vehicle is not listed in the TDA, a close substitute must be selected. High value targets are all non-vehicular targets. You should determine whether or not these are internally heated. If capable of internal heat, you can expect a good heat source if attacked on the appropriate axis. If the

target is not capable of internal heat, then the TDA must be run to acquire the optimum delta-T based upon the target's orientation with the background.

#### 10.4.2.3. IR Maverick Acquisition Range

Acquisition and lock-on ranges are based upon the same IR principles as the FLIR. Experience has shown that an operating tank can be acquired at 9 NM when both the temperature and humidity are low.

#### 10.4.2.4. Visual Acquisition Range

At night, a lighted target may be recognizable beyond even radar acquisition range. Unlighted targets may also appear at near daylight ranges on a clear moonlit night.

#### 10.4.3. Attack Axis

In selecting the optimum attack axis, you must consider target aspect, how the target will appear at ingress, the threat, and obscurants.

##### 10.4.3.1. Target Aspect

Determine attack axis to account for target aspect. Attack the target from a direction that provides the greatest profile for the longest radar and IR acquisition ranges. The attack axis must provide the best LOS. Terrain masking and local area masking should be evaluated to aid in determining the attack approach altitude. LGB deliveries must account for the effect target aspect has on the laser spot movement throughout the delivery until weapon impact. This includes two problems, both based on the podium effect. The podium effect is when the laser spot changes "sides" of an object based on laser designation movement. The laser spot is initially on the front of an object, but during the turn to egress phase, may move to the side of the same object. Since the LOS of the PGM is still on the front of the object, the PGM may not "see" and guide on the laser spot. To avoid this problem, plan attack at a 45° angle to the face of the target. The second problem involves delta T differences between sides of the target. Using point track the targeting pod may drop lock or switch "sides" as the scene changes during the egress phase.

##### 10.4.3.2. Ingress

Attempt to determine how the target area will appear from low altitude based on the selected attack heading and run-in altitude. Masking may alter which cues can be used to lead to the target. Account for vertical development. Objects with the greatest vertical development will dominate the target scene. Use the radar to work from the big picture to the small. Select known points that can be used at the greatest distance in the GM mode. Consider using offset aimpoints and DBS 2. Also look for IR significant references that may provide visual cues to the target. Be prepared for camouflage, concealment, or deception techniques employed on high-value, fixed, and relocatable targets.

##### 10.4.3.3. Threat

Evaluate the threat as for any mission; but, be particularly alert to IR decoys, other CCD techniques, chaff, and TFR jamming.

##### 10.4.3.4. Obscurants

Evaluate the attack axis for areas that might be likely areas for obscurants which might interfere with or interrupt the IR scene. Natural obscurants, such as fog, haze, rain, clouds, and snow, can obscure the IR scene and eliminate any chance of using the FLIR TGP, or IR Maverick at night. Expect man-made obscurants, such as smoke, fire, and decoys in planning the attack. The thermal bubble created by another aircraft's bombs will obscure targets in the immediate area for a short period of time. Separate DMPI's based on wind direction or timing deconfliction is required.

*CAUTION:* Camouflage, concealment, or deception can delay or prevent target acquisition in all spectrums. All available sensors must be used to identify and confirm the target.

#### 10.4.4. IP selection

Include considerations for IR contrast and vertical development if at low altitude. Normally, plan on the IP being approximately 15 NM from the target. This longer leg allows more time for target

identification and updating using the TGP or GM radar. With accurate navigation data (GPS-high accuracy), the IP becomes more of an attack axis alignment than an update or slew point. Plan your point prior to the IP to limit turning at the IP. If terrain or threats prevent this, use turn radius to plan a lead point which allows you to roll out on attack heading prior to the IP.

#### 10.4.5. Type Delivery

Determine the type delivery best suited for the known conditions. Some factors to consider are the type ordnance, weather, and means of target acquisition.

The first determining factor is the type ordnance you are tasked to employ. Conventional munitions require close-in deliveries, unless laser guided using the loft profile. The Maverick standoff range is a function of both aerodynamics and acquisition range.

The TGP and FCR are the primary target acquisition sensors. Acquiring and locking the target with the TGP provides the highest aiming accuracy. Highly accurate deliveries can be achieved by using LGBs.

#### 10.4.6. Delivery Options

Deliveries can be broken down into two general categories: overflight and standoff. The target, weather, munitions, and the threat dictate your delivery options. The TGP provides precision aiming of guided and unguided weapons through its tracking ability and accurate laser ranging. When using the TGP, it is important to track the target prior to weapons release while remaining within TF limits at low altitude. You may have to plan a bump up to gain LOS to acquire and track the target. If overflight deliveries are used, planned and minimum release altitudes are determined to ensure fuze arm and safe escape for a specific safe escape maneuver. The minimum release altitude will vary for level straight through, climbing safe escape, or turning safe escape. Terrain in the target area must be considered in picking the safe escape maneuver to ensure ground clearance. If a turning safe escape is planned, the RIA must be evaluated to ensure the escape turn will not occur below the RIA. In addition, minimum altitude for level LGB deliveries must allow a terminal guidance phase capability (approximately 11 seconds TOF minimum). Level deliveries are a common back up for degraded operations (HUD failure) or late target acquisition. An overflight delivery option using a direct attack pop-up can be used to position the target in the HUD for FLIR acquisition and a CCIP delivery followed by a safe escape maneuver. However, planning overly aggressive maneuvers or minimum time finals will increase the chance of a missed attack. A common technique for night direct attacks is to plan for eight seconds time on final. Stand-off deliveries can also be used by lofting the bombs and then performing a recovery maneuver back to low altitude. When lofting LGBs, plan for a guidance phase which ensures terminal guidance and prevents TGP laser masking. Extreme caution must be used when planning and flying head down tasks to prevent ground impact. For this reason no head down task should be planned or performed outside TF limits. It is highly recommended that AUTO TF be used during these tasks. When employing without a TGP, level and standoff deliveries remain the same except there is no target tracking or terminal guidance available. An overflight delivery option using a direct attack pop-up can be used to position the target in the HUD for FLIR acquisition and CCIP delivery followed by a safe escape maneuver. However, planning overly aggressive maneuvers or minimum time finals will increase the chance of a missed attack.

#### 10.4.7. TFR Use/Safe Escape

You should plan to use AUTO TF as much as possible. Run-in altitudes at higher SCPs in AUTO may increase LOS range to the target and provide full TF protection while using head down displays. The final portion of most attacks or escape maneuvers require out of limit maneuvering (loft, direct pop, CLM, Turning Escape Maneuver- Level Turn). If you roll to beyond TFR global limits in less than 2 seconds, these out of limits maneuvers can be performed in auto TFR without any fly-ups. This technique is safer, easier to perform, and more tactically sound. Recovery maneuvers should be planned as accurately as possible to increase SA about where and how the egress and descent back to low altitude will occur.

#### 10.4.8. Multiple Attacks

It is quite normal to plan and perform multiple attacks during a typical LANTIRN mission, just as you would do during a surface attack tactics (SAT) mission. It is imperative that in-depth planning take place

before flying the mission. Factors to consider include selection of a base turnpoint, MSA computations, and the pattern to be flown.

During mission planning, you need to choose a base turnpoint that will enable you to comfortably turn toward the IP. This turnpoint should be based on how you plan to accomplish the turn. Two techniques commonly used are an in-limits turn below the MSA or out-of-limits turns from the MSA or above. Obviously the pattern altitude that you choose (or are required to use if working on a controlled range) will dictate the type of turn you use. If the pattern altitude will put you below the MSA, then all turns must be within system limits and you must plan a turnpoint that is far enough away from your IP. It must allow you to do an in-limits turn and roll out with enough time to identify the IP through the FLIR, TGP, or FCR. A common technique to aid in the turnpoint selection is to use a combat plotter with turn radius scales for various degrees of bank. The base turnpoint should not be abeam the IP because you want to have time to identify the IP. Most pilots use a point approximately 45° from the IP in the direction of the downwind, and approximately 10-15 NM from the IP. This will provide enough maneuvering room to make auto TF turns and still have time to identify the IP. Another option is to choose a point similar to but less than the distances described above, and make turns outside of system limits at or above the MSA. LANTIRN pilots use two different techniques to accomplish the out-of-limits turn to final. They use either two 90° turns or a 120° turn followed by a 60° turn to final. The technique planned may impact the ideal base turnpoint location and must be used by all aircraft to prevent conflicts in the pattern.

An MSA must be determined and annotated (line-up card, map, and attack sketch) for each leg of the low level, IP-to-TGT, and/or range and egress. MSA may be determined for any length of routing, however it must still encompass 5 NM from any given point/segment along the projected ground track.

The pattern should be large enough to allow for a complete egress to low level without having to do a 180° egress. Once the egress is complete, a common technique is to climb above the MSA to ensure sufficient time is available to adequately prepare for the next attack.

## **10.5. Ground Operations**

The night LANTIRN preflight should not be rushed. It is slower than a normal day preflight because you do not have your normal day cues. The location of the NVP and TGP make movement around the aircraft nose wheel difficult. Preflight of the TGP should ensure that the laser is on the proper setting. Your planning should include an extra 5 minutes for night preflight so you will not have to rush. Ensure that you have checked the LT and RT HDPT coefficients in the 781 and that the fly-up enable switch in the FCP is in ENABLE.

Refer to the ordnance preflight section in Chapter 5. In addition, use a good flashlight to give you a better light source for aircraft and ordnance preflight.

### **10.5.1. After Start**

Ground operations and checklist procedures are relatively the same with the exception of the NVP and TGP. After the SEC and EPU checks, power the avionics panel as normal, Then power the CARA, FCR, LT and RT HDPTs and select STBY on the FLIR/TFR.

Reduce lighting as much as practical to help outside visual cues. However, cockpit lighting during a LANTIRN mission will still be considerable due to the bright video displays of the FLIR, TGP, and Maverick and must be expected. The key is taking the time to set the desired brightness during ground operations to prevent distraction from a bright MFD once airborne.

Verify LT and RT hardpoint coefficients. These coefficients can be found in the forms during preflight. Refer to the discussion on canopy coefficients in Chapter 5. The numbers to be concerned with in LANTIRN are the LT and RT HDPT coefficients. While reviewing the forms, write or remember the numbers and ensure they are in the FCC. They can be found the same way the camera coefficients can be found, just continue to dobber right.

### **10.5.2. BIT checks**

BITs can be accomplished as soon as the "not timed out" messages are out of the MFD displays. Normally it will take 7 minutes for the FLIR, 3 minutes for the TFR, and 7-15 minutes for the TGP to time in.

- *RALT*: The RALT BIT takes 3-5 seconds and the display on the test page will go from 0 to 300. When the RALT de-highlights, the BIT is complete.
- *FLIR*: This takes 15-30 seconds. After FLIR BIT selection, go back to the FLIR page to ensure the BIT takes place. This can be verified by BIT in place of STBY in the upper left hand of the MFD. During the FLIR BIT you will see an IR picture and then the MFD will flash.
- *TFR*: This BIT takes 1 minute. Like the FLIR BIT, after BIT selection go to the TFR page and confirm BIT in the upper left hand of the MFD.
- *TGP*: This BIT takes 80 seconds. This BIT must be performed with the pod unstowed. Upon completion, the pod must be restowed for taxi.
- *Check for Pod Flags*: As soon as all IBITS are complete, have the crew chief check both pods for flags. In case of possible failures, there will be more time to get it fixed.

### 10.5.3. System Checks

- *FLIR Tuning*: Accomplish IAW the Dash 34. A consideration for day/night missions is to carry a HUD bonnet or unit equivalent.
- *FLIR BSGT*: Accomplish IAW the Dash 34. If TGM/AGM 65s are carried, you can use the TD box from VIS/SLAVE instead of the DTOS box as described in the Dash 34. To do this you must also select GND JET ENABLE to get VIS/SLAVE on the ground and make sure you don't have the SOI in the WPN when slewing the FLIR video. Accurate FLIR boresight is possible in the air using a cooperative aircraft as a reference.
- *MAV BSGT*: The TGM/AGM 65 can be boresighted with or without the TGP on the ground. After finishing the boresight, don't forget to adjust the MFD brightness and contrast to keep cockpit lighting down to a minimum and increase the chances for increased detection ranges on the Maverick.

### 10.5.4. Systems Setup

After tuning and boresighting various pods and systems, now go through to ensure all systems are set up for your mission. A recommended technique for setting master modes is:

<b>MSMD</b>	<b>LEFT MFD</b>	<b>RIGHT MFD</b>
NAV	FCR TGP FLIR	SMS TEST TFR
A-G	FCR TGP FLIR	SMS WPN TFR
ALL A-A	FCR	SMS TGP TFR

The reasoning behind this setup is to have FCR and TGP on the same MFD whenever the A-G mode of the TGP is being used (NAV, A-G master mode). This allows one DMS left to switch from FCR to TGP and the SOI will move as well. With FCR and TGP separated on both MFDs, it is very easy to lose track of the SOI, and you will routinely look at something other than the TFR on the right MFD for an extended period of time. You should have the TFR displayed as much as possible—this MFD setup enforces that. Other considerations:

- Delete WPN from A-G if Maverick is not being carried.
- In NAV and A-G master modes, use the A-G mode of the TGP. In A-A modes use the A-A TGP mode.
- Administrative MFD pages such as DTE, TEST, and FLCS can be placed in open slots at pilot preference. However, it is recommended that they not be located in A-A or A-G master modes where they may cause an extra DMS left or right to get to a more important MFD page.
- The specific order on each MFD is not as important as priority. Ensure that one DMS left or right moves from the primary option on that MFD to the secondary option. Obviously if there are only two options on the MFD, there isn't a problem.

### 10.6. TFR In-Flight Check

Prior to initiating TFR flight, it is imperative to check the operation and integration of the TFR, radar altimeter, and digital flight control systems. This check is accomplished IAW the Dash 34 and in an area



of known elevation and relatively flat terrain. After a night takeoff, and the jet is cleaned up, don't forget to turn your HUD FLIR up so you aren't doing your checks into a black hole. The TFR check can be very task intensive depending on airspace limitations, currency, etc. Make sure you're mentally prepared. Do not continue TF operations until assured of correct system operation. The RATSIMPL cockpit check may be useful to complete the TF check and prepare for the next phase of flight.

- R - Radar altimeter - ON and operating after SWIM check
- A - ALLOW - 900' set
- T - TACAN - REC
- S - SCP - 1000' set
- I - IFF - as required
- M - Missile - COOL
- P - Pod - unstow TGP
- L - Laser arm - as required

### 10.7. En Route Cruise

If your mission includes air refueling or a medium altitude cruise segment prior to low level letdown, you may want to put the TFR in STBY or blended. Putting the TFR in STBY will allow you to fly formation without getting fly-ups and at slower airspeeds without the flashing limits symbology. Knowingly flying with flashing limits is a bad habit pattern to establish because it may desensitize you to the warning. The blended mode may also be useful. It is selected by turning the autopilot on with the TFR in any mode other than standby. If altitude hold is used blended will maintain the aircraft altitude while still giving you TF fly-up protection. Be aware that even if the AMS switch was in AUTO TF when you selected the autopilot function, the AMS will revert to MAN TF when you come out of blended by deselecting the autopilot. If you exit the blended mode by depressing the AMS switch, the autopilot will disengage and the system enters AUTO TF. AUTO TF combined with rough terrain or a little turbulence can be an excellent FOD generator. This is your last chance to arrange your cockpit prior to the ingress phase. Make sure you are strapped in tight and that maps, charts, and lineup cards are secured and in a useable order. Remember at night things will be harder to read. Consider writing bigger/darker and using different colors than you may be used to on day missions.

### 10.8. TFR Modes Of Operation

The TFR has six modes of operation from which you can choose: NORM, LPI, STBY, WX, ECCM, OR VLC. Choosing the appropriate mode varies from mission to mission based on the weather, terrain, and threat environment. Knowing the basics of each mode helps you choose the best mode for mission execution.

#### 10.8.1. NORM

This mode is usually planned for mission segments in all types of terrain, low threat, and good weather.

#### 10.8.2. LPI

Selected via the TFR page on the MFD or the run quiet switch and is usually used on longer/straight legs where minimum maneuvering is required and potential threats are present.

#### 10.8.3. STBY

Stows the TFR antenna and should be used on the ground and airborne only when TF fly-up protection is not required/desired.

#### 10.8.4. WX

The TFR processed data is reduced from 36,000' to 15,000' in front of the jet and the TFR look-up angle is reduced from 10° to 5°. You may notice a degraded capability to detect man-made objects and low reflective surfaces. You should select the WX mode if clouds and/or actual precipitation are along

your route of flight. This does not guarantee you won't get a weather fly-up, but it improves your chances for smooth sailing.

#### 10.8.5. ECCM

The TFR processed data is also reduced to 15,000'. This mode allows for operation in an ECM environment where numerous threats might be encountered. All other information is classified.

#### 10.8.6. VLC

Enter VLC by selecting 100' SCP on the TFR page. Initial commands will be to 200' until the terrain data criteria is met for 100' SCP. If the terrain does not continue to meet system requirements for 100', the SCP automatically bumps up to 200' and the jet climbs to 200'. A DMS forward anytime you are at 100' changes the SCP to 200' and climbs the jet. VLC is normally used in high threat, relatively flat terrain, where maneuvering is minimal.

### 10.9. Low Level Operations

#### 10.9.1. Prior to TFR Letdown

Before initiating an AUTO TFR letdown, review all your planned data including TOT adjustments, terrain elevation, route abort altitude, leg MSA, and minimum airspeed. Ensure all LANTIRN systems are on and functioning properly prior to beginning low level operations (ALOW set 90% of SCP, CARA ON, TFR out of STBY). Take the time necessary to ensure the systems are operating properly and that you are prepared for the transition to low altitude. Rushing this transition may lead to task saturation that may prove to be fatal. The RTFAM check may help remember major required tasks.

- R - Radar altimeter - ON
- T - TFR - appropriate operating mode
- F - FLIR - on HUD
- A - AMS - auto engage
- M - Monitor

#### 10.9.2. TFR Letdown

The initial TFR letdown should be meticulously monitored to ensure proper system operation. Things to watch include dive angle does not exceed 12° in an AUTO descent, the E2 scope has processed data displayed, the CARA is decreasing properly, and that the aircraft initiates level off for the SCP selected. Initially set the SCP to level off at 1000 feet. After initial level off and verifying proper system operation, reset the SCP as required for the mission.

#### 10.9.3. Tactical Navigation

You can help your situational awareness by doing systematic checks at each steerpoint. Setting your leg course in the CDI, setting the next heading with the Capt.'s bars, reviewing the update plan, checking gas, and clearing on the radar are some examples.

Given the limited FOV the FLIR gives you, it becomes even more imperative that the INS and system altitude be kept as tight as possible. Obviously, a GPS high/high status is a wonderful thing and can greatly reduce your cockpit workload. Without GPS high accuracy valid slews are normally entered into the system to improve the KALMAN operation.

Due to changing conditions, you will probably also need to adjust FLIR gain, brightness, and contrast along the route. The TDA may help anticipate areas where higher gain may be required. The bottom line is to adjust the picture to make it work best for you. Auto gain is always an option.

As you become more comfortable and proficient, you must guard against complacency when using the TFR LANTIRN system. Maintain the cross-check that you established in the day VFR low altitude situation workload of cockpit data and rocks. When your GPS isn't working and you must do manual fixes and ACALs, pacing and prioritization become critical. Knowing where, when, and how to do a fix is essential. Try to minimize your time in the FIX modes so you can maximize your air-to-air radar search time. For FCR modes, use the GM cursor for 6/12 slews and if the point can be brought near the

HUD center, use the HUD diamond/offset aimpoint symbol for 3/9 slews. One technique for visual modes is to start a slight climb to aid in turnpoint identification and increase AGR slant ranges for better accuracy. In any case, don't enter the FIX/ACAL update until you have checked your deltas and are satisfied with the correction.

#### 10.9.4. Terrain Masking

Thorough route study prior to flight is imperative. Knowing where high/rough terrain is will allow you to follow the path of least resistance to optimize terrain masking. Use a combination of the FLIR and flight path marker to help you terrain mask. In mountainous terrain, look long-range in the FLIR for saddles in hills or the path of least resistance. Point the jet via the flight path marker, and use look-into-turn and snap-look to aid your decision.

#### 10.9.5. Fly-Ups

Should a fly-up indication occur, roll to wings level and allow the system to increase pitch until reaching a 20° climb. If the system resets before reaching 20°, you may allow it to descend while verifying normal operation. At 20°, depress and release the paddle switch. If this resets the system, verify normal operation and descend back to low altitude. If the paddle switch did not reset the system, hold the paddle switch and level above the MSA/RAA. If the malfunction can not be cleared, TFR operations can not be continued. Cease low level operations and continue at the MSA. Once established at the MSA, determine whether or not to continue with the mission or RTB. The word displayed in the HUD should be referenced as it is the only exact indication available of why the fly-up occurred.

### 10.10. Threat Reaction

At night, weapons explosions and secondaries from AAA and SAM launches can be very disorienting. Having a solid cross-check and threat reaction game plan is essential. The aggressive maneuvers normally associated with threat reactions can be very disorienting at night. The maneuvers must be performed using aircraft references unless the horizon is clearly visible without reference to the FLIR. It may be more important to maintain orientation than to defeat a threat that may not be targeting you. Since you cannot easily monitor other aircraft in the formation during a threat reaction, it is important that reacting pilots communicate information such as reference headings, altitudes, and type of reactions to other flight members when initiating a threat reaction. During all threat reactions, dispense chaff and/or flares as required and use ECM as required to degrade radar or missile capability.

#### 10.10.1. Medium Altitude Threat Reaction Considerations

Use FCR, TACAN range and HUD FLIR to maintain formation position. Additionally, you can use altitude separation to deconflict from other flight members who are executing a threat reaction. Since you are above the MSA at medium altitude, you can maneuver freely outside of TF limits and use altitude to help maintain energy to defeat the threat. If individual flight members threat react, they can flow to the back of the formation following the reaction. You may want to consider keeping elements together during a threat reaction to help spot follow-on threats and monitor altitude for the reacting aircraft. As a technique, you can set in a minimum altitude in your MSL floor warning to alert you to the MSA. If you plan on descending below the MSA during the threat reaction, ensure your TFR is operating and you remain in limits.

#### 10.10.2. Low Altitude Threat Reaction Considerations

Station keeping consideration are identical to the medium altitude considerations. There are several options for low altitude threat reactions commencing below the MSA. The first option may be simply to select a lower SCP and check away from the threat. Use direct and indirect terrain masking to help deny acquisition. The second option is initially a climb to or above the MSA followed by maneuvering as required. This option can be used in cases where you have sufficient time after your initial threat indication to execute the climb and reaction prior to engagement. The final option is a 30-45° bank oblique turn from below the MSA to an altitude at or above the MSA. If you pull more than approximately 2.5 G in a left turn or 1.7 G in a right turn you will exceed TF limits. Once reaching the MSA, over bank to approximately 90-120° of bank and pull as required to the new heading. While in a low altitude notch maneuver, a technique to dispense chaff with G on the jet is to momentarily pull up to

5-10° nose high with 3-4 Gs while simultaneously dispensing chaff. Release the stick immediately after dispensing chaff and the auto TFR will bring you back down with minimal exposure. This technique is sometimes referred to as a “porpoise”.

### 10.11. Low Altitude LANTIRN Attack Options

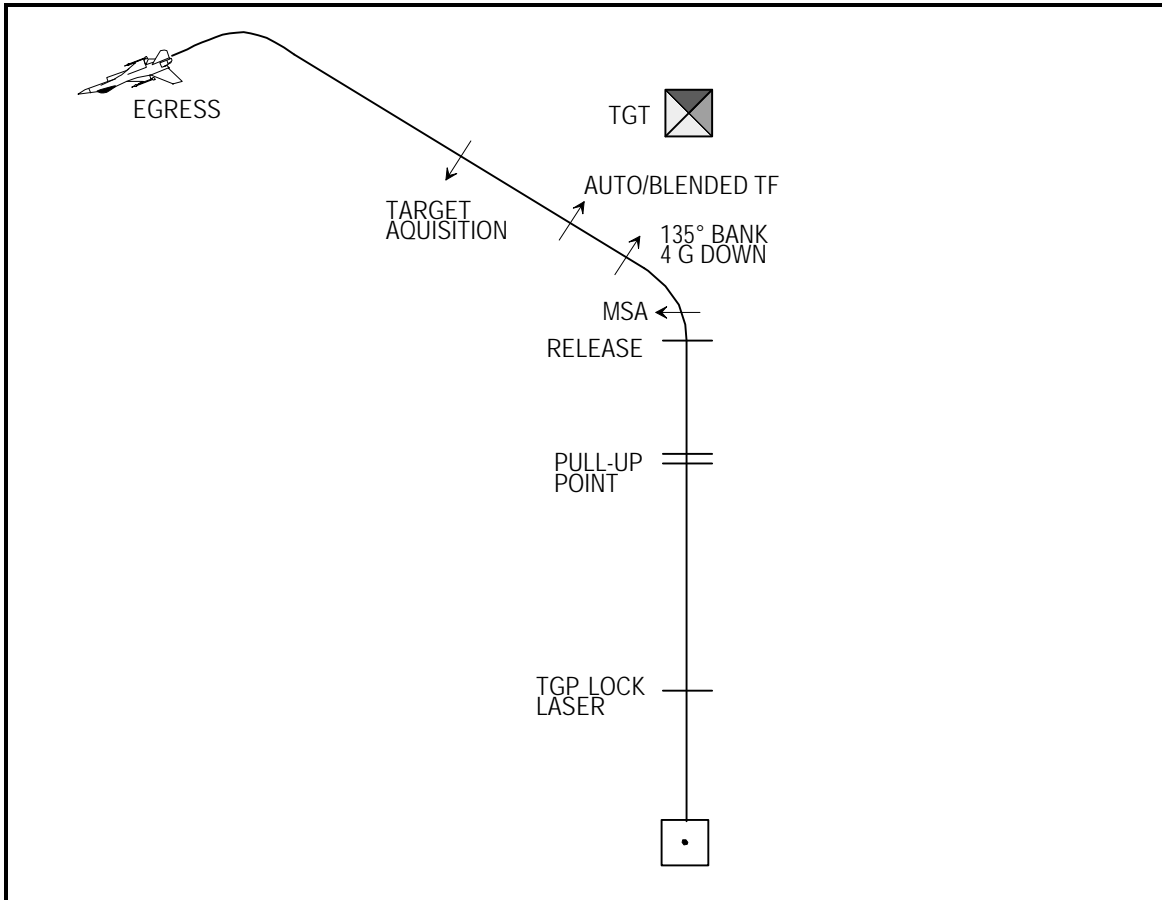
The TGP provides an excellent capability for the delivery of both guided and unguided munitions. TGP passive and laser ranging combined with an accurate navigational position and system altitude, provide a significant improvement in weapons delivery accuracy for unguided munitions.

GM radar and visual slews can be used as a verification of GPS accuracy or as a backup for cases when GPS or coordinate accuracy are uncertain. Extensive knowledge of what you expect the target to look like and using all available sensors will help to defeat the enemy’s camouflage, concealment, and deception techniques. If GPS is not available or GPS ACAL is not used, an ACAL should be accomplished in the target area. Ideally, a pre-IP should be used to update the system and provide attack axis alignment. If the TGP can be slewed to the IP, RP, or an OAP, your steering to the target will be updated. Laser ranging can be used to update height above target. You can also use the pop dot as a head-up reference for your pull-up or action point. Airspeed is a critical factor during climbing maneuvers. Ensure you accelerate as planned or you may not be able to execute the attack.

#### 10.11.1. TGP/LGB Loft

The loft delivery with the TGP/LGB combination (Figure 10.2) provides both target stand-off and precise guided weapons delivery. Ideally, the LGB should be lofted upon mensurated coordinates with nothing but GPS to aim the system. Without GPS, a precise update on an accurate IP should be performed; and nothing more until after the LGB has been lofted. The problem is that at low graze angles and long distances, there is little Delta T for the TGP to AREA track. AREA tracking the DMPI prior to release will therefore result in a wandering TGP. Furthermore, the AREA track crosshairs can’t be accurately placed over the DMPI from low graze angles and long distances. Attempting to do so will impart an erroneous 2-3 mil error which will become significant during the guidance segment of the loft. If a DMPI has enough vertical development and Delta T, then it can be POINT tracked during the IP to target run without any problems, until the loft pull-down when it will revert to RATES and impart an unwanted slew. Regardless of track mode, lasing the DMPI from low graze angles and long distances will always impart an incorrect range to the system as it is too easy for the laser to miss the top of the DMPI by one mil and range-in several thousand meters long. The only acceptable answer is to POINT track the DMPI—without lasing it—and break lock prior to release. There are several combinations of TFR modes that can be used to loft an LGB. The old method is to use MAN TFR for the run-in, pull-up, and recovery. This requires 100% of you attention be devoted to the FPM and MAN TFR box. Another method is to remain in AUTO TFR throughout the loft maneuver. As long as you roll to beyond TFR global limits in less than two seconds, no fly-ups will result. This technique is good because you remain within AUTO TFR protection for a longer period of time. however, during the pull-up you will be fighting the AUTO TFR which is constantly attempting to pull you back down to the selected SCP. Furthermore, the ATUO TFR will descend you 12° nose low during the LGB guidance segment, unless you manually hold the nose up. Another technique is to use altitude hold blended mode for the LGB guidance segment of the loft. This is good in case of terrain or podium effect problems, but makes you more vulnerable since you do not descend to low altitude quickly. A final technique is to engage attitude hold blended mode when inside the IP, level at the SCP. Remain in blended throughout the loft maneuver; this will resemble AUTO TFR in the HUD and provide AUTO TFR protection. No back pressure will impede the pull up as you are not in AUTO TFR. No fly-ups will occur as long as you roll to beyond TFR global limits within 2 seconds. The LGB should be lofted at an angle between 30°-35° nose high. Either the programmed loft angle and HUD climb cues can be referenced, or the constantly computed loft angle displayed next to the altitude scale in the HUD can be referenced. After LGB release, always reference the TGT MSA prior to rolling to 135° of bank and pulling down—not across the horizon—with 4 G to 5° nose low. Roll out wings level at 5° nose low and keep your attention in the HUD until you see the ATTITUDE HOLD blended TFR line below the FPM. A SWIM fly-up is not uncommon at this point if the RALT times in prior to the TFR. If this happens, paddle and release very quickly. To adjust the descent angle, simply place the FPM where you want it. Paddling to adjust the attitude-hold

descent angle is not required. You will now have a 5° nose low descent for LGB guidance—much improved line of sight to the DMPI—without diverting any attention or effort to manually holding back stick pressure. Once the attitude hold blended TFR line is visible beneath the FPM, without any switch changes, you can devote your attention to the TGP display to acquire and track your DMPI. If you see the indications of masking, then you can simultaneously bank away from the target (5° of bank or less) and depress the AMS to descend at 12° nose low. You should be tracking the DMPI prior to laser start time. Minimize slews when the laser is firing and the LGB guiding. however, if the TGP wanders off the DMPI, put it back on. If you are still descending at 5°, once the LGB detonates you can engage the AMS and have the AUTO TFR bring you down more quickly to the low level structure. At this point there is sufficient attention and time available for you to devote to flying precise egress headings and regaining FLIR visual with your leader.



**Figure 10.2 TGP/LGB Loft**

#### 10.11.1.1. TGP Masking Considerations

Since the TGP is mounted on the right chin station, left turning egresses reduce the risk of a mask prior to weapon impact. Right turning egresses are possible, however they are less tolerant of poorly executed escape maneuvers. If the situation permits, delay your descent to low altitude until weapon impact to help maintain line of sight to the target. Blended attitude or altitude hold may reduce task loading in this situation.

#### 10.11.2. TGP/LDGP Loft Or Fly-Up Attacks

If delivering unguided conventional weapons the TGP provides an excellent target identification and update capability. Loft execution through weapons release is identical to the LGB delivery. Since the weapons are unguided, there is no requirement to track and lase the target after release. Since a TGP lock is not required, you can also increase the G in your escape maneuver to 5 G. The important thing to stress

here, however, is to not do any head down tasks prior to being in AUTO TF. If the target is visually acquired on a TGP assisted fly-up or direct attack and CCIP is selected, the TGP will break track and follow the pipper.

### 10.11.3. TGP/LGB Fly-Up Attack

If threats and the situation dictate, you can execute a fly-up attack to a level LGB delivery above weapon frag envelope. The fly up allows a better view angle to the target and much easier target identification. Commence the fly up at a range and angle that will allow enough time for TGP track and range update prior to release. Execute the egress the same as in a loft delivery. (Figure 10.3.)

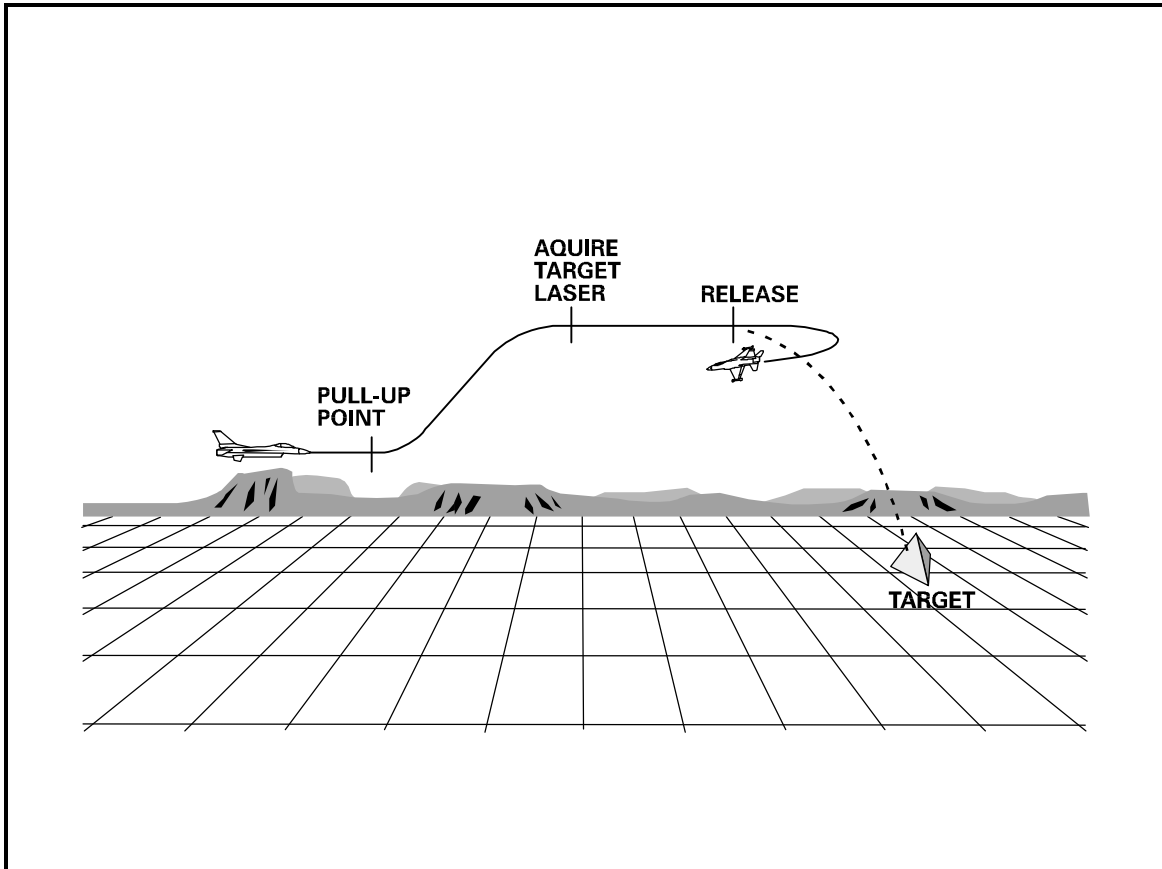
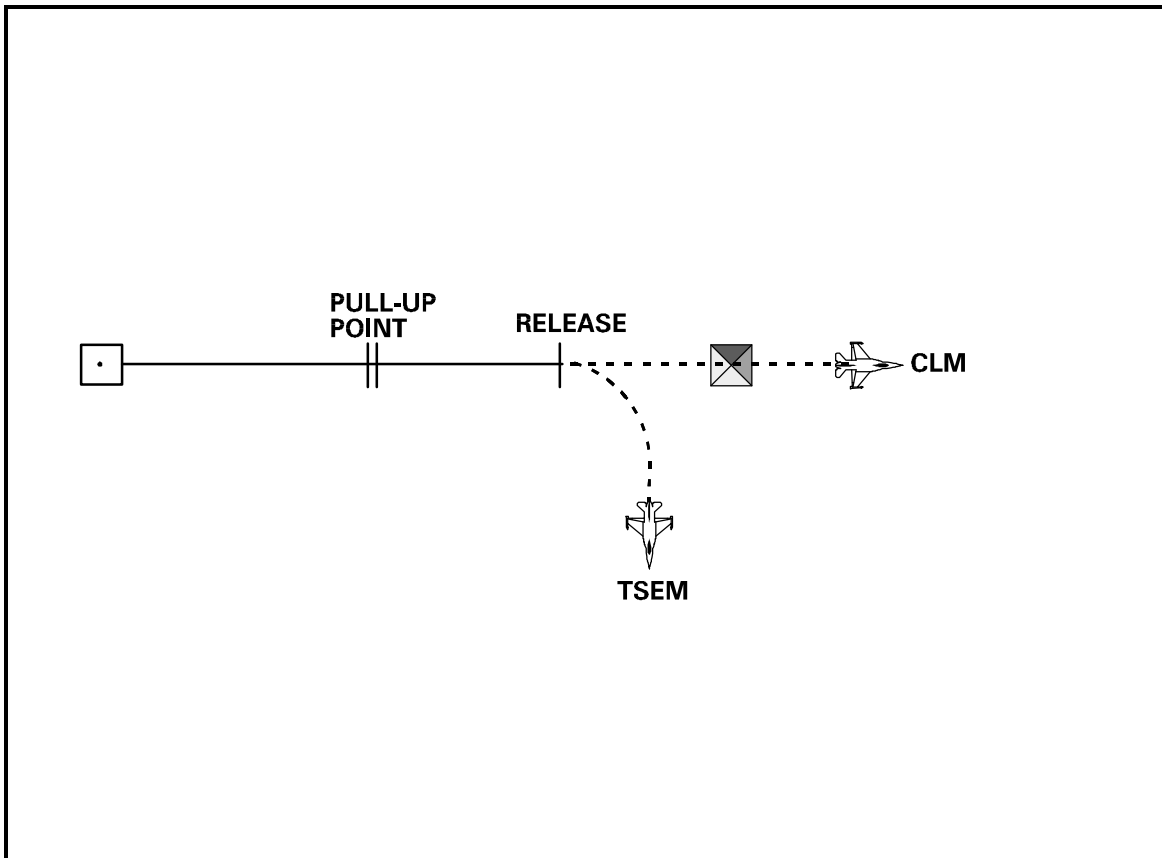


Figure 10.3 TGP/LGB Fly-Up Attack



**Figure 10.4 NVP Direct attack**

#### 10.11.4. NVP Direct Attack

The direct pop provides an attack option for cases where stand-off deliveries are impossible or not desired (i.e. TGP failure, non-PGM, weather) (Figure 10.4). Select AG/CCRP and use the TGP/FCR/HUD FLIR to acquire the target. When conditions prevent target acquisition, rely on INS/GPS (break lock and cursor zero TGP/FCR) approximately 2 NM from action point and concentrate on the direct attack (HUD). Select MAN TF approximately 2 NM from your pull-up point. At the pull-up point, establish desired climb angle using the HUD flight path marker. There are two options for establishing your desired dive angle after reaching pull-down altitude. The first option is a 180° roll and pull. At planned pull-down altitude, roll the aircraft 180° and pull straight down with 3 G. Do not attempt to correct steering inverted. At 5° prior to the desired dive angle, reduce G and roll upright. Roll out in the same direction as the initial roll-in to minimize offset from the steering line. Adjust dive angle and the bomb fall line as required. A SWIM fly-up may occur during this maneuver since the RALT may be slow to reacquire the ground prior to establishing TF limits. Another option is to perform a bunt at the pull-down altitude. For this attack you can remain in AUTO TF the entire time. At the push-down altitude the AUTO TFR will perform a perfect .2 G bunt if you just let go of the stick. Since the G during this maneuver is lower the pull-up point is farther from the target. Use caution when correcting for steering errors during the bunt. If you use negative G during the bunt, your lift vector is out the bottom of the aircraft. To correct towards the vertical steering line, bank AWAY from the line during the bunt. If this is too confusing, wait until after establishing AOD and make normal steering corrections. Abort the pass if parameters are not met. If you acquire the target, you can select CCIP for weapon release. Select CCIP at least 3-4 seconds prior to desired release to avoid having an unusable piper as it does its initial air-to-ground ranging. Remember that AGR, system, and FLIR boresight errors will affect your bombing accuracy with CCIP. If the target is not apparent in the HUD, you may deliver ordnance in CCRP (bomb the TD box).

#### 10.11.5. Level Delivery

A level delivery provides a capability for high drag weapons employment when target acquisition may be limited, the pull-up point was missed or could not be identified, or with systems failures such as a HUD failure. Approaching the target, climb above computed MRA. Do this by either; remaining in AUTO and selecting a higher SCP, by pulling up and selecting blended TF, or by selecting MAN TF and climbing. Since MAN TF requires more concentration it is not recommended. If you can, acquire the target with the FCR or the TGP prior to release to use radar or laser ranging to update your weapons release solution. Without accurate HUD FLIR aiming, the best delivery option is a CCRP level. If you can only acquire the target in the HUD FLIR, use a CCIP delivery.

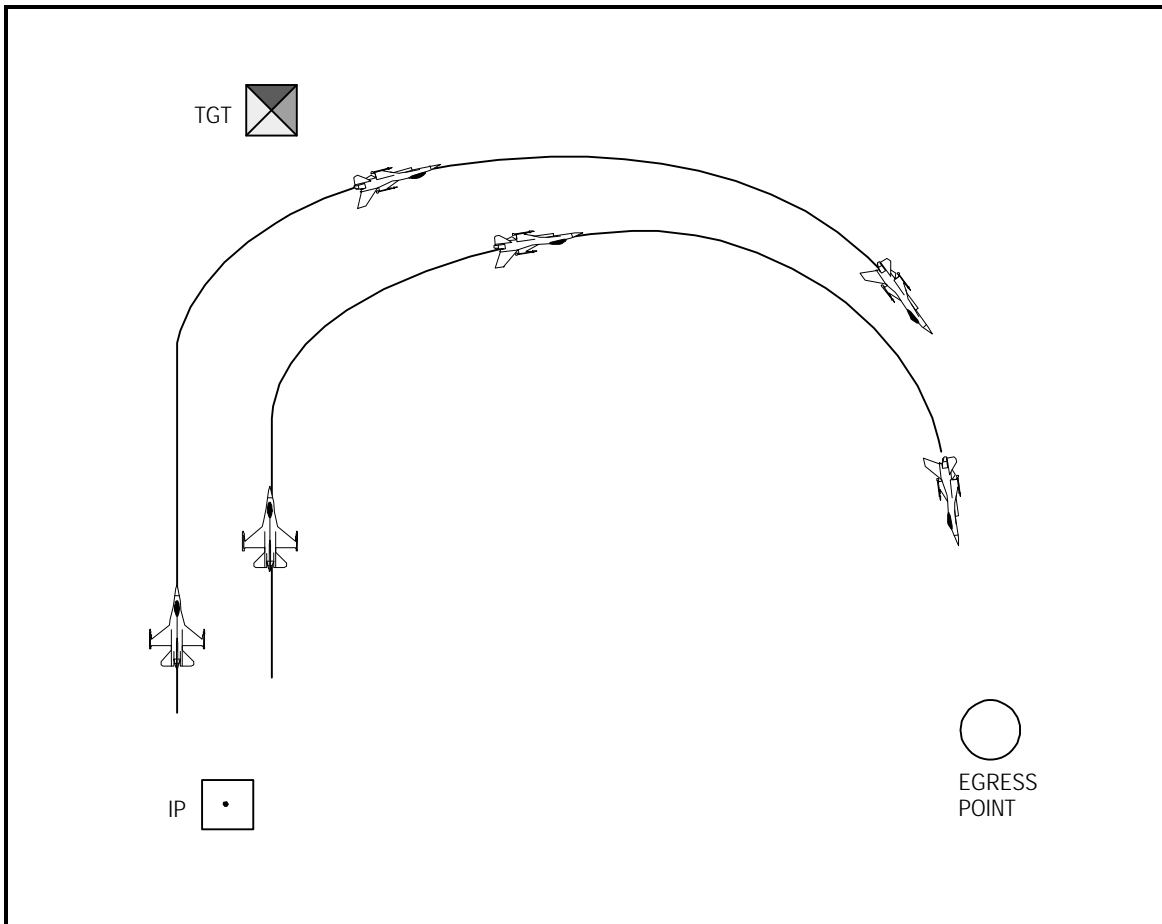
#### 10.11.6. Maverick Attacks

The TGP simplifies low level Maverick employment and allows multiple shots per pass. Even without a TGP, the Block 40 F-16 has the capability to lock two Mavericks to separate targets prior to release and provides missile slaving through either HUD slews tied to a TD box or FCR slews tied to the GM/GMT radar cursors. Based on the forecast detection range, bump up for LOS to the target. Do this like the level delivery mentioned above. MAN TF may be selected just prior to launch. Use the FCR/TGP to identify your target. If using the TGP, simply point track the target with the TGP to commence the missile hand-off. If the Maverick has not correlated, TMS right to reattempt hand-off. Use the WPN MFD page to verify correct Maverick hand-off. Cross check range to the target prior to handing off a second missile. Once both Mavericks are locked, shoot each missile individually. Verify weapon track on the WPN page between shots. Since it is required that the pilot select the weapon as the SOI and adjust polarity prior to track without the TGP, it demands more time and may prevent a multiple launch opportunity. After launch, based on range to the target, either execute an in TF limits turn or climb to or above MSA and execute a 4-5 G escape maneuver to the initial egress heading.

#### 10.12. Escape Maneuvers

At night, treat the escape maneuver like an instrument maneuver. Concentrate on HUD and instrument references, especially bank and climb angle. The preferred escape maneuver from a diving delivery is the turning maneuver (level turn). After releasing the weapons, execute a 5 G pull to the horizon to an altitude at or above the MSA, then execute a 5 G level to slightly climbing turn through a minimum of 60° heading change. If recovery altitude is below the MSA, then either adjust release altitude to recover at or above the MSA or execute a climbing safe escape maneuver (CLM). The CLM is less desirable since you will complete the maneuver 30° nose high, at a higher altitude with low airspeed. However terrain or weapons release may force you into a situation where the CLM is required. Escape and egress maneuvers should be well understood, solidly briefed, and precisely flown in accordance with your squadron standards. There should be no confusion over release altitudes, climb angles, power settings, level-off altitudes and egress heading so that wingmen can successfully fly through lead's smoke trail and reestablish a FLIR visual without the help of lead's strobe light (as in a combat environment) (Figure 10.5).





**Figure 10.5 Egress Formation Flow**

#### 10.12.1. Multiple Attacks

Multiple attacks can easily lead to task saturation and loss of SA. Adherence to formation responsibilities and radio calls are required to prevent conflicts.

An extremely important consideration when doing multiple attacks is for all pilots in the flight to fly the pattern as briefed. Use the same techniques for station keeping as performed on the ingress. The hazards of day surface attack missions still apply but are more prevalent at night. The "coffin corner" can be a real threat if your leader flies a 90/90 pattern and you fly a 120/60 pattern from the base turnpoint or anyone cuts an egress short.

### 10.13. Medium Altitude Ingress And FLIR Attacks

#### 10.13.1. FLIR Tuning For High/Medium Altitudes

FLIR tuning at high altitudes is still dependent on humidity, surface winds, and other IR factors. However, a perfect FLIR picture at 30,000 feet is not as critical as the one at your track and release altitudes. A release at 10,000 feet AGL is about two miles slant range on the FLIR. Add in tracking slant range and your best FLIR picture needs to be around two to three miles. Don't get caught trying to identify enemy tanks with the same FLIR gain setting used at high altitudes to see mountains 20 miles away. If you can FLIR tune at night on an object 2-3 miles away remember the gain setting and use it for your night dive attack.

#### 10.13.2. Airborne FLIR Boresight

FLIR boresight is critical for any kind of night CCIP deliveries. If in night FLIR trail, check your ground boresight accuracy by seeing if lead's "FLIR dot" is just below his strobe. Superimpose the two

images by selecting BSGT on the FLIR MFD, and slew the FLIR image to the aircraft strobe. Best results are achieved at planned bomb range directly behind lead in a non-maneuvering environment. Lead can sometimes use the same technique on the tanker.

#### 10.13.3. **Flight Planning**

Along with threat rings other planning factors such as mandatory ingress/egress points and wind speed and direction are critical for medium altitude FLIR bombing. Try to plan your IP-TGT run directly with or against a strong wind. If the FCC believes the bombs will hit more than 1500 feet left or right of target, it will prevent release. Even in CCIP, the bombs will not come off if you do not follow steering with a delay cue. Only a few degrees off steering is needed to inhibit release of CBU-87 released at 15,000 feet with a 100 knot crosswind. If GPS is not working, the radar is your primary tool to update your INS. Unlike low altitude LANTIRN flights, avoid using small mountains or peaks as navigation points because they will not show up well on the radar. The best update points are cultural returns such as river junctions or bends, bridges, coastline peninsulas and piers which will paint well in ground map radar.

#### 10.13.4. **Altitudes And Airspeeds**

Ingress altitudes depend on weather, aircraft ordnance, engine type (GE vs PW), targeting pod laser ceiling, and many other factors. Ingress above 25,000 feet puts you above almost all AAA and many SAM envelopes. At these altitudes, airspeeds need to be kept above 300 KCAS to help defeat medium to high SAM threats. Fuel consumption is not bad at high altitudes even in mil power. A block 40 GE F-16 with 4 CBU-87 can cruise just below Vmil at 310 KCAS at 30,000 feet. With 2 MK-84's it can easily go 330 KCAS or almost Mach 1.

#### 10.13.5. **Formation**

The most important consideration when flying FLIR trail is to never place lead's FLIR image near your FPM. There is no depth perception through the FLIR and high closure rates can develop quickly. Place lead's FLIR image outside either the altitude or airspeed scales in the HUD field of view. With the FCR decluttered, it is easy to monitor lead's range with simple radar returns. On a 40 nm scope, flying 1-2 nm trail, lead's returns will fall between the bottom edge of the MFD and the bottom of the azimuth tick marks. Now, the wingman can sanitize with his 40 nm FCR scope and still maintain 1-2 nm FLIR trail. Air-to-air TACAN is another valuable tool.

If maintaining FLIR trail for an extended period of time, the FLIR polarity may have to be changed to maintain a visual with lead's FLIR image against changing backgrounds. When flying FLIR trail for extended periods of time, periodic FLIR boresights and tunings are a good idea. For these reasons, some pilots suggest maintaining FLIR as a selectable option on the left MFD.

One of the most difficult problems with night flying is doing it with other blacked-out aircraft. FLIR trail complexity increases dramatically the more aircraft you drag along. Avoid radar trails and use "buddy-locks" only if you don't trust your FLIR and A/A TACAN to give you formation SA. Responsibilities for lead are to inform the rest of the flight of any deviations to briefed airspeeds, altitudes, or headings. Two should keep lead's FLIR dot in the HUD FOV and use A/A TACAN to maintain 1-2 NM trail. Three should keep two's FLIR dot in the HUD FOV and periodically cross-check 1-2 NM trail using A/A TACAN X/Y feature. Four's job is the same as two.

<u>Lead</u>	<u>Two</u>	<u>Three</u>	<u>Four</u>
29X	92X	29Y/X	92Y
	1 NM	1 NM	1 NM

Adding additional four-ships to increase packages to 8 to 12 jets has been combat tested with some controversial success. Using 2-3 NM spacing between four-ships helps reduce pilot workload for number five and/or nine since they cannot depend on A/A TACAN for spacing. Distance between jets is important. If you are less than 1 NM you spend too much time worrying about hitting lead and not enough time in the radar or targeting pod. More than 2 NM spacing spreads the formation to a point where lead's bombs are hitting when two is "down the chute", thus eliminating surprise and getting two shot at. Altitude stacks can be used for deconfliction if desired.

#### 10.13.6. IP To Target Considerations

Wind speed/direction and ordnance drag greatly effect action and roll-in distances. Use TGP/FCR to help you find targets. Roll-in or push-over ranges depend on ordnance drag, planned dive angle, altitude, and winds. If you are using GMTT to drop on a mover, consider breaking lock and dropping a CCRP bomb. Following GMTT steering to bomb release is sometimes difficult since the GMT radar lock has trouble with the look-down angle and the steering line sometimes jumps erratically inside of 4 NM. Remember, however, that GMT use will lead a moving target whereas GM and CCIP will not.

#### 10.13.7. Parameters

If bunting on CCRP steering from medium altitude, do not get laser ranging with the trigger. You will get a bomb release at dangerously low Gs and collision with your released munitions is almost inevitable. With radar fuzes or iron bombs, do not sacrifice target ID or putting the piper on the target by trying to fly perfect parameters. Above 4500 feet AGL most bombs will easily have time to fuze arm and you are well above frag altitudes. The most important thing is to follow CCRP steering or put the piper on the target. After pickle in CCIP, remember to follow steering perfectly until bomb release if there is a delay cue. Release of canister munitions above 10,000' will almost always involve a delay cue. Avoid pickling and pulling 5 G's above level flight or you will be lofting CBU above 10,000 feet. Best FCC computations occur if you pull to level flight and have bomb release at one G. Avoid speeds above 0.95 Mach since airflow may be supersonic over the ordnance and change ballistics. This will usually happen if you leave the power at mil on roll-in. Remember, even with a perfect jet, perfect FLIR boresight, and the piper on the target, releases at high altitudes sometimes miss due to the actual winds not matching the FCC wind algorithm, especially with ordnance like CBU-87.

#### 10.13.8. Medium Altitude TGP Employment Considerations

The TGP provides improved ranging information, target identification, and precision guided munitions capability from medium altitude. When delivering LGBs from medium altitude, a level delivery is the easiest to execute. After weapons delivery, turn between 30-90° away from the attack axis. This prevents the TGP video from inverting as you pass over the target. Monitor time to impact and adjust aiming as required prior to weapon impact. After weapon impact, continue your turn to the final egress heading.

Maverick employment from medium altitude is simplified with the TGP. Use the TGP to hand-off two Mavericks if required. Monitor the aiming cross on the Maverick WPN page since it is easy to gimbal the Maverick seeker head from medium altitude. If the pointing cross is flashing due to gimbal, bunt the aircraft to center up the cross prior to weapons release. After launching, you can execute a more aggressive maneuver to the egress heading since end game designation is not required.

The TGP can also provide a precise aiming and ranging capability for dropping unguided weapons. Use passive ranging and the laser to update range to the target. Release the weapons in CCRP. Use caution for any delay cues, especially with canister munitions such as CBU or Rockeye. If required, you can establish a dive toward the target area if FLIR visibility is poor or you desire a lower release altitude for weapons effects.

#### 10.13.9. Egress

It is important for a wingman to be able to fly through lead's smoke trail during the egress in order to regain a FLIR visual with lead after a diving delivery. This is especially true for combat operations without a strobe lights illuminated.

A well briefed, thoroughly understood, and precisely executed "squadron standard" egress maneuver is critical for a wingman to fly through lead's smoke trail. Furthermore, depending on threats, but independent of delay cues, the egress maneuver should start from the planned release altitude. Safety is also a concern if a wingman were to pull through a delay cue 2000' high while the flight lead drove down to release altitude.

There should be no confusion during the egress about release altitudes; climb angles, headings, power settings, airspeeds; or level off altitudes, headings, airspeeds. After the last aircraft departs the target area safely, use radial DME off of the egress point to gain formation SA.

## **10.14. The Return To Base (RTB) Phase**

### **10.14.1. Night Rejoin**

Like any surface attack mission, night LANTIRN missions are very similar when it comes to the rejoin and RTB. There are numerous techniques when it comes to rejoining the flight. The two most common techniques are to rejoin the flight into elements or rejoin the flight into the formation you used for the ingress. Your local directives/radar facilities/ATC procedures most likely dictate whether or not you rejoin into close formation. It might not make sense to rejoin into close formation for a 60 NM RTB if you've been flying in 8 mile trail all night, only to split up near the field for individual approaches. On the other hand, if you will be doing ASLAR recoveries due to a high traffic count and it helps ATC to be an element, then rejoining might be your only option. If you decide to rejoin, then you should use the procedures outlined in Chapter 5. Don't forget to select TFR to STBY to avoid a fly-up command from the lead aircraft. An additional technique is for all flight members to continue flying the bombing pattern until the last fighter comes off target. This allows him to have good situational awareness on the other flight members. You can use your radar in an A/A mode to assist in identifying your leader and keeping track of the others. From this point, you can either rejoin into elements or as a four-ship, or you can maintain your current position all the way home.

### **10.14.2. FLIR Use During Recovery**

Since you have a NVP and may have a TGP pod on board, you have the option of using the FLIR displays to assist during the RTB. You can use the FLIR display in the HUD to give you another horizon reference (assuming you're not in weather), which will simplify your cross-check. It also is an excellent way to keep track of where the cloud decks or cells are. Be careful not to turn the intensity too high or you won't be able to see the normal HUD symbology and FLIR symbology. Additionally, if the FLIR is turned up too high, it could cause a green reflection on the canopy which may affect your night vision. The TGP may also be used to detect weather, but be careful not to get distracted. If you're a wingman rejoining on another aircraft, you should be concentrating on flying a good rejoin and not looking in the TGP display for weather.

### **10.14.3. Approach And Landing**

If necessary to use the FLIR for approach and landing, turn the HUD FLIR down or off as normal visual cues appear. Leaving the FLIR on during the flare could result in high flare and dropped in landing. As a technique, start the flare about the time the landing light illuminates the runway, but focus on the end of the runway to better detect and control sink rate.

## **10.15. Radio Calls**

Although radio calls at night are essentially the same on the range as they are during the day, they take on an even greater importance because of reduced visual cues. It is extremely difficult to judge distances based solely aircraft lights or FLIR, so the air-to-air mode of the radar becomes invaluable. It must be stressed, however, that in the event you don't know where everyone in the flight is, ask. Additionally, make sure you transmit the required calls at the briefed point. They are situational awareness builders for everyone.

## Attachment One

## ABBREVIATIONS, ACRONYMS, AND SYMBOLS

<b>AA</b> .....	aspect angle	<b>ASAP</b> .....	as soon as possible
<b>A-A</b> .....	air-to-air (master mode or TACAN)	<b>ASOC</b> .....	air support operations center
<b>AAA</b> .....	anti-aircraft artillery	<b>ATA</b> .....	antenna train angle
<b>AAM</b> .....	air-to-air missile	<b>ATC</b> .....	air traffic control
<b>AB</b> .....	afterburner	<b>ATO</b> .....	air tasking order
<b>ACAL</b> .....	altitude calibration	<b>ATT</b> .....	attitude
<b>ABCCC</b> .....	airborne battlefield command and control center	<b>AUTO</b> .....	automatic
<b>ACM</b> .....	air combat maneuvering or air combat mode (radar mode)	<b>AWACS</b> .....	airborne warning and control system
<b>AD</b> .....	arming delay	<b>AZ</b> .....	azimuth
<b>ADC</b> .....	air data converter	<b>BA</b> .....	burst altitude
<b>ADI</b> .....	attitude director indicator	<b>BARO</b> .....	barometric
<b>AFAC</b> .....	airborne forward air controller	<b>BATR</b> .....	bullets at target range
<b>AFTO</b> .....	Air Force Technical Order	<b>BCN</b> .....	beacon mnemonic
<b>AG</b> .....	air-to-ground switch position	<b>BDA</b> .....	battle damage assessment
<b>A-G</b> .....	air-to-ground (master mode)	<b>BDU</b> .....	bomb dummy unit
<b>AGL</b> .....	above ground level	<b>BFL</b> .....	bomb fall line
<b>AGM</b> .....	air-to-ground missile	<b>BFM</b> .....	basic fighter maneuver
<b>AGR</b> .....	air-to-ground ranging	<b>BL</b> .....	bomb live
<b>AHC</b> .....	aircraft handling characteristics	<b>BLK</b> .....	block
<b>AI</b> .....	air interdiction	<b>BLU</b> .....	bomb live unit
<b>AIM</b> .....	air intercept missile (e.g., AIM-9L/M)	<b>BORE</b> .....	boresight
<b>ALB</b> .....	air land battle	<b>BP</b> .....	bypass
<b>ALO</b> .....	altitude low mnemonic	<b>BR</b> .....	bomb range
<b>ALOW</b> .....	automatic altitude low warning	<b>BSU</b> .....	bomb stabilizing unit
<b>ALT</b> .....	altitude	<b>BUC</b> .....	backup fuel control
<b>AMRAAM</b> .....	advanced medium range air-to-air missile	<b>BVR</b> .....	beyond visual range
<b>AOA</b> .....	angle of attack	<b>C3I</b> .....	command, control, communications, and intelligence
<b>AOD</b> .....	aim-off distance	<b>CADC</b> .....	central air data computer
<b>APC</b> .....	armored personnel carrier	<b>CARA</b> .....	combined altitude radar altimeter
<b>API</b> .....	armor piercing incendiary	<b>CAS</b> .....	close air support or calibrated airspeed
<b>AR</b> .....	action range	<b>CAT</b> .....	category
<b>ARCT</b> .....	air refueling contact time	<b>CATA</b> .....	collision antenna train angle
		<b>CBU</b> .....	cluster bomb unit
		<b>CCD</b> .....	camouflage, concealment, and deception

<b>CCIL</b> .....	continuously computed impact line	<b>EPU</b> .....	emergency power unit
<b>CCIP</b> .....	continuously computed impact point	<b>EU</b> .....	electronic unit
<b>CCRP</b> .....	continuously computed release point	<b>FAC</b> .....	forward air controller
<b>CENTAF</b> .....	Central Air Forces	<b>FCC</b> .....	fire control computer
<b>CENTCOM</b> .....	Central Command	<b>FCNP</b> .....	fire control navigation panel
<b>CEP</b> .....	circular error probable	<b>FCR</b> .....	fire control radar
<b>CLM</b> .....	climbing safe escape maneuver	<b>FEBA</b> .....	forward edge of the battle area
<b>COMSEC</b> .....	communications security	<b>FEDS</b> .....	firing evaluation display system
<b>cos</b> .....	cosine	<b>FL</b> .....	flight level
<b>CRC</b> .....	control and reporting center	<b>FLCS</b> .....	flight control system
<b>C.S.</b> .....	call sign	<b>FLIR</b> .....	forward looking infrared
<b>CSAR</b> .....	combat search and rescue	<b>FM</b> .....	frequency modulation
<b>CTVS</b> .....	cockpit television sensor	<b>FMU</b> .....	field maintenance unit
<b>CZ</b> .....	cursor zero	<b>FO</b> .....	flame out
<b>DB</b> .....	dive bomb	<b>FOV</b> .....	field of view
<b>DBS</b> .....	doppler beam sharpening	<b>FPM</b> .....	flight path marker/feet per minute
<b>DED</b> .....	data entry display	<b>FPS/fps</b> .....	feet per second
<b>DEG</b> .....	degree	<b>FRAG</b> .....	fragmentation
<b>DEST</b> .....	destination	<b>FRL</b> .....	fuselage reference line
<b>DGFT</b> .....	dogfight (master mode)	<b>FSCL</b> .....	fire support coordination line
<b>DIR</b> .....	direct aim	<b>FTIT</b> .....	fan turbine inlet temperature
<b>DME</b> .....	distance measuring equipment	<b>FTT</b> .....	fixed target track
<b>DMPI</b> .....	desired munitions point of impact	<b>FWD</b> .....	forward
<b>DNIF</b> .....	duty not involving flying	<b>FZ</b> .....	freeze
<b>DR</b> .....	dead reckoning	<b>g</b> .....	in math formula ( $32'/\text{sec}^2$ )
<b>DTC</b> .....	data transfer cartridge	<b>G</b> .....	total G on aircraft/pilot
<b>DTOS</b> .....	dive toss	<b>GBU</b> .....	guided bomb unit
<b>E<sub>s</sub></b> .....	specific energy	<b>GCI</b> .....	ground controlled intercept
<b>ECM</b> .....	electronic countermeasures	<b>GE</b> .....	General Electric
<b>ECS</b> .....	environmental control system	<b>GFI</b> .....	ground forces intelligence
<b>EEGS</b> .....	enhanced envelope gunsight	<b>GFIS</b> .....	ground forces intelligence survey
<b>EID</b> .....	electronic identification	<b>GLOC</b> .....	G-induced loss of consciousness
<b>EL BAR</b> .....	elevation bar	<b>GLO</b> .....	ground liaison officer
<b>ELV</b> .....	elevation	<b>GM</b> .....	ground map
<b>EO</b> .....	electro-optical	<b>GMT</b> .....	ground moving target (MFD mnemonic for GMTI)
<b>EOR</b> .....	end of runway	<b>GP</b> .....	general purpose
		<b>GPS</b> .....	global positioning system

<b>GR</b> .....	radial G	<b>LMD</b> .....	left miscellaneous display (FCNP mnemonic)
<b>GS</b> .....	ground speed/glide slope	<b>LOC</b> .....	line of communication
<b>HADB</b> .....	high altitude dive bomb	<b>LOS</b> .....	line of sight
<b>HARTS</b> .....	horn awareness and recovery training series	<b>LUU</b> .....	launch unit universal
<b>HCA</b> .....	heading crossing angle	<b>M</b> .....	fuze designator
<b>HEI</b> .....	high explosive incendiary	<b>MM</b> .....	millimeter
<b>HHQ</b> .....	higher headquarters	<b>MAP</b> .....	minimum attack perimeter
<b>HOM</b> .....	home mnemonic	<b>MD</b> .....	miss distance
<b>HSI</b> .....	horizontal situation indicator	<b>METRO</b> .....	pilot to metro voice call
<b>HST</b> .....	target history mnemonic	<b>MFD</b> .....	multifunction display
<b>HUD</b> .....	head-up display	<b>MFL</b> .....	maintenance fault list
<b>IAW</b> .....	in accordance with	<b>MiG</b> .....	Mikoyan Gurevich (Soviet aircraft designator)
<b>IMC</b> .....	instrument meteorological conditions (IAW AFI 11- 206)	<b>MIL</b> .....	military power
<b>INS</b> .....	inertial navigation system/set	<b>mil(s)</b> .....	milliradian(s)
<b>INSM</b> .....	inertial navigation system memory	<b>min</b> .....	minute or minimum
<b>IP</b> .....	initial point or instructor pilot	<b>MISC</b> .....	miscellaneous
<b>IPP</b> .....	initial pipper placement	<b>MK</b> .....	mark (Navy weapon designation)
<b>IR</b> .....	infrared	<b>MPC</b> .....	mission planning cell
<b>JETT</b> .....	jettison	<b>MRA</b> .....	minimum release altitude
<b>JFS</b> .....	jet fuel starter	<b>MRGS</b> .....	multiple reference gunsight
<b>JMEM</b> .....	Joint Munitions Employment Manual	<b>MSA</b> .....	minimum safe altitude
<b>KCAS</b> .....	knots calibrated airspeed	<b>MSL</b> .....	missile mode or missile or mean sea level
<b>KIAS</b> .....	knots indicated airspeed	<b>MSS</b> .....	mission support system
<b>KIO</b> .....	knock it off	<b>MTR</b> .....	moving target reject
<b>KTAS</b> .....	knots true airspeed	<b>MTT</b> .....	multi-target track
<b>Kt(s)</b> .....	knot(s)	<b>NAM</b> .....	normal air mode
<b>LAB</b> .....	low angle bomb	<b>NAV</b> .....	navigation mode
<b>LADD</b> .....	low altitude drogue delivery	<b>NB</b> .....	narrow band
<b>LAHD</b> .....	low angle high drag	<b>NLT</b> .....	not later than
<b>LALD</b> .....	low angle low drag	<b>NM</b> .....	nautical miles
<b>LANTIRN</b> .....	low altitude navigation and targeting infrared night	<b>NORDO</b> .....	.no operative radio
<b>LAS</b> .....	low angle strafe	<b>NORM</b> .....	normal
<b>LAT/LNG</b> .....	latitude/longitude	<b>NSTL</b> .....	nose/tail arming mnemonic
<b>LCOS</b> .....	lead computing optical sight	<b>NVP</b> .....	navigation pod
<b>LDGP</b> .....	low drag general purpose	<b>NWS</b> .....	nose wheel steering
<b>LLLD</b> .....	low level low drag	<b>OA1</b> .....	offset aimpoint #1
		<b>OA2</b> .....	offset aimpoint #2
		<b>OAP</b> .....	offset aimpoint
		<b>OPSEC</b> .....	operations security

<b>OPT</b> .....	option	<b>SID</b> .....	standard instrument departure
<b>OVRD</b> .....	override	<b>SIM</b> .....	simulated
<b>PDP</b> .....	pull-down point	<b>sin</b> .....	sine
<b>PIREP</b> .....	pilot report	<b>SLAV</b> .....	slaved AIM-9L/M SMS mnemonics
<b>Pk</b> .....	probability of kill	<b>SMS</b> .....	stores management system or set
<b>P<sub>s</sub></b> .....	specific power	<b>SNAP</b> .....	snapshot
<b>PGM</b> .....	precision guided munition	<b>SOI</b> .....	sensor of interest
<b>POM</b> .....	plane of motion	<b>SPOT</b> .....	AIM-9L/M non-nutating mode
<b>PUP</b> .....	pull-up point or pop-up point	<b>SS</b> .....	snapshot
<b>PW</b> .....	Pratt and Whitney	<b>SSLC</b> .....	snapshot & lead computing optical sight mnemonic
<b>R</b> .....	turn radius	<b>STBY</b> .....	standby mnemonic
<b>RCP</b> .....	radar control panel	<b>STRF</b> .....	strafe mnemonic
<b>RDR</b> .....	radar	<b>STT</b> .....	single target track
<b>RDY</b> .....	ready mnemonic	<b>TACAN</b> .....	tactical air navigation
<b>REL</b> .....	release mnemonic	<b>TAS</b> .....	true air speed
<b>REO</b> .....	radar/electro-optical	<b>tan</b> .....	tangent
<b>RMD</b> .....	right miscellaneous display (FCNP mnemonic)	<b>TCTO</b> .....	time compliance technical order
<b>ROE</b> .....	rules of engagement	<b>TD</b> .....	target designate
<b>RP</b> .....	release point	<b>TDA</b> .....	tactical decision aid
<b>RTB</b> .....	return to base	<b>TF</b> .....	terrain following
<b>RTN TO SRCH</b> .....	return to search (switch position)	<b>TFR</b> .....	terrain following radar
<b>RTS</b> .....	return to search	<b>TGP</b> .....	targeting pod
<b>RWR</b> .....	radar warning receiver	<b>TGT</b> .....	target
<b>RWS</b> .....	range while search	<b>TIMS</b> .....	time/inertial/map/scope
<b>SA</b> .....	surface attack or situation(al) awareness	<b>TLL</b> .....	target locator line
<b>SACM</b> .....	selectable air combat mode	<b>TOF</b> .....	time-of-flight; time-of-fall
<b>SAM</b> .....	surface-to-air missile	<b>TOS</b> .....	time over steerpoint or time on station
<b>SBC</b> .....	symbology, brightness, and contrast	<b>TOT</b> .....	time over target
<b>SCAN</b> .....	AIM-9L/M nutating mode mnemonics	<b>TWS</b> .....	track-while-scan
<b>SCP</b> .....	stores control panel	<b>UAP</b> .....	upwind aimpoint
<b>SEA</b> .....	sea search mode	<b>UFC</b> .....	upfront controls
<b>SEAD</b> .....	suppression of enemy air defenses	<b>UHF</b> .....	ultra-high frequency
<b>SEL</b> .....	select or selective	<b>V</b> .....	velocity
<b>SFO</b> .....	simulated flameout pattern and approach	<b>V<sub>c</sub></b> .....	closing velocity
<b>SGL</b> .....	single	<b>VAH</b> .....	velocity/altitude/heading (switch)



<b>VCRP</b> .....	CCRP with a VRP (F-16A HUD mnemonic)	<b>VRP-to-PUP</b> .....	visual reference point to pull up point
<b>VHF</b> .....	very high frequency (radio)	<b>VRP-to-TGT</b> .....	visual reference point to target
<b>VID</b> .....	visual identification	<b>VRP/VIP</b> .....	visual release point/visual initial point
<b>VIP</b> .....	visual initial point	<b>VTR</b> .....	video tape recorder
<b>VIP-TO-PUP</b> .....	visual initial point to pull up point (DED page)	<b>VVI</b> .....	vertical velocity indicator
<b>VIP-TO-TGT</b> .....	visual initial point to target (DED page)	<b>WB</b> .....	wide band
<b>VMC</b> .....	visual meteorological conditions	<b>WEZ</b> .....	weapons employment zones
<b>VR</b> .....	visual reconnaissance	<b>WOC</b> .....	wing operations center
<b>VRP</b> .....	visual release point	<b>WPN</b> .....	weapon (mnemonic)
<b>VRPCRP</b> .....	CCRP with a VRP (F-16C HUD mnemonic)	<b>WPN DEL</b> .....	weapon delivery (switch position)
<b>VRPLAD</b> .....	LADD with a VRP (F-16C HUD mnemonic)	<b>WR</b> .....	weapon release



## Attachment Two

### GLOSSARY

The following is a glossary of terms and definitions commonly used in the F-16. The primary reference for terms and definitions is MCM 3-1, Volume 1.

<b>ACA (Airspace Coordination Area)</b>	A three-dimensional box in the sky defined by grid and/or land references and an altitude block (AGL). The intent of an ACA is to allow simultaneous attack of targets near each other by multiple fire support means, one of which is air.
<b>ACBT</b>	Air Combat Training; a general term which includes (D)BFM, (D)ACM, and (D)ACT.
<b>Acceleration Maneuver</b>	An offensive or defensive maneuver, flown in the vertical plane, if possible, designed to increase or reduce distance from an object. A low yo-yo is an acceleration maneuver.
<b>ACM</b>	Air combat maneuvering; training designed to achieve proficiency in element formation maneuvering and the coordinated application of BFM to achieve a simulated kill or effectively defend against one or more aircraft from a preplanned starting position.
<b>ACO</b>	Airspace Control Order; document that details all approved airspace requests. The ACO will complement the ATO cycle and serve as a single planning document for airspace considerations.
<b>ACT</b>	Air combat tactics; training in the application of BFM and ACM skills to achieve a tactical air-to-air objective.
<b>Adverse Yaw</b>	The tendency of an aircraft to yaw away from the applied aileron while at high angles of attack.
<b>Advisory Control</b>	A mode of control in which the controlling agency has communications but no radar capability.
<b>Aerodynamic Center</b>	(A point on the wing chord through which aircraft lift is directed.) This definition is really for the center of pressure. The aerodynamic center is usually defined as the point on the longitudinal axis of the airplane where the lift vector is centered. The distance between the aerodynamic center and the center of gravity is static margin, and is the major factor affecting the longitudinal static stability of the aircraft.
<b>AHC</b>	Aircraft handling characteristics; training designed to gain proficiency in and to exploit the flight envelope of the aircraft, consistent with operational and safety constraints.
<b>Air Refueling Time</b>	Planned lapsed time from the ARCT to drop off.
<b>Air Refueling Track</b>	A flight path designated for air refueling.
<b>Airborne Order</b>	A command authorization for tactical flight (departure time will be specified).

<b>Angle of Attack (AOA)</b>	The angle between the mean chord line and the relative wind.
<b>Angle Off</b>	The angle formed by the extension of the longitudinal axes of two aircraft. Angle is measured from defender's six o'clock. Also called track crossing angle.
<b>Arcing</b>	Flying a circular flight path which allows another aircraft the use of cutoff to gain closure.
<b>ARCP</b>	Air refueling control point; the planned geographic point over which the receiver(s) arrive in the observation/precontact position with respect to the assigned tanker.
<b>ARCT</b>	Air refueling control time; the planned time that the receiver and tanker will arrive over the ARCP.
<b>ARIP</b>	Air refueling initial point; a point located upstream from the ARCP.
<b>Armament Safety Check</b>	Action taken by an aircrew to review armament selection switches to preclude the inadvertent launch/release of armament (switches safe).
<b>Aspect Angle</b>	Angle between defender's longitudinal axis and the line of sight to the attacker. The angle is measured from the defender's six o'clock. Attacker heading is irrelevant.
<b>Attack Restriction</b>	Ingress, ordnance delivery, or egress restrictions depending on situation, i.e., threats, weather, terrain, training rules, etc.
<b>BFM</b>	Basic Fighter Maneuvers; training designed to apply aircraft handling skills to gain proficiency in recognizing and solving range, closure, aspect, angle off, and turning room problems in relation to another aircraft to either attain a position from which weapons may be employed, deny the adversary a position from which weapons may be launched, or defeat weapons employed by the adversary.
<b>BRA</b>	Bearing, range, and altitude of the target.
<b>Break Away</b>	Tanker/receiver call indicating immediate vertical and horizontal separation between tanker and receiver is required.
<b>Broadcast Control</b>	A mode of control that passes target information by referencing a designated location, series of locations, or grid system.
<b>Buffer Zone (BZ)</b>	Airspace of defined dimension and adjacent to or near orders which may have special restrictions.
<b>CAP</b>	Combat Air Patrol; Refers to either a specific phase of an air-to-air mission or the geographic location of the fighter's surveillance orbit during an air-to-air mission prior to committing against a threat.
<b>Center of Gravity (CG)</b>	That point along the horizontal axis, fore and aft of which airplane weight is equal.

<b>Chaff</b>	Chaff is a passive form of electronic countermeasures used to deceive airborne or ground based radar.
<b>C<sub>L</sub> Max</b>	Maximum coefficient of lift; occurs at that angle of attack at which lift is maximum, thereby creating the maximum turn rate and maximum G loading for any condition of flight.
<b>Clock code</b>	Description of position using the aircraft as a reference; the nose is twelve o'clock, the tail is six o'clock.
<b>Close Control</b>	A mode of control varying from providing vectors to providing complete assistance including altitude, speed, and heading.
<b>Closure</b>	Relative velocity of one aircraft in relation to another.
<b>Collision Course</b>	A flight path along which an aircraft is directed towards a point at which it will collide with another aircraft.
<b>Comm Jamming</b>	Attempt to interrupt communications.
<b>Comparison Diagram</b>	A chart comparing turn rate, radius, and excess power for two different aircraft.
<b>Compass Call</b>	A C <sup>3</sup> CM platform.
<b>Composite Force Training</b>	Scenarios employing multiple flights of the same or different types of aircraft, each under the direction of its own flight leader, and performing the same or different roles. Requires a minimum of three different types of aircraft in three different mission roles.
<b>Condition of Vulnerability</b>	A condition with the defender in the lethal envelope of the attacker's weapon system. It is possible for combatants to arrive at a mutual condition of vulnerability, particularly during a head-on pass.
<b>Corner Velocity</b>	The minimum airspeed at which the maximum allowable aircraft G limit can be generated.
<b>Defensive Maneuvering</b>	Maneuvers designed to negate the attack/ordnance of a threat.
<b>Defensive Spiral</b>	A descending, accelerating dive using high G and continuous roll to negate an attack and gain lateral separation.
<b>DR</b>	Dead reckoning; navigation technique estimating position based on last known position, heading, speed, and time.
<b>E-Pole</b>	The range from a threat aircraft that a drag must be accomplished to kinematically defeat any missile the bandit could have launched or is launching.
<b>ECM</b>	Electronic countermeasures; actions taken to prevent or reduce the effective use of the electro-magnetic spectrum.
<b>Element</b>	A flight of two aircraft.
<b>Engagement</b>	Maneuvers by opposing aircraft attempting to achieve/prevent weapons firing positions.

<b>F-Pole</b>	The distance from the launching aircraft to the target at missile impact.
<b>HCA</b>	Heading crossing angle; the angle formed by the intersection of the fighter's present heading and the target's present heading.
<b>High Angle (Snap) Shot</b>	A gun shot made with a high track crossing angle, normally attempted because a tracking shot was not possible or desired.
<b>Hostile</b>	A contact positively identified as enemy in accordance with command rules of engagement.
<b>Hunter-Killer</b>	Flight mix of F-4G Wild Weasel and other aircraft employed in SEAD operations.
<b>Intercept</b>	A phase of an air-to-air mission between the commit and engagement.
<b>Jinking</b>	Aircraft maneuvers designed to change the flight path of the aircraft in all planes at random intervals (usually to negate a gun attack).
<b>Lag Pursuit</b>	An attack geometry that will cause the attacker to fly behind the target.
<b>Lateral (Pitch) Axis</b>	A reference line running left and right through the center of gravity of an airplane.
<b>Lead Pursuit</b>	An attack geometry that will cause the attacker to fly in front of the target.
<b>Lethal Envelope</b>	The envelope within which the parameters can be met for successful employment of a munition by a particular weapons system.
<b>Line of Sight</b>	A line from the pilot's eye to the object (usually target) being viewed.
<b>Line of Sight Rate</b>	An image's rate of movement across the canopy.
<b>Line Up</b>	Fighter briefing to a FAC.
<b>Longitudinal (Roll) Axis</b>	A reference line running fore and aft through the center of gravity of an airplane.
<b>Lufberry</b>	A circular stagnated fight with no participant having an advantage.
<b>Maneuverability</b>	The ability to change direction and/or magnitude if the velocity vector.
<b>Maximum Performance</b>	The best possible performance without exceeding aircraft limitations.
<b>Maximum Rate Turn</b>	That turn at which the maximum number of degrees per second is achieved.
<b>MiG</b>	Fighter aircraft designed and produced by the Mikoyan Gurovich Aircraft Bureau.
<b>Military Crest</b>	A position along a ridge or hill two-thirds the distance from the base to the summit.
<b>Mixed Force</b>	The employment of a single flight of different types of aircraft, performing the same tactical role, under the direction of a single flight leader.

<b>Mutual Support</b>	The coordinated efforts of two or more aircraft to provide combined firepower and survivability.
<b>Off-Station</b>	Not in position.
<b>Offensive Maneuvering</b>	Maneuvers against an opponent to achieve weapons parameters.
<b>On-Station</b>	In position, ready for mission employment.
<b>Ops Check</b>	Periodic check of aircraft systems performed by the aircrew (including fuel) for safety of flight.
<b>Popeye/IMC</b>	Flying in clouds or area of reduced visibility.
<b>Primary Force</b>	The flight(s) that are being protected/escorted.
<b>Pure Pursuit</b>	An attack geometry that will cause the attacker to fly directly at the target.
<b>Radial G</b>	Effective "turning" G.
<b>Rate of Turn</b>	Rate of change of heading, normally measured in degrees per second.
<b>Relative Wind</b>	The oncoming, instantaneous wind. For practical purposes, the direction of the relative wind is exactly opposite the flight path of the airplane.
<b>Sandwich</b>	A situation where the defending aircraft/element finds itself in between the attacking element.
<b>Sanitize</b>	Area clear of threats.
<b>Scissors</b>	A maneuver in which a series of hard turn reversals are executed in an attempt to achieve the offensive after an overshoot by an attacker.
<b>Scramble</b>	Takeoff as quickly as possible.
<b>Scramble Order</b>	Command authorization for combat flight establishing an immediate departure time.
<b>SEAD</b>	Suppression of enemy air defenses.
<b>Semiactive</b>	A system wherein the receiver uses radiation or reflections from the target which has been illuminated by an outside source.
<b>Separation</b>	Distance between an attacker and defender; can be lateral, longitudinal, or vertical.
<b>Slice</b>	Maximum performance, nose-low turn. Usually performed at or near maneuver speed (corner velocity) with nose lowered sufficiently to maintain airspeed. This maneuver falls between a horizontal turn and a split-S.
<b>Sorting</b>	Using any available information such as radar presentation, GCI information, etc., to determine which bandit to attack.
<b>Specific Energy</b>	Total Mechanical energy per pound. Can be loosely described as an airplane's total energy resulting from airspeed and altitude.

<b>Specific Excess Power (<math>P_s</math>)</b>	A measure of an airplane's ability to gain or lose energy in terms of altitude, airspeed, or combination thereof. Also called energy rate and expressed in feet per second or knots per second.
<b>Split-Plane Maneuvering</b>	Aircraft or elements maneuvering in relation to one another, but in different planes and/or altitudes.
<b>Strike</b>	An attack which is intended to inflict damage, seize, or destroy an objective.
<b>Suppressor</b>	Aircraft designated to employ ordnance against defenses.
<b>TAC-A (Tactical Air Coordinator-Airborne)</b>	An airborne agency located far enough away from threats and jamming to provide a communications relay between fighters, FACs, and ground agencies. Typically aboard a FAC aircraft, ABCCC, or AWACS.
<b>Tactical Control</b>	A mode of control similar to close control with regard to type information provided except vectors are not provided to the aircrew by the weapons controller.
<b>Velocity Vector</b>	A line representing the direction and magnitude of the path of travel.
<b>Vertical (Yaw) Axis</b>	A reference line running up and down through the center of gravity of an airplane.
<b>Vertical Rolling Scissors</b>	A defensive descending rolling maneuver in the vertical plane executed in an attempt to achieve an offensive position on the attacker.
<b>Weapons System</b>	In regard to an airplane, weapons system refers to the combination of airplane/pilot/ordnance/ground crew/avionics, etc. (See USAF Glossary of Standardized Terms for complete definition.)
<b>Whifferdill</b>	A maneuver used to change direction approximately 180°. Nose is raised 30° to 60°, then 90° + bank is used to reverse direction of flight and pull nose down below horizon.
<b>Wild Weasel</b>	Dedicated radar defense suppression aircraft.
<b>Willy Pete</b>	A white phosphorus smoke, rocket, grenade, or artillery round used to provide a ground reference. Can be employed as a bomb to provide a smokescreen.



## Attachment Three

### CODE AND BREVITY WORDS

The following is a list code and brevity words for use during combat and daily training flights. It is intended to provide common understanding and minimize radio transmissions. This common understanding is dependent on the following rules:

- These lists are not all inclusive.
- Words listed below should be used in lieu of words or phrases with similar definitions.
- Some words are informational in nature while others are intended to direct action.
- When a flight lead makes directive calls, the wingman must respond with the directed action to the best of his ability.
- If the wingman uses a "directive" term/word, it is a request and the flight lead reserves the right to approve/deny the wingman's requested action.
- When working with allied nations, remember that some of the terms/words listed here may have different meanings.
- In all cases, MCM 3-1, Volume 1 is the primary and directive reference for code and brevity words.

<b>ABORT</b>	Directive to cease action/attack/event/mission.
<b>ACTION</b>	Directive to perform a prebriefed attack sequence or maneuver.
<b>ALPHA CHECK</b>	Request for bearing and range to described point.
<b>ANCHOR</b>	Orbit about a specific point; ground track flown by tanker. Information call indicates a turning engagement about a specific location.
<b>ANGELS</b>	Height of aircraft in thousands of feet.
<b>APEX/ALAMO</b>	Training term used to denote simulated launch of enemy, all-aspect radar missile.
<b>ARM/ARMED (Safe/Hot)</b>	Select armament (safe/hot), or armament is safe/hot.
<b>AS FRAGGED</b>	Fighter, FAC, mission package, or agency will be performing exactly as stated by the air tasking order.
<b>ASPECT</b>	Request/comment regarding target aspect information.
<b>APHID/ARCHER</b>	training term used to denote simulated launch of enemy heat seeking missiles.
<b>ATTACK/ATTACKING ( )</b>	Indicates air-to-surface attack on a specific ground target.
<b>AUTHENTICATE ( )</b>	To request or provide a response for a coded challenge.
<b>AUTONOMOUS</b>	Aircrew is operating without benefit of GCI/AWACS control.
<b>BANDIT (Radar/Heat/Striker)</b>	Known enemy aircraft and type ordnance capability, if known.
<b>BASE (Number)</b>	Reference number used to indicate such information as headings, altitudes, fuels, etc.
<b>BEAM/BEAMER (Direction)</b>	Aircraft maneuvering stabilized within 70—110° aspect; generally given with cardinal directions; east, west, north, south.

<b>BELLY CHECK</b>	A momentary unloaded bank to check the blind side of a turning aircraft.
<b>( ) BENT</b>	Identified system inoperative.
<b>BINGO</b>	Fuel state at which RTB must commence.
<b>BLIND</b>	No visual contact with friendly aircraft; opposite of term "VISUAL."
<b>BLOW THROUGH</b>	Directive/informational call that indicates aircraft will continue straight ahead at the merge and not turn with target/targets.
<b>BOGEY</b>	A radar/visual contact whose identity is unknown.
<b>BOGEY DOPE/DOPE</b>	Request for target information as briefed/available.
<b>BONE</b>	Term used to indicate the formation will remain in a racetrack-type holding pattern (with all wingmen's turns into lead); exit formation must be specified by lead.
<b>BOX</b>	Groups/contacts/formations in a square or offset square.
<b>BRACKET</b>	Indicates geometry where aircraft will maneuver to a position on opposing sides either laterally or vertically from the target.
<b>BREAK (Up/Down/Right/Left)</b>	Directive to perform an immediate maximum performance turn in the indicated direction. Assumes a defensive situation.
<b>BREVITY</b>	Term used to denote radio frequency is becoming saturated/degraded and briefer transmissions must follow.
<b>BROADCAST</b>	Request/directive to switch to broadcast control.
<b>BROKE LOCK</b>	Loss of radar/IR lock-on (advisory).
<b>BUDDY LOCK (Position/Azimuth)</b>	Receiving friendly AI RWR.
<b>BUGOUT (Direction)</b>	Separation from that particular engagement/attack; no intent to reengage.
<b>BULL'S EYE</b>	An established reference point from which the position of an aircraft can be determined.
<b>BUMP</b>	A fly-up to acquire line of sight to the target or laser designation.
<b>BURNER</b>	Directive to select/deselect afterburner.
<b>BUZZER</b>	Electronic communications jamming.
<b>CAP/CAP (Location)</b>	An orbit at a specified location. Establish a combat air patrol at (location).
<b>CHAFF</b>	Call indicating chaff has been detected or to deploy chaff.
<b>CHAMPAGNE</b>	An attack of three distinct groups with two in front and one behind. The leading two groups are attempting to bracket with the trailing third group flying up the middle.
<b>CHATTERMARK</b>	Begin using briefed radio procedures to counter comm jamming.

<b>CHECK ( )</b>	A directive statement made to momentarily monitor (specified items/systems). No response is required if status is normal.
<b>CHECK ( _°Left/_°Right)</b>	Turn ( ) degrees left/right and maintain new heading.
<b>CHICKS</b>	Friendly fighter aircraft.
<b>CHRISTMAS TREE</b>	Directive to briefly turn on exterior lights to enable visual acquisition.
<b>CIRCLE ( )</b>	Flight lead directed defensive maneuver in which the flight establishes a circular holding pattern for mutual support.
<b>CLEAN</b>	No radar contacts.
<b>CLEARED</b>	Requested action is authorized (no engaged/support roles are assumed).
<b>CLEARED DRY</b>	Ordnance release not authorized.
<b>CLEARED HOT</b>	Ordnance release is authorized.
<b>CLOSING</b>	Bandit/bogey/target is getting closer in range.
<b>COLD</b>	In context; attack geometry will result in a pass or roll out behind the target; or, on a leg of a CAP pointed away from the anticipated threats. Air-to-surface, dry or no ordnance attack.
<b>COMEBACK (Left/Right)</b>	Directive to reverse course.
<b>COME OFF (Left/Right/High/Low)</b>	A directive to maneuver as indicated to either regain mutual support or to deconflict flight paths for an exchange of engaged and supporting roles. Implies both "visual" and "tally."
<b>COMMITTED/COMMIT</b>	Fighter intent to engage/intercept; weapons director continues to provide information.
<b>CONTACT</b>	Radar/IR contact at the stated position; should be in bearing, range, altitude (BRA), bull's eye, or geographic position format.
<b>CONTINUE</b>	Maneuver for attack; does not imply clearance to engage or expend ordnance.
<b>COVER</b>	Directive to assume briefed support position and responsibilities.
<b>CRANK (Direction)</b>	F-pole maneuver; implies illuminating target at radar gimbal limits.
<b>CROSS TURN/CROSS</b>	A 180° heading reversal by a flight where aircraft turn into each other.
<b>CUTOFF</b>	Request for, or directive to, intercept using cutoff geometry.
<b>DEADEYE</b>	Informative call by an airborne laser designator indicating the laser is inoperative.
<b>DEFENSIVE (Spike/Missile/SAM/Mud/AAA)</b>	Aircraft is in a defensive position and maneuvering with reference to the stated condition. If no condition stated, maneuvering is with respect to air-to-air threat.
<b>DEPLOY</b>	Directive for the flight to maneuver to briefed positioning.

<b>DIVERT</b>	Proceed to alternate mission/base.
<b>DOLLY</b>	Data link equipment.
<b>DRAG/DRAGGING (Direction)</b>	Aircraft maneuver to 60° or less aspect.
<b>ECHELON (Cardinal Direction)</b>	Groups/contacts/formation with wingman displaced approximately 45° behind leader's wing line.
<b>ELEMENT</b>	Formation of two aircraft.
<b>ENGAGED</b>	Maneuvering with the intent of achieving a kill. If no additional information is provided (bearing, range, etc.), engaged implies visual/radar acquisition of the target.
<b>ESTIMATE</b>	Using information available to provide required data; implies degradation.
<b>EXTEND (Direction)</b>	Directive to gain energy and distance with the possible intent of returning.
<b>EYEBALL</b>	Fighter with primary visual identification responsibility.
<b>FADED</b>	Previous radar contact lost.
<b>FAST</b>	Target speed is estimated to be 600 knots ground speed, Mach 1 or greater.
<b>FEET WET/DRY</b>	Flying over water/land.
<b>FENCE</b>	Boundary separating hostile and friendly area.
<b>FENCE CHECK</b>	Set cockpit switches as appropriate.
<b>FEW</b>	Two to four aircraft.
<b>FLANK/FLANKING</b>	Target with a stable aspect of 120—150°.
<b>FLOAT</b>	Directive/informative to expand the formation laterally within visual limits to maintain a radar contact or prepare for a defensive response.
<b>FLUSH/FLUSHED</b>	Precautionary launch or aircraft for survival.
<b>FOLLOW DOLLY</b>	Follow data-link commands.
<b>FOX</b>	Air-to-air weapons employment.
<b>FOX ONE</b>	Simulated/actual launch of semi-active radar-guided missile.
<b>FOX TWO</b>	Simulated/actual launch of IR-guided missile.
<b>FOX THREE</b>	Simulated/actual launch of an active radar-guided missile.
<b>FOX MIKE</b>	VHF/FM radio.
<b>FURBALL</b>	A turning fight involving multiple aircraft.
<b>GADGET</b>	Fire control radar.
<b>GIMBALS (Direction)</b>	Radar target is approaching azimuth or elevation limits.
<b>GO ACTIVE</b>	Go to briefed Have Quick net.
<b>GO SECURE</b>	Directive to activate secure voice communications.
<b>GORILLA</b>	Large force of indeterminable numbers and formation.
<b>GREEN (Direction)</b>	Direction determined to be clearest of enemy air-to-air activity.

<b>GROUP</b>	Radar target(s) within approximately 3 NM of each other.
<b>GUN (Direction)</b>	Visual acquisition of gunfire, AAA site, or AAA fire.
<b>GUNS</b>	An air-to-surface gunshot.
<b>HARD (Direction)</b>	High G energy sustaining turn.
<b>HEAD</b>	Target with an aspect of 160180°.
<b>HEADS DOWN</b>	Call to inform aircrew that leader/wingman is head down in the cockpit and leader/wingman is responsible for clearing.
<b>HEADS UP (Direction/Altitude)</b>	Enemy/bogey got through; no kill.
<b>HIGH</b>	Target between 25,000 MSL and 40,000 MSL.
<b>HIT</b>	Radar return in search (air-to-air). Weapons impact within lethal distance (air-to-ground).
<b>HOLD DOWN</b>	Directive to key transmitter for DF steer.
<b>HOLDING HANDS</b>	Aircraft in visual formation.
<b>HOME PLATE</b>	Home airfield.
<b>HOOK (Left/Right)</b>	Directive to perform an in-place 180° turn.
<b>HOT</b>	In context; attack geometry will result in roll out in front of the target; or on a leg of the CAP pointing toward the anticipated threats (air-to-air). Ordnance employment authorized, expected, or completed (air-to-ground).
<b>HOTEL FOX</b>	HF radio.
<b>ID</b>	Directive to intercept and identify the target; also aircrew ID accomplished, followed by type aircraft.
<b>IN PLACE (Left/Right)</b>	Perform indicated maneuver simultaneously.
<b>JINK</b>	Unpredictable maneuvers to negate a tracking solution.
<b>JOKER</b>	Fuel state above bingo at which separation/bugout should begin.
<b>JUDY</b>	Aircrew has radar/visual contact on the correct target, has taken control of the intercept, and only requires situation awareness information; weapons director will minimize radio transmissions.
<b>JUDY ANGLE</b>	Aircrew is taking control of intercept in azimuth only; weapons director continues to provide range information.
<b>KILL</b>	Directive to commit on target with clearance to fire; in training, a fighter call to indicate kill criteria have been fulfilled.
<b>LADDER</b>	Three or more groups/contacts/formations/aircraft side-by-side.
<b>LINE ABREAST</b>	Two groups/contacts/formations/aircraft side-by-side.
<b>LOCKED (BRA/Direction)</b>	Final radar lock-on; sort is not assumed.
<b>LOW</b>	Target altitude below 5,000 feet AGL.
<b>MAGNUM</b>	Launch of AGM-88 HARM by Wild Weasel.
<b>MANY</b>	Five or more aircraft.

<b>MARKING</b>	Leaving contrails or otherwise marking aircraft position.
<b>MEDIUM</b>	Target altitude between 5,000 feet AGL and 25,000 feet AGL.
<b>MERGED</b>	Informative that friendlies and targets have arrived in the same visual arena. Call indicating radar returns have come together.
<b>MICKEY</b>	Have Quick time of day (TOD) signal.
<b>MIDNIGHT</b>	Initiate advisory control (due to loss of GCI-type radar).
<b>MIL</b>	Directive to select military power.
<b>MUD (Direction)</b>	Indicates RWR ground threat displayed; followed normally by clock position.
<b>MUSIC</b>	Electronic radar jamming. On AI radar, electronic deceptive jamming.
<b>NAKED</b>	No RWR indications.
<b>NO JOY</b>	Aircrew does not have visual contact with the target/bandit; opposite of "TALLY."
<b>NOTCH (Direction)</b>	All-aspect missile defensive maneuver to place threat radar/missile near the beam.
<b>OFF (Direction)</b>	Informative that attack is being ceased and repositioning in the indicated direction.
<b>OFFSET (Left/Right)</b>	Informative call indicating maneuver in a specific direction with reference to the target.
<b>PACKAGE</b>	Geographically isolated collection of groups/contacts/formations.
<b>PADLOCKED</b>	Informative that aircrew cannot take eyes off another aircraft/ground target without losing tally.
<b>PAINT</b>	Friendly AAI/APX interrogation return.
<b>PARROT</b>	IFF transponder.
<b>PICTURE</b>	Situation briefing which includes real-time information pertinent to a specific mission.
<b>PIGEONS (Location)</b>	Magnetic bearing and range to a specified point.
<b>PITCHBACK (Left/Right)</b>	A call for fighter/flight to execute a nose-high heading reversal to reposition as stated.
<b>PLAYTIME</b>	Amount of time which aircraft can remain on station.
<b>POINT</b>	Directive for an element to turn towards each other either as a defensive response or to reestablish a mutually supportive formation.
<b>POP</b>	Starting climb for an air-to-surface attack.
<b>POPEYE</b>	Flying in clouds or area of reduced visibility.
<b>POSIT</b>	Request for position; response normally in terms of a geographic landmark, or off a common reference point.
<b>POST ATTACK (Direction)</b>	Weapons director's transmission to indicate desired direction after completion of the intercept/engagement.
<b>POST HOLE</b>	Rapid descending spiral.

<b>POWER</b>	Reminder to set the throttles appropriately considering the IR threat and desired energy state.
<b>PRESS</b>	Directive to continue the attack; mutual support will be maintained. Appropriate engaged and supporting roles will be assumed.
<b>PUMP</b>	Directive to perform a prebriefed sequential maneuver to stop relative forward motion while maintaining situation awareness on the threat.
<b>PURE</b>	Call indicating pure pursuit is being used or directive call to go pure pursuit.
<b>PUSH (Channel)</b>	Go to designated frequency.
<b>RANCH HOUSE (Altitude)</b>	Informative or directive indicating subject fighters will/should return to CAP.
<b>REFERENCE (Direction)</b>	Directive to assume stated heading.
<b>RIFLE</b>	AGM-65 launch.
<b>ROGER</b>	Indicates aircrew understands the radio transmission; does not indicate compliance or reaction.
<b>SAM (Direction)</b>	Visual acquisition of a SAM or SAM launch. Should include position.
<b>SANDWICHED</b>	A situation where an aircraft/element find themselves between opposing elements.
<b>SAUNTER</b>	Fly at best endurance.
<b>SEPARATE</b>	Separation from a specific engagement.
<b>SHACKLE</b>	One weave; a single crossing of flight paths; maneuver to adjust/regain formation parameters.
<b>SHADOW</b>	Follow indicated target.
<b>SHIFT</b>	Directive to illuminate second target with laser designator.
<b>SHOOTER</b>	Aircraft designated to employ ordnance.
<b>SHOTGUN</b>	Launch of antiradiation (SHRIKE) missile by Wild Weasel.
<b>( ) SICK</b>	Described equipment is degraded.
<b>SILENT</b>	"GO SILENT" directive to initiate briefed EMCON procedures.
<b>SKIP IT</b>	Veto of fighter commit call; usually followed with further directions.
<b>SLICE (Left/Right)</b>	Directive to perform a high G descending turn in the stated direction; usually 180° turn.
<b>SLOW</b>	Target with ground speed of less than 300 knots.
<b>SNAP SHOT</b>	High angle/high LOS gun shot.
<b>SNAP ( )</b>	An immediate vector (bearing and range) to the group described.
<b>SORTED</b>	Criteria have been met which ensure individual flight members have separate contacts; criteria can be met visually, electronically (radar) or both.

<b>SPARKLE</b>	Target marking by a gunship or FAC using incendiary rounds.
<b>SPIKE</b>	RWR indication of an AI threat in track, launch, or unknown mode. Include bearing and clock position/azimuth and threat type if able.
<b>SPITTER (Direction)</b>	An aircraft that has departed from the engagement.
<b>SPLASH</b>	Target destroyed (air-to-air); weapons impact (air-to-ground)
<b>SPLIT</b>	Request to engage a threat; visual may not be maintained; requires flight lead acknowledgment (air-to-air). Also, directive to begin prebriefed maneuver/attack.
<b>SPOOFING</b>	Informative that voice deception is being employed.
<b>SPOT</b>	Informative that laser target designation is being received.
<b>SQUAWK ( )</b>	Operate IFF as indicated or IFF is operating as indicated.
<b>STACK</b>	Two or more groups/contact/formation with a high/low stack in relation to each other.
<b>STATUS</b>	Request for an individual's tactical situation; response is normally "offensive," "defensive," or "neutral." May be suffixed by position and heading.
<b>STERN</b>	Request for, or directive to, intercept using stern geometry.
<b>STINGER</b>	Formation of two or more aircraft with a single trail.
<b>STRANGER</b>	Unidentified traffic that is not participant in the mission.
<b>STRANGLE ( )</b>	Turn off equipment indicated.
<b>STROBE</b>	AI radar indications of noise radar jamming.
<b>SUNRISE</b>	A minimum of broadcast control is available (due to return of weapons director's radar).
<b>SUPPORTING</b>	Act of assisting the engaged fighter in killing the bandit while maintaining overall battle situation awareness.
<b>SWITCH/SWITCHED</b>	Indicates an attacker is changing from one aircraft to another.
<b>TALLY</b>	Sighting of a target/bandit; opposite of "NO JOY."
<b>TARGET</b>	Specification of sort responsibility. Directive call that may not necessarily follow the sort contract.
<b>THREAT (Direction)</b>	(GCI/AWACS) Informative that an untargeted bogey is within 10 NM of a friendly.
<b>TIED</b>	Positive radar contact with an element/aircraft.
<b>TRACK</b>	A series of related contacts indicating direction of travel.
<b>TRACKING</b>	Stabilized gun solution.
<b>TRAIN (Formation)</b>	Tactical formation of two or more aircraft following one another.



<b>TRAILER</b>	The last aircraft in a formation.
<b>TUMBLEWEED</b>	Indicates limited situation awareness; no tally, no visual, a request for information.
<b>UNIFORM</b>	UHF/AM radio.
<b>VERY HIGH</b>	Target altitude above 40,000 feet MSL.
<b>VERY LOW</b>	Target altitude is below 300 feet AGL.
<b>VIC</b>	Three groups/contacts/formations with the single closest in range and an element in trail.
<b>VICTOR</b>	VHF/AM radio.
<b>VISUAL</b>	Sighting of a friendly aircraft; opposite of "BLIND."
<b>WALL</b>	Three or more groups/contacts/formations line abreast/side by side.
<b>WEAVE</b>	Continuous crossing of flight paths.
<b>WEDGE</b>	Tactical formation of two or more aircraft with the single in front and the other aircraft laterally displaced on either side behind the leader's wing line.
<b>WEEDS</b>	Indicates that aircraft are operating close to the surface.
<b>( ) WELL</b>	Described equipment is functioning properly.
<b>WHAT LUCK</b>	Request for results of mission/tasks.
<b>WHAT STATE</b>	Request for armament/fuel status; reported as follows: ( ) Radar = # radar missiles remaining. ( ) Heat = # heat missiles remaining. ( ) Fuel = pounds of fuel or time remaining.
<b>WILCO</b>	Will comply with received instructions.
<b>WINCHESTER</b>	No ordnance remaining.
<b>WORDS</b>	Pertinent mission information.
<b>WORKING ( )</b>	Wild Weasel is gathering electronic order of battle on a designated emitter.
<b>ZIPPER</b>	Acknowledge radio transmissions with two clicks of the mike button.